

**INSTRUCTION MANUAL**

---

**AUTO REFRACTOMETER**

**RM-8800**

**AUTO KERATO-REFRACTOMETER**

**KR-8800**



# INTRODUCTION

Thank you for purchasing the Auto Refractometer RM -8800, Auto Kerato-Refractometer KR-8800.

---

This instrument is used to measure the spherical refractive-power, cylindrical refractive power, the direction of astigmatic axis, the radius of curvature, the direction of principal meridian and the corneal refractory power.

## **This instrument features the following:**

- Measures the refractory power of eye and the corneal curvature with simple operations.
  - The minimum measurable pupil diameter is now smaller and thus the measuring range is extended.
  - The auto start function facilitates quick measurements under the optimal condition.
- 

This Instruction Manual covers an overview of the basic operation, troubleshooting, checking, maintenance and cleaning of the Auto Refractometer RM -8800 and Auto Kerato-Refractometer KR-8800.

To get the best use of the instrument, read Safety Displays and Safety Cautions. Keep this Manual at hand for future reference.

---

## PRECAUTIONS

- Since this product is a precision instrument, always use and keep it in a normally controlled living environment, within a temperature range of 10-40°C, humidity levels between 30-75% and an atmospheric pressure range of 700hPa-1,060hPa.  
The instrument should also be placed away from direct sunlight.
- To ensure smooth operation, install the instrument on a level floor free of vibrations. Also, do not put things on the instrument.
- Connect all cables properly before using.
- Use the power at a rated voltage.
- When not in use, switch off the power source and apply the measuring lens cap and dust cover.
- For accurate measurement results, take care to keep the examination window clean and free of fingerprints, spots and dust.

CLASS I  
  
IEC60601-1

  
0123

## **PRECAUTIONS**

### **BASIC INSTRUCTIONS**

To prevent your fingers from getting caught in the instrument, be aware of all moving parts.

### **WORKING ENVIRONMENT**

Temperature: 10°C-40°C  
Humidity: 30-75% (without dew)  
Atmospheric Pressure: 700hPa-1,060hPa

### **STORAGE METHOD**

#### **1. ENVIRONMENTAL CONDITIONS**

Temperature: 10 °C-40 °C  
Humidity: 30-75% (without dew)  
Atmospheric Pressure: 700hPa-1,060hPa

#### **2. IF THE INSTRUMENT IS PLACED IN STRAGE, KEEP IT**

- (1) Free from water splashes
- (2) Free from adverse effects due to atmospheric pressure, temperature, moisture, ventilation, sunlight, dust, salt content, sulfur, etc.
- (3) Stable and free from vibration shock (including transportation) and insure that it is always stored in an upright position.
- (4) Free from chemicals and gases

### **TRANSPORT CONDITION**

Temperature: -20°C-50°C  
Humidity: 10-95%

### **MAINTENANCE AND CHECKS**



- 1.Regularly maintain and check all equipment and parts.
- 2.Before using equipment that has not been used in a while, be sure to confirm normal and safe operation beforehand attempting any patient measurements.
- 3.Keep the examination window free from finger prints and dust.
- 4.When the instrument is not in use, protect the instrument by covering it with the dust cover.
- 5.When the examination window becomes dirty or soiled, clean it according to the instructions listed in "CLEANING THE INSTRUMENT" on page 81 of the Instruction Manual.

# SAFETY DISPLAYS







In order to encourage the safe use of the instrument and to avoid danger to the operator and others as well as damage to properties, warnings are described in the Instruction Manual and marked on the instrument body.

We suggest you thoroughly understand the meaning of the following displays/icons and Safety Cautions, as well as read the Manual, and strictly observe the instructions.

## DISPLAYS

DISPLAY	MEANING
 <b>WARNING</b>	Improper handling or ignoring this display may lead to the danger of death or serious injury.
 <b>CAUTION</b>	Improper handling or ignoring this display may cause personal injury or physical damage.
<ul style="list-style-type: none"><li>• Injury means hurt, burn, electric shock, etc.</li><li>• Physical damage means extensive damage that may involve building, peripheral equipment and furniture.</li></ul>	

## ICONS

ICONS	MEANING
	This icon indicates an action to be avoided. Specific contents are shown with words or illustration close to the  icon.
	This icon indicates Mandatory Action. Specific contents are shown with words or illustration close to the  icon.
	This icon indicates Hazard Alerting (Warning). Specific content are shown with words or illustration close to the  icon.

# SAFETY CAUTIONS









## WARNINGS

Icon	Meaning	Page
	To avoid electric shocks, do not attempt overhauling, rebuilding or repairs. Ask your dealer for repair.	<b>76</b>
	To avoid electric shocks, do not remove covers from bottom and top surfaces, monitor, measuring unit, etc.	<b>76</b>
	To prevent shock hazard, do not allow water or other foreign matter to enter the instrument.	—
	To avoid fire and electric shocks in case of tumbling, do not place a cup or vessel containing water/fluid on the instrument.	—
	To avoid electric shocks, do not insert objects metals through vent holes or gaps or contain them inside the machine body.	—
	To avoid electric shocks during fuse change, be sure to unplug the power cable before removing the fuse lid. Also, do not plug the power cable leaving the fuse box open.	<b>83</b>
	Always use the attached fuse (T-3A,250V). Using any other type may cause troubles and fire.	<b>83</b>
	Should any anomaly, such as smoke, occur, immediately switch OFF the power source and unplug the power cable. Continued use ignoring the condition may cause fire. Ask your dealer for repair.	—

# SAFETY CAUTIONS



## CAUTIONS

Icon	Meaning	Page
	<p>Before moving the instrument, fasten the clamping knob at the bottom surface to stop movements. Negligence of this may cause injury by falling parts.</p>	<p><b>19</b></p>
	<p>When moving the instrument, be sure to hold it at the bottom surface with two persons. Carrying by one person may cause a backache or injury by falling parts. Also, holding area other than the bottom surface may cause pinching fingers between parts and injury by falling parts as well as damage to the instrument.</p>	<p><b>19</b></p>
	<p>To prevent injury due to tumbling of the instrument body and falling parts, avoid a slope and unstable floor for installation.</p>	<p><b>19</b></p>
	<p>To avoid electric shocks, do not handle the power plug with wet fingers.</p>	<p><b>20</b></p>
	<p>To avoid injury, do not insert fingers under the chinrest. *Be sure to instruct the patient about this.</p>	<p><b>57</b></p>
	<p>This instrument has been tested (with 120V/230V) and found to comply with IEC60601-1-2: 2001. This instrument radiates radio frequency energy within standard and may affect other devices in vicinity. If you have discovered that turning on/off the instrument affects other devices, we recommend you change its position, keep a proper distance from other devices, or to change the outlet. Please consult the dealer from whom you purchased the equipment for any questions.</p>	<p>—</p>

# USAGE AND MAINTENANCE

## Usage:

- Since the Auto Refractometer is an electric equipment for medical purposes, the operation should be supervised by a well-experienced doctor.

## **USER MAINTENANCE**

To maintain the safety and performance of the equipment, never attempt to do maintenance and except for the items specified here. For details, follow the instructions.

### **FUSE CHANGE:**

For details, See "FUSE CHANGE" on page 83.

### **CLEANING OF EXAMINATION WINDOW:**

For details, See "CLEANING THE INSTRUMENT" on page 81.

## ESCAPE CLAUSES

- TOPCON shall not take any responsibility for damage due to fire, earthquakes, actions by third persons and other accidents, or the negligence and misuse of the user and use under unusual conditions.
- TOPCON shall not take any responsibility for damage derived from the use or unavailability of this equipment, such as a loss of business profit and suspension of business.
- TOPCON shall not take any responsibility for damage caused by usage other than that described in this Instruction Manual.
- TOPCON shall not take any responsibility for the result of diagnosis using this equipment.



# WARNING INDICATIONS AND POSITIONS

To secure safety, this equipment provides warnings.

Correctly use the equipment following these warning instructions. If any of the following marking labels are missing, please contact your dealer or TOPCON to the address stated on the back cover.

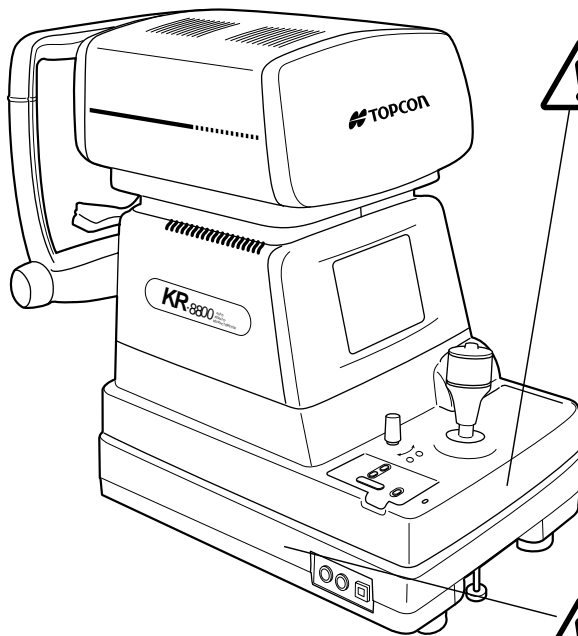

**CAUTION**

- To avoid potential injury during operation, do not touch the patient's eyes or nose with the instrument.

**WARNING**

- To avoid electrical shock, do not open the instrument. Refer all servicing to only qualified personnel.

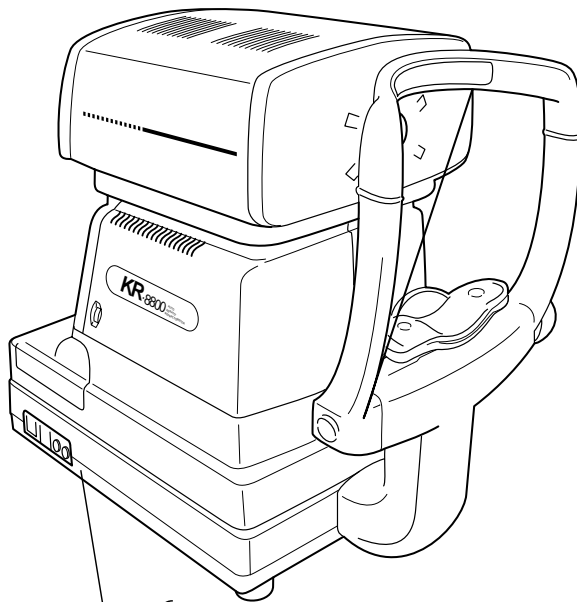

**WARNING**

- Electrical shock may cause burns or possible fire. Turn the main power switch OFF and UNPLUG the power cord before replacing fuses. Replace only with fuses of the correct rating.

# CONTENTS

INTRODUCTION .....	1
PRECAUTIONS.....	2
WORKING ENVIRONMENT.....	2
STORAGE METHOD.....	2
TRANSPORT CONDITION .....	2
SAFETY DISPLAYS .....	3
SAFETY CAUTIONS .....	4
USAGE AND MAINTENANCE .....	6
USER MAINTENANCE.....	6
ESCAPE CLAUSES .....	6
WARNING INDICATIONS AND POSITIONS .....	7

## COMPONENT NAMES

MAIN BODY COMPONENTS.....	10
CONTROL PANEL COMPONENTS.....	11
MONITOR SCREEN.....	13
PRINTER OUTPUT .....	15
STANDARD ACCESSORIES .....	18

## PREPARATIONS

INSTALLATION .....	19
CONNECTING POWER CABLE .....	20
CONNECTING EXTERNAL I/O TERMINALS .....	20
INITIAL SETTINGS.....	21
INITIAL SET SCREEN.....	22
NO. SETTING.....	27
PRINTOUT .....	31
CUSTOM-PRINT SETTINGS .....	35
ON-LINE (DATA COMMUNICATION) .....	41
MENU SETTING.....	44
PRINTER PAPER SETTING .....	50
RESETTING FROM POWER SAVE STATUS .....	56

## BASIC OPERATIONS

PREPARATION BEFORE MEASUREMENT .....	57
MEASUREMENT UNDER AUTO START MODE (ONLY IN KR-8800) .....	59
MEASUREMENT UNDER MANUAL MODE .....	64
ERASING MEASUREMENT VALUES .....	66

## INDIVIDUAL OPERATIONS

PRINT-OUT OF MEASUREMENT VALUES .....	67
MEASUREMENT OF CORNEA DIAMETER (ONLY IN KR-8800) .....	69
MEASUREMENT OF HARD CONTACT LENS.....	73
INPUT/OUTPUT USING RS232C .....	74

## TROUBLESHOOTING

TROUBLE-SHOOTING OPERATIONS.....	75
----------------------------------	----

## **SPECIFICATIONS AND PERFORMANCE**

.....	77
ELECTROMAGNETIC COMPATIBILITY .....	79
ELECTRIC RATING .....	79
SYSTEM CLASSIFICATION .....	79
PURPOSES OF USE .....	79

## **REFERENCE**

OPTIONAL ACCESSORIES.....	80
SHAPE OF PLUG.....	80

## **MAINTENANCE**

DAILY CHECKUPS .....	81
MAINTENANCE.....	84

# COMPONENT NAMES

## MAIN BODY COMPONENTS

### Measuring Head Unit

Measuring Head

Clamping knob

Control panel

External I/O terminal

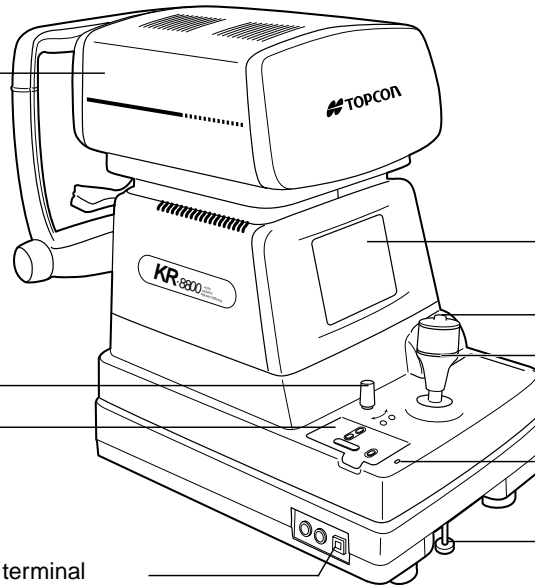

monitor

Measurement switch

Control lever

Base Unit

Power lamp

Clamping knob  
(for movement)

### Chinrest Unit

Brightness volume

Power switch

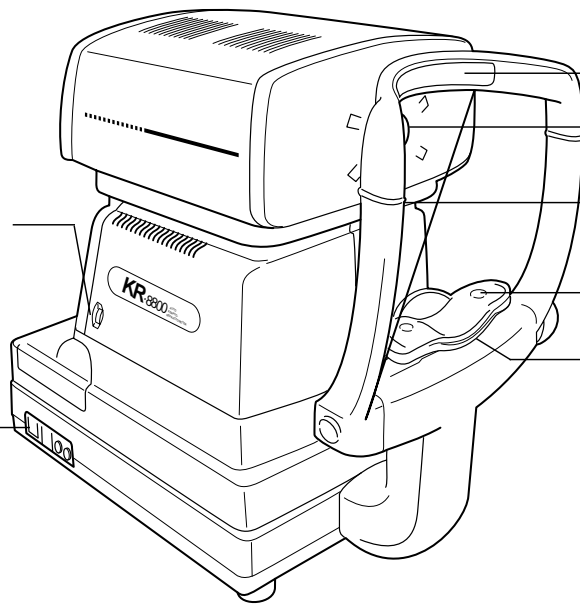

Forehead rest

Examination window

Eye height mark

Chinrest tissue pin

Chinrest







Cap (for examination window)

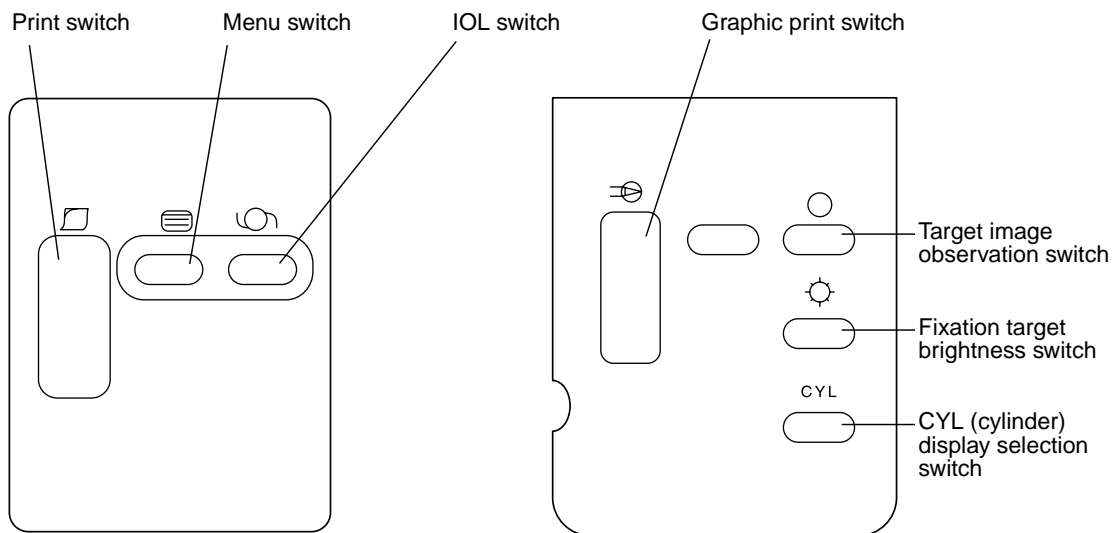

## CONTROL PANEL COMPONENTS







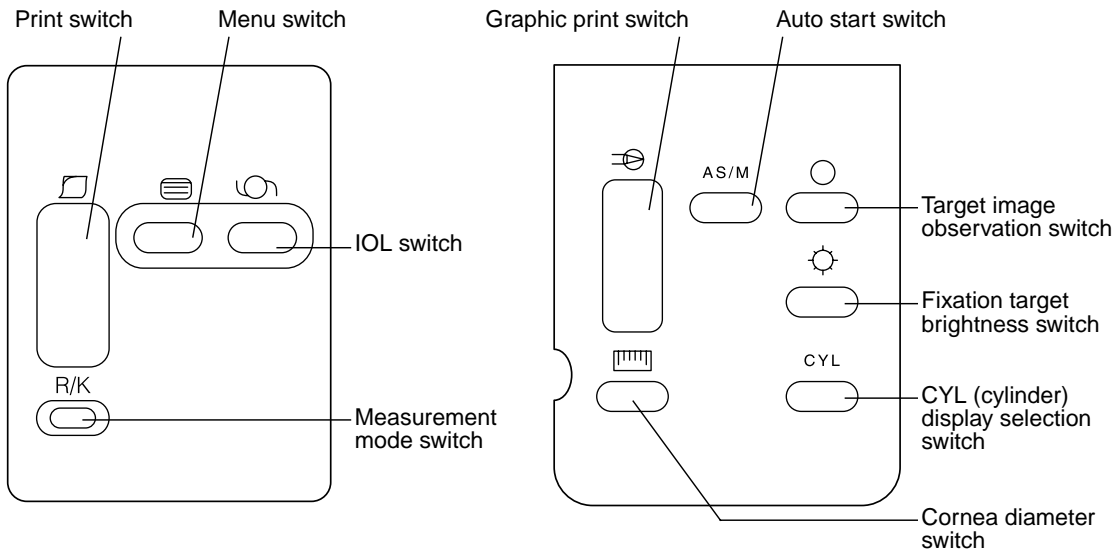

### RM-8800



-  Print switch ..... Prints out the measurement result. When there is no measurement value, press the switch to feed paper.
-  Menu switch ..... Displays the menu screen.
-  IOL switch ..... Press the switch to try measurement when errors are likely, for example, eyes with IOL.
-  Graphic print switch..... Prints out graphically the state of refraction.
-  Target image switch ..... Allows the operator to observe the stored target image on the monitor screen.
-  Fixation target brightness switch... Changes the brightness of fixation target.
- CYL** CYL display selection switch..... Changes the CYL display.

## KR-8800



-  Print switch..... Prints out the measurement result. When there is no measurement value, press the switch to feed paper.
-  Menu switch ..... Displays the menu screen.
-  IOL switch ..... Press the switch to try measurement when errors are likely, for example, eyes with IOL.
-  Graphic print switch..... Prints out graphically the state of refraction.
-  Target image switch ..... Allows the operator to observe the stored target image on the monitor screen.
-  Fixation target brightness switch .... Changes the brightness of fixation target.
- CYL** CYL display selection switch .... Changes the CYL display.
-  Measurement mode switch..... Changes the measurement mode.
- AS/M Auto start switch..... Switch between auto start and manual mode.
-  Cornea diameter switch ..... Measures the cornea diameter.

# MONITOR SCREE



When unreliable, the IOL mode mark blinks.

## RM-8800

### MEASURING SCREEN (LAYOUT 1)

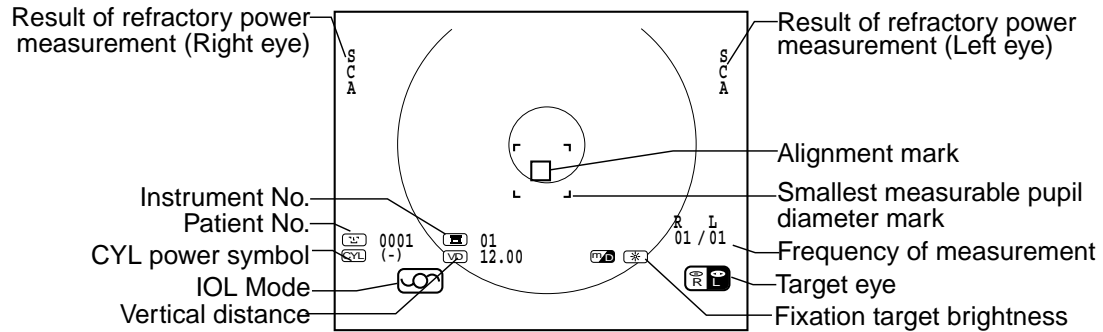

### MEASURING SCREEN (LAYOUT 2)

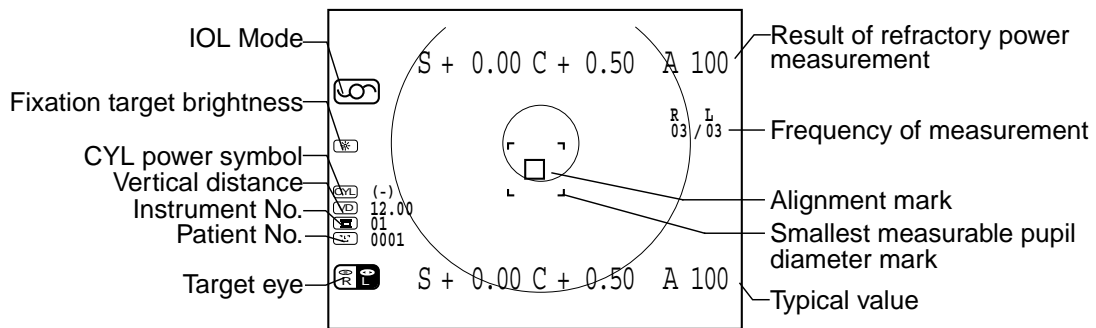

### INITIAL SETTING SCREEN

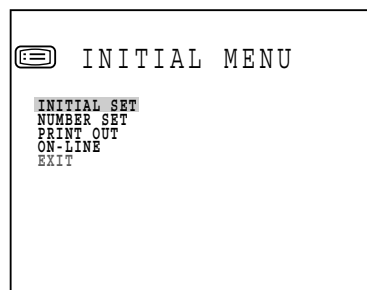

### MENU SETTING SCREEN

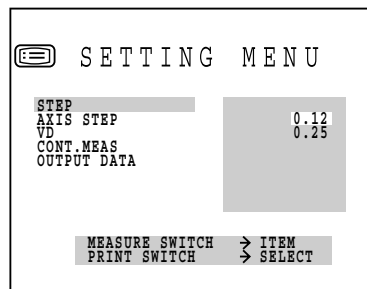

# KR-8800

## MEASURING SCREEN(LAYOUT 1)

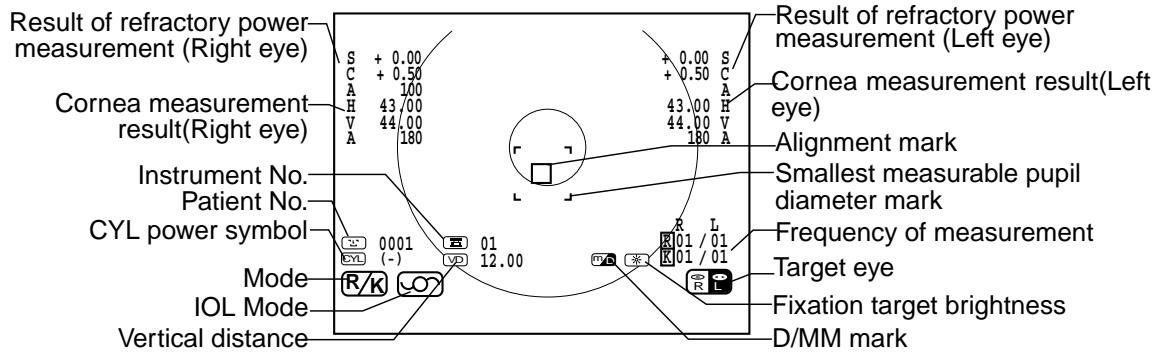

## MEASURING SCREEN(LAYOUT 2)

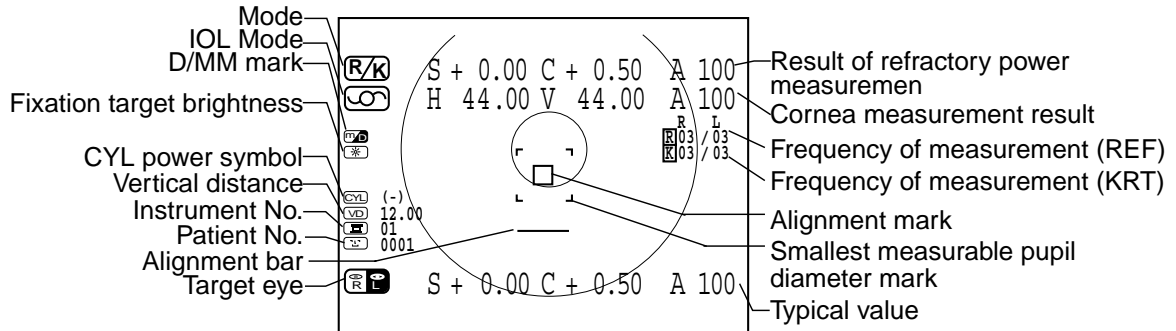

## INITIAL SETTING SCREEN

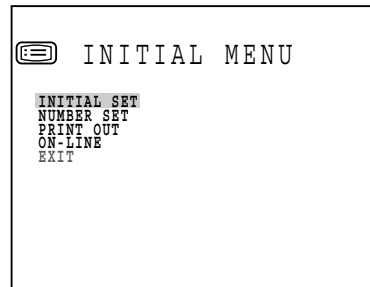

## MENU SETTING SCREEN

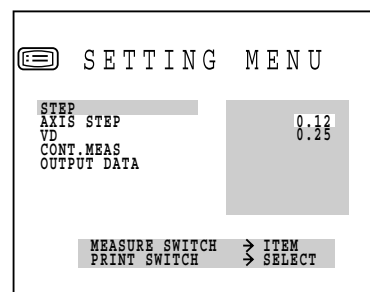

## CORNEA DIAMETER MEASUREMENT SCREEN

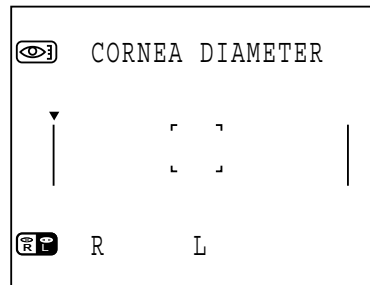



# PRINTER OUTPUT

RM-8800

Bar code

Work ID No. -RM 010602-

NAME

Patient No. 2003\_03\_01 AM 10:00

Instrument No. No. 000101

VD (vertical distance) VD : 12.00

Cylindrical power mark CYL: (-)

Results of 5 refractory power measurements of right eye (recordable up to 10 measurements)

(R)	S	C	A
	-0.25	-0.75	88
	-0.25	-0.75	90
	-0.25	-0.75	90
9	-0.25	-0.75	90
8	-0.25	-0.75	90
	<b>-0.25</b>	<b>-0.75</b>	<b>90</b>
	S.E.	-0.75	

Typical value of right eye

Equivalent spherical power of right eye

Results of 5 refractory power measurements of left eye (recordable up to 10 measurements)

(L)	S	C	A
	(+0.25	-0.75	88)
	+0.25	**	**
I7	+0.25	-0.75	90
I1	+0.25	-0.75	90
I4	+0.25	-0.75	90
	<b>-0.25</b>	<b>-0.75</b>	<b>90</b>
	S.E.	-0.75	

The ( ) mark is added when measurement values are not fully reliable.

The I mark is displayed at IOL mode.

If the reliability is low and values of C and A cannot be determined, \*\* marks are given to pertaining columns.

Typical value of left eye

PD (pupil distance) PD : 65 ADD : 2.25 NPD : 61 TOPCON

Reliability factor



When measurement is done under the IOL mode, a reliability factor is printed out following the I mark.

The reliability factor is formed with integers 1 to 9 in increasing order of reliability. Additionally, if the reliability is high enough, the reliability factor is not shown in the printout.



-KR 010602-

NAME

2003\_03\_01 AM 10:00  
No. 0001 01

**REF. DATA**  
**VD : 12.00**    **CYL: (-)**  
**<R> S    C    A**  
 -0.25 -0.75 88  
 -0.25 -0.75 90  
 -0.25 -0.75 90  
**-0.25 -0.75 90**  
**S.E.** -0.75  
**<L> S    C    A**  
 +0.25 -0.75 88  
 +0.25 -0.75 90  
 +0.25 -0.75 90  
 (+0.25 -0.75 90)  
**-0.25 -0.75 90**  
**S.E.** -0.75  
**PD : 65** **ADD : 2.25** **NPD : 61**

**KRT.DATA**  
**<R> D    MM    A**  
**H** 43.50 7.77 1  
**V** 43.25 7.80 91  
**AVE** 43.25 7.79  
**CYL** -0.25 91  
**CORNEA DIA : 12.00**  
**D1    D2    A1**  
**■1** 43.25 43.50 91  
**■2** 43.25 43.50 93  
**■3** 43.25 43.50 93  
**<L> D    MM    A**  
**H** 43.50 7.77 143  
**V** 43.25 7.80 53  
**AVE** 43.25 7.79  
**CYL** -0.25 53  
**CORNEA DIA : 12.00**  
**D1    D2    A1**  
**■1** 43.25 43.50 103  
**■2** 43.25 43.50 98  
**■3** 43.25 43.50 93  
**■4** \*43.75 44.50 93

TOPCON

ALL mode (example)



When measurement is done under the IOL mode, a reliability factor is printed out following the I mark.  
 The reliability factor is formed with integers 1 to 9 in increasing order of reliability. Additionally, if the reliability is high enough, the reliability factor is not shown in the printout.

<REF> mode

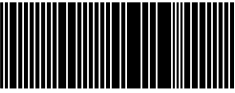

-KR 010602-

NAME

2003\_03\_01 AM 10:00  
No. 0001 01

REF. DATA  
VD : 12.00    CYL : (-)

(R) S	C	A
-0.25	-0.75	88
-0.25	-0.75	90
-0.25	-0.75	90
-0.25	-0.75	90
-0.25	-0.75	90
<b>-0.25</b>	<b>-0.75</b>	<b>90</b>
S.E.	-0.75	

Typical value of right eye

(L) S	C	A
( +0.25	-0.75	88 )
+0.25	**	**
7 +0.25	-0.75	90
1 +0.25	-0.75	90
4 +0.25	-0.75	90
<b>-0.25</b>	<b>-0.75</b>	<b>90</b>
S.E.	-0.75	

Typical value of left eye

PD : 65 ADD : 2.25 NPD : 61  
TOPCON

Reliability mark  
(displayed when reliability is low)

<KRT> mode



-KR 010602-

NAME

2003\_03\_01 AM 10:00  
No. 0001 01

KRT.DATA

(R) D	MM	A
H	45.00	7.50 32
V	44.75	7.53 122
AVE	44.87	7.52
CYL	-0.25	122
CORNEA DIA	: 12.00	
MM1	MM2	A1
■1	7.50	7.53 122
■2	7.50	7.53 122
■3	7.50	7.53 122
■4	7.50	7.53 122
■5	7.50	7.53 122

Typical measured value of right eye corneal curvature

Measured value of right eye cornea (mm)

Results of 5 right eye corneal curvature measurements of right eye, average value and astigmatic power of cornea (recordable up to 10 measurements each for right / left eye)

(L) D	MM	A
H	45.00	7.50 32
V	44.75	7.53 122
AVE	44.87	7.52
CYL	-0.25	122
CORNEA DIA	: 12.00	
MM1	MM2	A1
■1	7.50	7.53 122
■2	7.50	7.53 122
■3	7.50	7.53 122
■4	7.50	7.53 122
■5	7.50	7.53 122

Measured value of left eye

TOPCON



<R/K><KRT> mode

The kerato data display in the case of setting the HV display as the R1R2 display.

KRT.DATA			
(R)	D	MM	A
R1	44.75	7.53	122
R2	45.00	7.50	32
AVE	44.87	7.52	

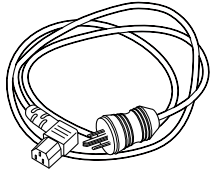
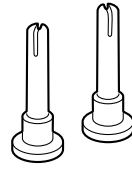
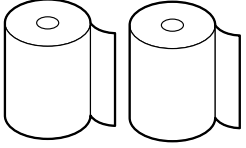
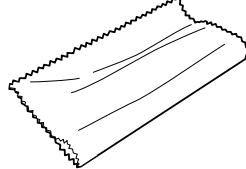
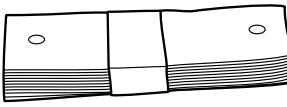

## STANDARD ACCESSORIES

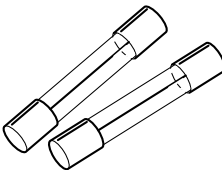
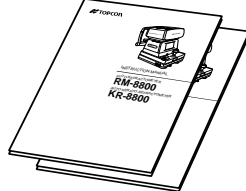
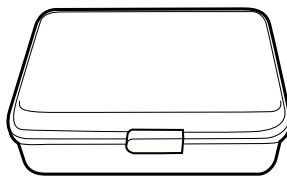
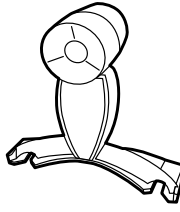
The following are standard accessories. Make sure that all these items are included (quantity).

<p>Power cable (1)</p> 	<p>Chinrest pin (2)</p> 
<p>Printer paper (2)</p> 	<p>Silicon cloth (1)</p> 
<p>Chinrest tissue (1)</p> 	<p>Dust cover (1)</p> 
<p>Fuse (2)</p> 	<p>Instruction manuals: unpacking and assembling (1 each)</p> 
<p>Accessory box (1)</p> 	<p>Model eye (1)</p> 

# PREPARATIONS

## INSTALLATION

 <b>CAUTION</b>	Before moving the instrument, fasten the clamping knob at the bottom surface to stop movements. Negligence of this may cause injury by falling parts.
 <b>CAUTION</b>	When moving the instrument, be sure to hold it at the bottom surface with two persons. Carrying by one person may cause a backache or injury by falling parts. Also, holding area other than the bottom surface may cause pinching fingers between parts and injury by falling parts as well as damage to the instrument.
 <b>CAUTION</b>	To prevent injury due to tumbling of the instrument body and falling parts, avoid a slope and unstable floor for installation.

- 1** Fasten the clamping knob.
- 2** Firmly hold the instrument at the specified position and place it on the automatic instrument table.  
For the automatic instrument table, see “OPTIONAL ACCESSORIES” on page 80.

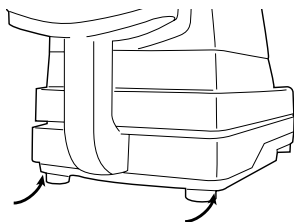

Holding positions

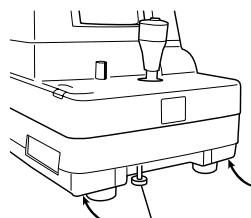

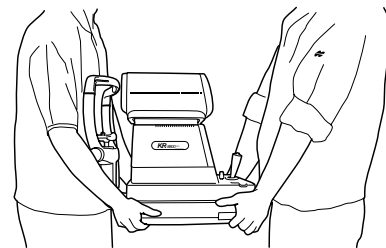

Clamping knob



Holding the instrument

- 3** After installation, loosen the clamping knob.  
Now the main body can be moved.

## CONNECTING POWER CABLE

 <b>WARNING</b>	Be sure to connect the power plug to an AC 3-pin receptacle equipped with grounding. Connection with receptacle without grounding may cause fire and electric shock in case of short-circuiting.
 <b>CAUTION</b>	To avoid electric shocks, do not handle the power plug with wet fingers.

- 1** Make sure that the power switch of the main body is off.
- 2** Plug the power cable to the main body.

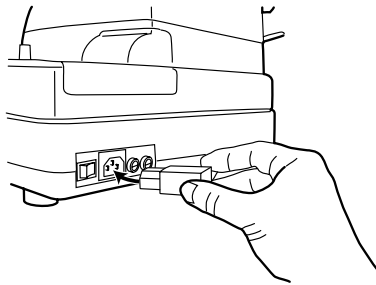

- 3** Plug the power cable to a grounded 3-pin AC receptacle.

## CONNECTING EXTERNAL I/O TERMINALS

### **RS232C OUT**

This machine may be connected with a PC (personal computer) using RS232C .

- 1** Connect the connection cable to the OUT terminal of the main body.
- 2** Connect the other end of the connection cable to the PC.

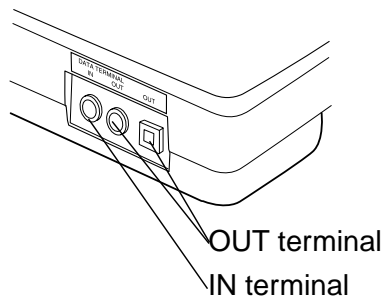

### **RS232C IN**

Also, this machine may be connected with a bar code reader using RS232C.

- 1** Connect the connection cable to the IN terminal of the main body.
- 2** Connect the other end of the connection cable to the external device.

## INITIAL SETTINGS

In the initial setting, settings such as patient No., instrument No., refractory power shift, ON LINE, auto print, etc. can be done.

### PREPARATION FOR INITIAL SETTING

- 1** Make sure of the connection of power cable.  
For connection, see "CONNECTING POWER CABLE" on page 20.
- 2** While pressing **MENU SWITCH** of the control panel, press on the **POWER SWITCH**.  
Hold the **MENU SWITCH** till the buzzer sounds. The POWER lamp lights and the initial menu screen is displayed.

### RETURNING TO THE MEASUREMENT SCREEN

- 1** Press the **MEASUREMENT SWITCH** switch and move the cursor to "EXIT".
- 2** Press the **PRINT SWITCH**. (EXIT OK is displayed.)
- 3** Press the **PRINT SWITCH** again. (The measurement screen is returned and the set items are printed out.)

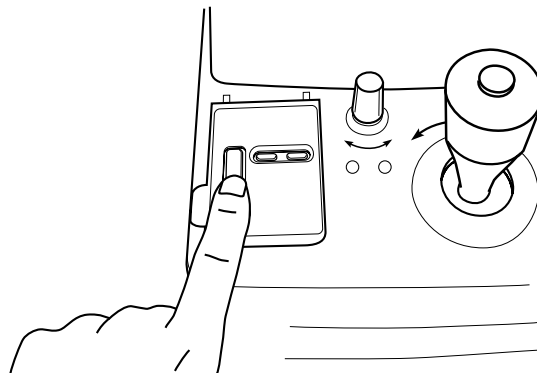
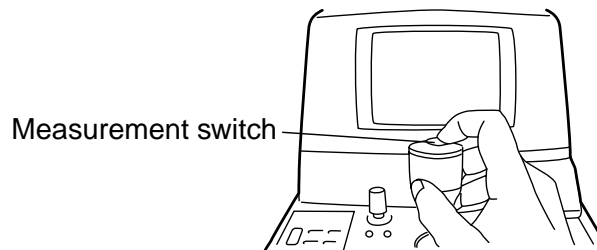
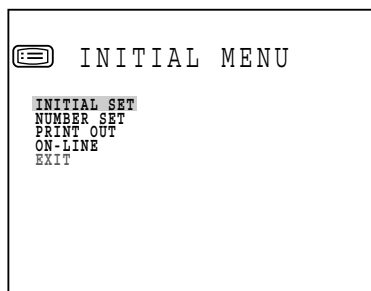

## INITIAL SET SCREEN

In the INITIAL SET screen, buzzer sound, refractory power shift, display of typical value in monitor screen and date can be changed.

- 1 In the "INITIAL MENU SCREEN", make sure that the cursor is on "INITIAL SET", and then press the **PRINT SWITCH**. The monitor screen is changed to the INITIAL SET SCREEN.

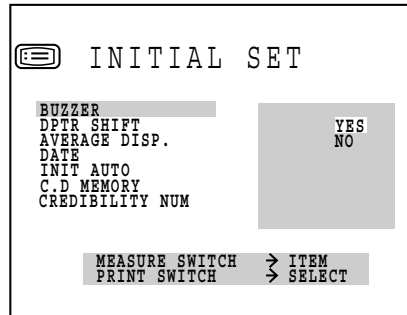

- Close the "INITIAL SET SCREEN" and call the "INITIAL MENU SCREEN".
- Move the cursor to "EXIT".
- Press the **PRINT SWITCH**.



To return to the previous item in the screen:  
While pressing the **PRINT SWITCH**, press the **MEASUREMENT SWITCH**.

## BUZZER SOUND SETTING

The buzzer sound can be set. Before shipment, it is set to (YES) so that the buzzer sounds.

- 1 In the "INITIAL MENU SCREEN", choose "INITIAL SET" and get the "INITIAL SET SCREEN".

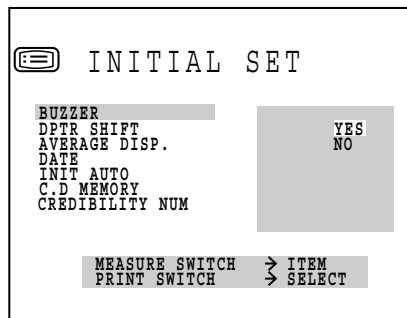

- 2 Press the **PRINT SWITCH**, and choose "YES" (buzzer sound) or "NO" (no buzzer sound) of "BUZZER".
- 3 Setting is done by pressing the **MEASUREMENT SWITCH**, and the cursor goes to the next item.



## SHIFTING REFRACTORY POWER

The refractory power (S value) can be shifted.

- 1 In the "INITIAL MENU SCREEN", choose "INITIAL SET" and get the "INITIAL SET" screen.

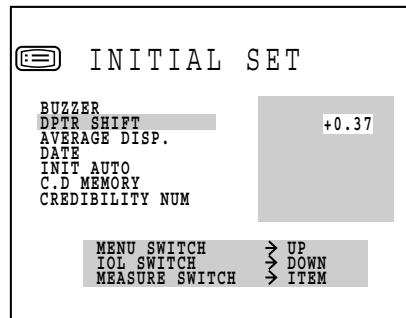

- 2 Press the **MEASUREMENT SWITCH** and move the cursor to "DPTR SHIFT".
- 3 Pressing the **MENU SWITCH** increases the value.  
Pressing the **IOL SWITCH** decreases the value.  
Values can be set at 0.12D steps between -1.00D and +1.00D.
- 4 Press the **MEASUREMENT SWITCH**, and the cursor goes to the next item.

## MONITOR SCREEN DISPLAY OF TYPICAL VALUE

The typical value can be displayed in the monitor screen. Before shipment, it is set to "NO" (no display).

- 1 In the "INITIAL MENU SCREEN", choose "INITIAL SET" and get the "INITIAL SET SCREEN".

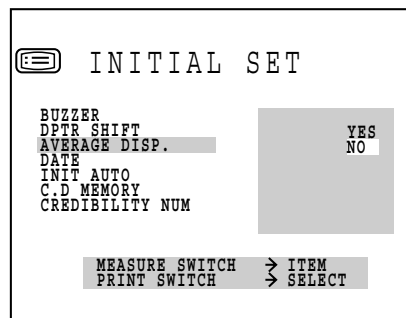

- 2 Press the **MEASUREMENT SWITCH** and move the cursor to "AVERAGE DISP".
- 3 Press the **PRINT SWITCH** and choose "YES" (display in measuring screen) or "NO" (no display in measuring screen).
- 4 Press the **MEASUREMENT SWITCH**, and the cursor goes to the next item.



For "YES" setting, set "DISPLAY STYLE" to "LAYOUT 2".

To set "DISPLAY STYLE" to "LAYOUT 2", see "CHANGE DISPLAY STYLE" on page 26.

## CHANGING DATE DISPLAY

The date format of printout can be changed. Before shipment, it is set to "2003.12.01".

- 1 In the "INITIAL MENU SCREEN", choose "INITIAL SET" and get the "INITIAL SET SCREEN".

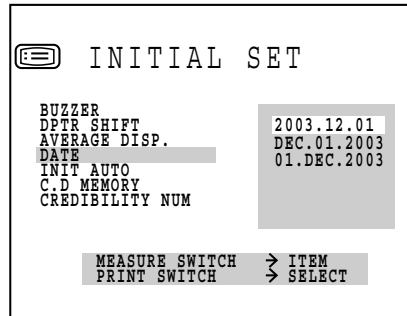

- 2 Press the **MEASUREMENT SWITCH** and move the cursor to "DATE".
- 3 Press the **PRINT SWITCH** and choose:  
2003.12.01,  
DEC. 01. 2003, or  
01. DEC. 2003.
- 4 Press the **MEASUREMENT SWITCH**, and the cursor moves to the next item.

## START MODE AFTER POWER ON (Only in KR-8800)

The start mode can be set. Before shipment, it is set to "YES" (Auto start mode).

- 1 In the "INITIAL MENU SCREEN", choose "INITIAL SET" and get the "INITIAL SET SCREEN".
- 2 Press the **MEASUREMENT SWITCH** and move the cursor to "INIT AUTO".

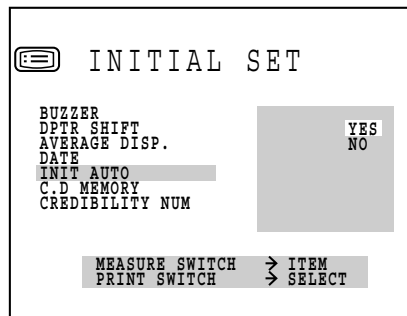

- 3 Press the **PRINT SWITCH** and choose "YES" (Auto start ) or "NO" (Manual start ).
- 4 Press the **MEASUREMENT SWITCH** ,and the cursor moves to the next item.

## CHANGING THE CORNEA DIAMETER MEASUREMENT METHOD (Only in KR-8800)

The method of cornea diameter measurement can be chosen between the measurement using the actual image or the static image. Before shipment, the setting is NO (measurement using actual image).

- 1 Press the **MEASUREMENT SWITCH** and bring the cursor to C.D MEMORY.

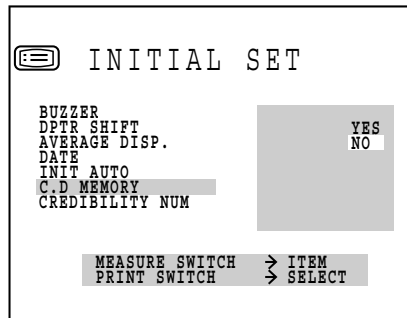

- 2 Press the **PRINT SWITCH** and choose "YES" (measurement using static image) or "NO" (measurement using actual image).
- 3 Press the **MEASUREMENT SWITCH**, and the cursor moves to the next item.

## RELIABILITY FACTOR

The reliability factor can be printed out. Before shipment, it is set to [NO] (no printout).

- 1 In the "INITIAL MENU SCREEN", choose "INITIAL SET" and get the "INITIAL SET SCREEN".

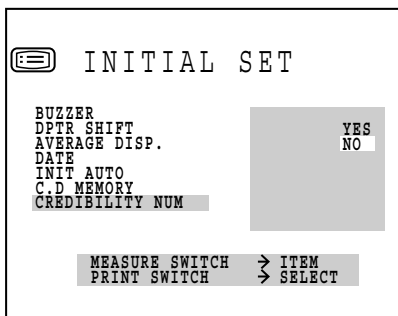

- 2 Press the **MEASUREMENT SWITCH** and move the cursor to "CREDIBILITY NUM".
- 3 Press the **PRINT SWITCH** and choose "YES" (printout) or "NO" (no printout).
- 4 Press the **MEASUREMENT SWITCH**, and the cursor moves to the next item.

## ADD FACTOR

The ordinary additional power (ADD) can be printed out. Before shipment, it is set to [NO] (no printout).

- 1 In the "INITIAL MENU SCREEN", choose "INITIAL SET" and get the "INITIAL SET SCREEN".

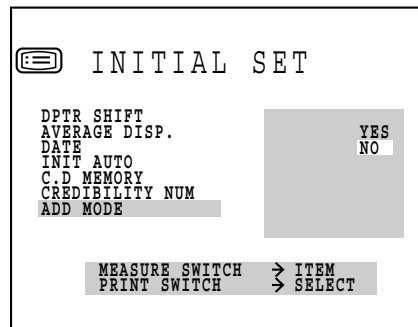

- 2 Press the **MEASUREMENT SWITCH** and move the cursor to "ADD MODE".
- 3 Press the **PRINT SWITCH** and choose "YES" (printout) or "NO" (no printout).
- 4 Press the **MEASUREMENT SWITCH**, and the cursor moves to the next item.

## CHANGING DISPLAY STYLE

The display style can be changed. Before shipment, it is set to "LAYOUT 1".

- 1 In the "INITIAL MENU SCREEN", choose "INITIAL SET" and get the "INITIAL SET SCREEN".

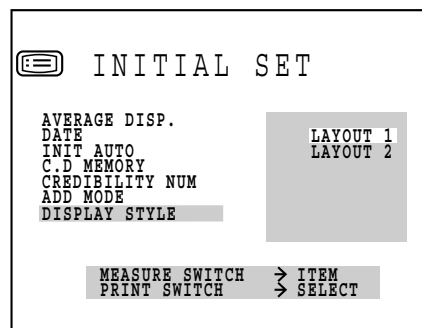

- 2 Press the **MEASUREMENT SWITCH** and move the cursor to "DISPLAY STYLE".
- 3 Press the **PRINT SWITCH** and choose "LAYOUT 1" or "LAYOUT 2".
- 4 Press the **MEASUREMENT SWITCH**, and the cursor moves to the next item.
- 5 Press the **MEASUREMENT SWITCH**, and the cursor returns to the first item (BUZZER).

## NO. SETTING

In the “NUMBER SET” screen, patient No. setting, monitor screen display of patient No., printing patient No., resetting of patient No., instrument No. setting, monitor screen display of instrument No. and printing instrument No. can be changed.

- 1** In the “INITIAL MENU SCREEN”, press the **MEASUREMENT SWITCH** and move the cursor to “NUMBER SET”.
- 2** Press the **PRINT SWITCH**, and the monitor screen is changed to the “NUMBER SET SCREEN”.

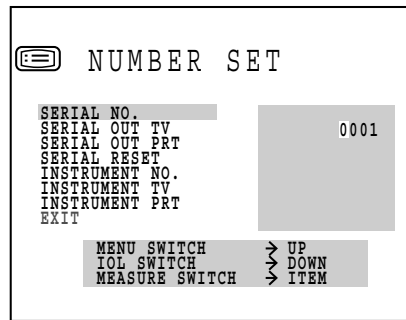

- Close the “NUMBER SET SCREEN” and call the “INITIAL MENU SCREEN”.
- Move the cursor to “EXIT”.
- Press the **PRINT SWITCH**.



- To return to the previous item in the screen:
- While pressing the **PRINT SWITCH**, press the **MEASUREMENT SWITCH**.

## **SETTING PATIENT NO.**

The patient No. can be set between 0 and 9999. Before shipment, it is set to “0001”.

- 1** In the “INITIAL MENU SCREEN”, choose “NUMBER SET” and get the “NUMBER SET SCREEN”.

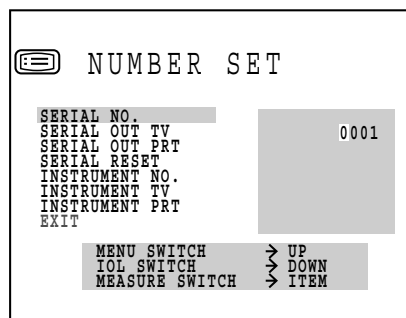

- 2** Press the **MEASUREMENT SWITCH** and move the cursor to “SERIAL NO”.
- 3** Pressing the **MENU SWITCH** increases the value.  
Pressing the **IOL SWITCH** decreases the value.
- 4** Press the **MEASUREMENT SWITCH**, and the cursor moves to the next item.

## MONITOR SCREEN DISPLAY OF PATIENT NO.

The patient No. can be displayed in the monitor screen. Before shipment, it is set to (YES).

- 1 In the "INITIAL MENU SCREEN", choose "NUMBER SET" and get the "NUMBER SET SCREEN".

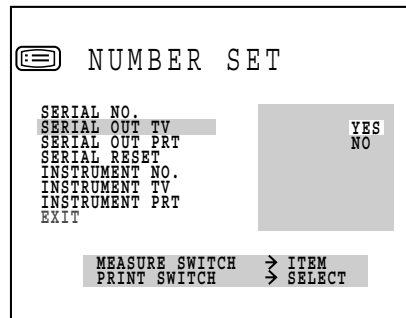

- 2 Press the **MEASUREMENT SWITCH** and move the cursor to "SERIAL OUT TV".
- 3 Press the **PRINT SWITCH** and choose "YES" (display in measuring screen) or "NO" (no display in measuring screen).
- 4 Press the **MEASUREMENT SWITCH** , and the cursor moves to the next item.

## PRINTING PATIENT NO.

The patient No. can be printed out. Before shipment, it is set to [YES] (printout).

- 1 In the "INITIAL MENU SCREEN", choose "NUMBER SET" and get the "NUMBER SET SCREEN".

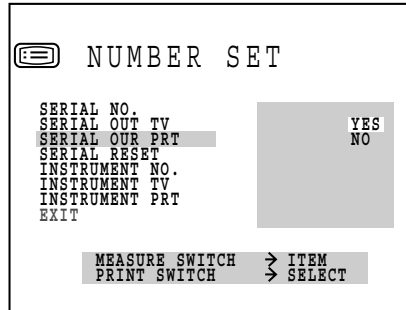

- 2 Press the **MEASUREMENT SWITCH** and move the cursor to "SERIAL OUT PRT".
- 3 Press the **PRINT SWITCH** and choose "YES" (printout) or "NO" (no printout).
- 4 Press the **MEASUREMENT SWITCH** , and the cursor moves to the next item.

## RESETTING PATIENT NO.

The patient No. can be reset by switching on the power source. Before shipment, it is set to "NO" (no reset).

- 1 In the "INITIAL MENU SCREEN", choose "NUMBER SET" and get the "NUMBER SET SCREEN".

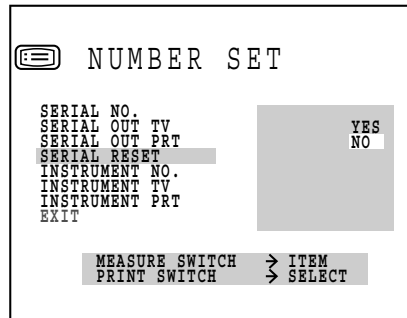

- 2 Press the **MEASUREMENT SWITCH** and move the cursor to "SERIAL RESET".
- 3 Press the **PRINT SWITCH** and choose "YES" (rest) or "NO" (no reset).
- 4 Press the **MEASUREMENT SWITCH** , and the cursor moves to the next item.

## SETTING INSTRUMENT NO.

The instrument No. can be set between 0 and 99. Before shipment, it is set to "01".

- 1 In the "INITIAL MENU SCREEN", choose "NUMBER SET" and get the "NUMBER SET SCREEN".

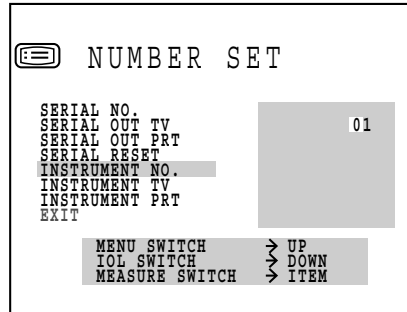

- 2 Press the **MEASUREMENT SWITCH** and move the cursor to "INSTRUMENT NO.".
- 3 Pressing the **MENU SWITCH** increases the value.  
Pressing the **IOL SWITCH** decreases the value.
- 4 Press the **MEASUREMENT SWITCH** , and the cursor moves to the next item.

## MONITOR SCREEN DISPLAY OF INSTRUMENT NO.

The instrument No. can be displayed in the monitor screen. Before shipment, it is set to “NO” (no display).

- 1 In the “INITIAL MENU SCREEN”, choose “NUMBER SET” and get the “NUMBER SET SCREEN”.

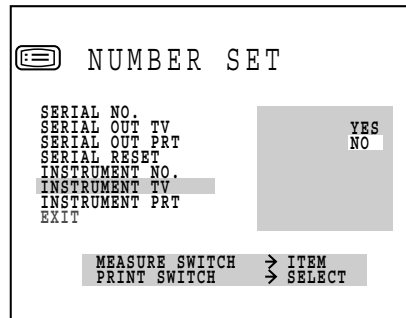

- 2 Press the **MEASUREMENT SWITCH** and move the cursor to “INSTRUMENT TV”.
- 3 Press the **PRINT SWITCH** and choose “YES” (display in measuring screen) or “NO” (no display in measuring screen).
- 4 Press the **MEASUREMENT SWITCH** , and the cursor moves to the next item.

## PRINTING INSTRUMENT NO.

The instrument No. can be printed out. Before shipment, it is set to (NO) [no printout].

- 1 In the “INITIAL MENU SCREEN”, choose “NUMBER SET” and get the “NUMBER SET SCREEN”.

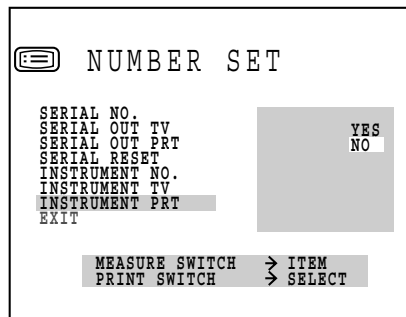

- 2 Press the **MEASUREMENT SWITCH** and move the cursor to “INSTRUMENT PRT”.
- 3 Press the **PRINT SWITCH** and choose “YES” (printout) or “NO” (no printout).
- 4 Press the **MEASUREMENT SWITCH** , and the cursor moves to the next item.



## PRINTOUT

In the "PRINT OUT" screen, printout format, printing equivalent spherical power, printing computer lensmeter data, and printing bar code can be changed.

- 1 In the "INITIAL MENU SCREEN", press the **MEASUREMENT SWITCH** and move the cursor to "PRINT OUT".
- 2 Press the **PRINT SWITCH**, and the monitor screen is changed to the "PRINT OUT SCREEN".

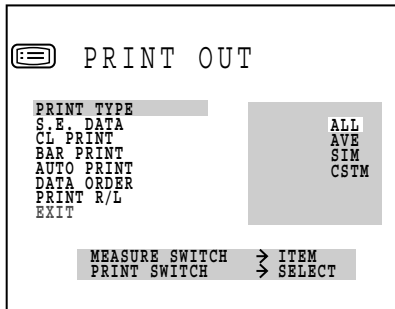

- Close the "PRINT OUT SCREEN" and call the "INITIAL MENU SCREEN".
- Move the cursor to "EXIT".
- Press the **PRINT SWITCH**.



To return to the previous item in the screen:  
While pressing the **PRINT SWITCH**, press the **MEASUREMENT SWITCH**.

## PRINTOUT FORMAT

The printout format can be set. Before shipment, it is set to "ALL" (print out all data).

- 1 In the "INITIAL MENU SCREEN", choose "PRINT OUT" and get the "PRINT OUT SCREEN".

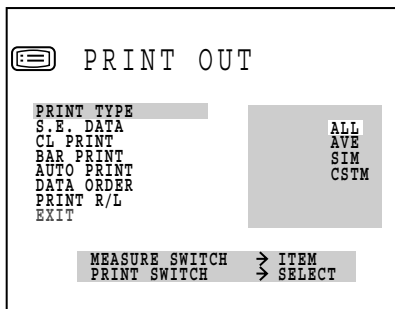

- 2 Press the **MEASUREMENT SWITCH** and move the cursor to "PRINT TYPE".
- 3 Press the **PRINT SWITCH** and choose:
  - ALL (print out all data);
  - AVE (print out date, settings and typical value of refractory power only);
  - SIM (print out typical value only); or
  - CSTM (select the settings by each item). → page 35 } page 32
- 4 Press the **MEASUREMENT SWITCH**, and the cursor moves to the next item.

## PRINTING EQUIVALENT SPHERICAL POWER

The equivalent spherical power can be printed. Before shipment, it is set to “YES” (printout).

- 1 In the “INITIAL MENU SCREEN”, choose “PRINT OUT” and get the “PRINT OUT SCREEN”.

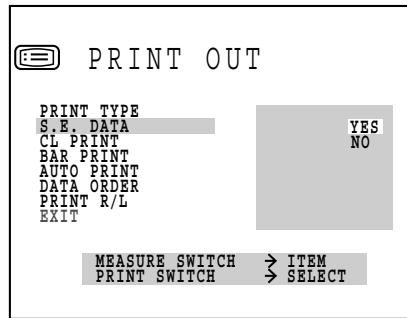

- 2 Press the **MEASUREMENT SWITCH** and move the cursor to “S.E.DATA”.
- 3 Press the **PRINT SWITCH** and choose “YES” (printout) or “NO” (no printout).
- 4 Press the **MEASUREMENT SWITCH**, and the cursor moves to the next item.

## PRINTING COMPUTER LENSMETER DATA

Computer lensmeter data can be printed. Before shipment, it is set to “NO” (no printout).

- 1 In the “INITIAL MENU SCREEN”, choose “PRINT OUT” and get the “PRINT OUT SCREEN”.

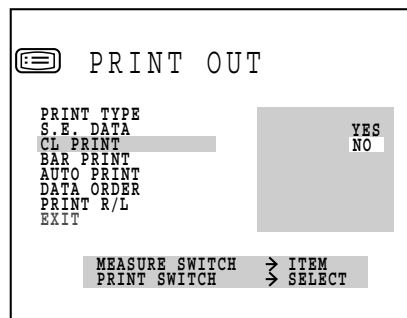

- 2 Press the **MEASUREMENT SWITCH** and move the cursor to “CL PRINT”.
- 3 Press the **PRINT SWITCH** and choose “YES” (printout) or “NO” (no printout).
- 4 Press the **MEASUREMENT SWITCH**, and the cursor moves to the next item.

## PRINTING BAR CODE

The bar code can be printed out. Before shipment, it is set to "NO" (no printout).

- 1 In the "INITIAL MENU SCREEN", choose "PRINT OUT" and get the "PRINT OUT SCREEN".

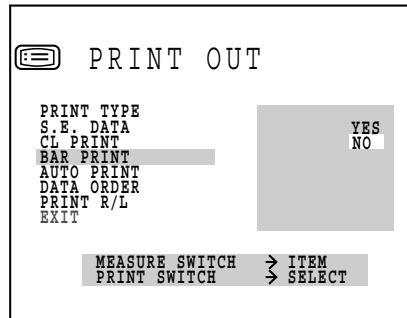

- 2 Press the **MEASUREMENT SWITCH** and move the cursor to "BAR PRINT".
- 3 Press the **PRINT SWITCH** and choose "YES" (printout) or "NO" (no printout).
- 4 Press the **MEASUREMENT SWITCH**, and the cursor moves to the next item.

## AUTO PRINT AFTER FINISHING AUTO START MEASUREMENT (Only in KR-8800)

- 1 Press the **MEASUREMENT SWITCH** and bring the cursor to "AUTO PRINT".

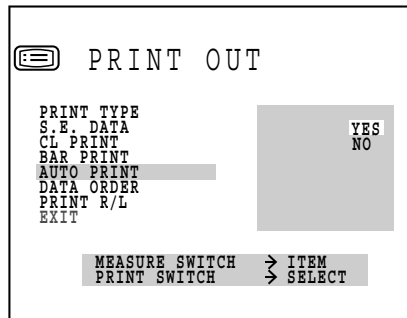

- 2 Press the **PRINT SWITCH** and choose "YES" (auto printout) or "NO" (no auto printout).
- 3 Press the **MEASUREMENT SWITCH**, and the cursor moves to the next item.

## CHANGING THE PRINTOUT DISPLAY ORDER (Only in KR-8800)

- 1 Press the **MEASUREMENT SWITCH** and bring the cursor to "DATA ORDER".  
The printout display order of cornea refractory power and curvature can be changed.  
Before shipment, the setting is "D/MM".

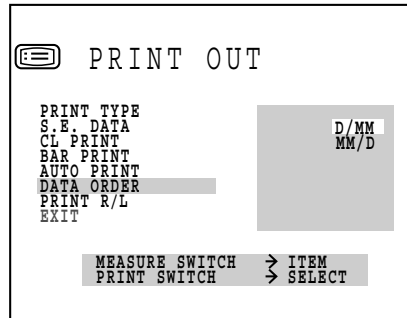

- 2 Press the **PRINT SWITCH** and choose D/MM or MM/D.
- 3 Press the **MEASUREMENT SWITCH**, and the cursor moves to the next item.

## CHANGING THE PRINTOUT DISPLAY ORDER (Only in KR-8800)

- 1 Press the **MEASUREMENT SWITCH** and bring the cursor to "PRINT R/L".

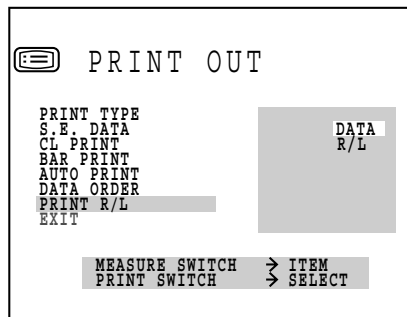

- 2 Press the **PRINT SWITCH** and choose  
DATA (separate printout for REF/KRT), or  
R/L (printout of right eye and left eye in this order, irrespective of REF/KRT)
- 3 Press the **MEASUREMENT SWITCH**, and the cursor moves to the next item.

## CUSTOM-PRINT SETTINGS

This machine provides the ability to select the items to be printed, called the custom print function. On the custom-print screen, the details of the following items can be changed individually: refraction measurement values, cornea measurement values, corneal astigmatism and axial angles, PD values, the name, date, VD values, cylindricity mark and the TOPCON mark On/Off.

**1** On the “PRINT OUT SCREEN”, press the **MENU SWITCH** and move the cursor to “PRINT TYPE”.

**2** Press the **PRINT SWITCH**, select “CSTM” and press the **IOL SWITCH**.

The monitor screen changes to the “CSTM PRINT SCREEN”.

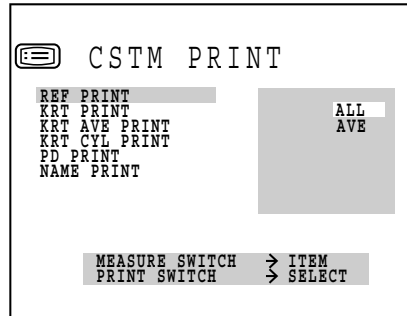

To exit this screen



- Move the cursor to “EXIT”, then press the **PRINT SWITCH**.  
Close the “CSTM PRINT SCREEN” and call the “PRINT OUT SCREEN”.
- Move the cursor to “EXIT”.
- Press the **PRINT SWITCH**.



Return to the previous item in the screen

- Hold the **PRINT SWITCH** down and press the **MEASUREMENT SWITCH**.

## CHANGING THE PRINT TYPE OF REFRACTION MEASUREMENT VALUES

The print type of refraction measurement values may be changed. Before shipment it is set to "ALL" (print all data).

- 1 On the "PRINT OUT SCREEN", move the cursor to "PRINT TYPE", and with "CSTM" selected, press the **(IOL SWITCH)** and get the "CSTM PRINT SCREEN".

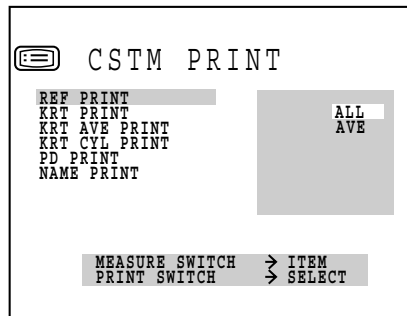

- 2 Press the **(MEASUREMENT SWITCH)** and move the cursor to "REF PRINT".
- 3 Press the **(PRINT SWITCH)** and select ALL (Print all data), or AVE (Print typical values only)
- 4 Press the **(MEASUREMENT SWITCH)**, and the cursor moves to the next item.

## CHANGING THE PRINT TYPE OF CORNEA MEASUREMENT VALUES (Only in KR-8800)

The print type of cornea measurement values may be changed. Before shipment it is set to "AVE" (print typical values only).

- 1 On the "PRINT OUT SCREEN", move the cursor to "PRINT TYPE", and with "CSTM" selected, press the **(IOL SWITCH)** and get the "CSTM PRINT SCREEN".

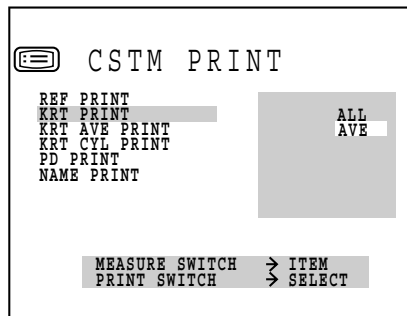

- 2 Press the **(MEASUREMENT SWITCH)** and move the cursor to "KRT PRINT".
- 3 Press the **(PRINT SWITCH)** and select ALL (Print all data), or AVE (Print typical values only)
- 4 Press the **(MEASUREMENT SWITCH)**, and the cursor moves to the next item.

## PRINTING AVERAGE VALUES OF CORNEA MEASUREMENTS (Only in KR-8800)

Average values of cornea measurements may be printed out. Before shipment it is set to "YES" (print average values).

- 1 On the "PRINT OUT SCREEN", move the cursor to "PRINT TYPE", and with "CSTM" selected, press the **(IOL SWITCH)** and get the "CSTM PRINT SCREEN".

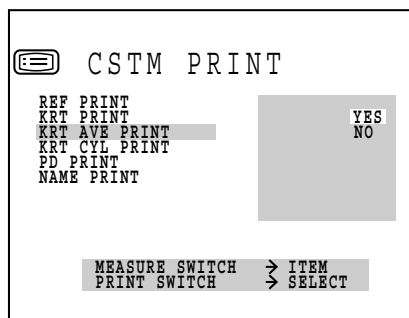

- 2 Press the **(MEASUREMENT SWITCH)** and move the cursor to "KRT AVE PRINT".
- 3 Press the **(PRINT SWITCH)** and select "YES" (print average values), or "NO" (do not print average values).
- 4 Press the **(MEASUREMENT SWITCH)** , and the cursor moves to the next item.

## PRINTING CORNEAL ASTIGMATISM AND AXIAL ANGLES (Only in KR-8800)

Corneal astigmatism and axial angles may be printed out. Before shipment it is set to "YES" (print corneal astigmatism and axial angles).

- 1 On the "PRINT OUT SCREEN", move the cursor to "PRINT TYPE", and with "CSTM" selected, press the **(IOL SWITCH)** and get the "CSTM PRINT SCREEN".

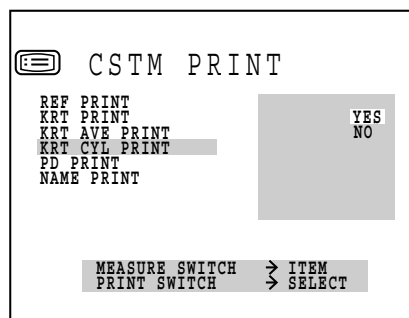

- 2 Press the **(MEASUREMENT SWITCH)** and move the cursor to "KRT CYL PRINT".
- 3 Press the **(PRINT SWITCH)** and select "YES" (print corneal astigmatism and axial angles), or "NO" (do not print corneal astigmatism and axial angles).
- 4 Press the **(MEASUREMENT SWITCH)** , and the cursor moves to the next item.

## PRINTING PD VALUES

PD values may be printed out. Before shipment it is set to “YES” (print PD values).

- 1 On the “PRINT OUT SCREEN”, move the cursor to “PRINT TYPE”, and with “CSTM” selected, press the **(IOL SWITCH)** and get the “CSTM PRINT SCREEN”.

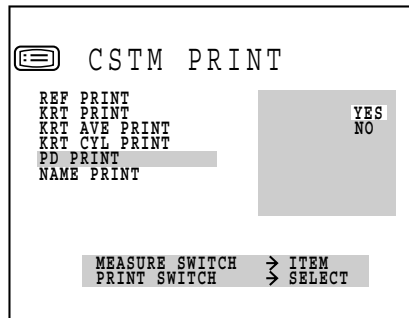

- 2 Press the **(MEASUREMENT SWITCH)** and move the cursor to “PD PRINT”.
- 3 Press the **(PRINT SWITCH)** and select “YES” (print PD values), or “NO” (do not print PD values).
- 4 Press the **(MEASUREMENT SWITCH)** , and the cursor moves to the next item.

## PRINTING NAMES

The name may be printed out. Before shipment it is set to “YES” (print names).

- 1 On the “PRINT OUT SCREEN”, move the cursor to “PRINT TYPE”, and with “CSTM” selected, press the **(IOL SWITCH)** and get the “CSTM PRINT SCREEN”.

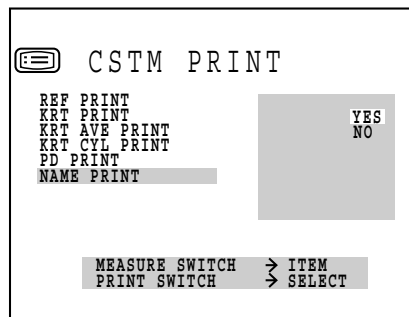

- 2 Press the **(MEASUREMENT SWITCH)** and move the cursor to “NAME PRINT”.
- 3 Press the **(PRINT SWITCH)** and select “YES” (print names), or “NO” (do not print names).
- 4 Press the **(MEASUREMENT SWITCH)** , and the cursor moves to the next item.



## PRINTING THE DATE

The date may be printed out. Before shipment it is set to “YES” (print date).

- 1 On the “PRINT OUT SCREEN”, move the cursor to “PRINT TYPE”, and with “CSTM” selected, press the **(IOL SWITCH)** and get the “CSTM PRINT SCREEN”.

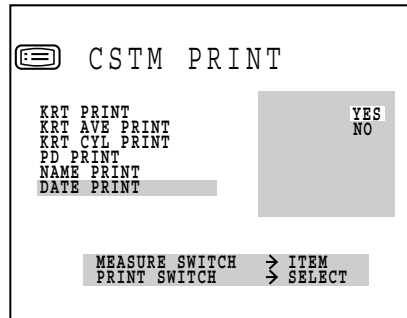

- 2 Press the **(MEASUREMENT SWITCH)** and move the cursor to “DATE PRINT”.
- 3 Press the **(PRINT SWITCH)** and select “YES” (print date), or “NO” (do not print date).
- 4 Press the **(MEASUREMENT SWITCH)** , and the cursor moves to the next item.

## PRINTING VD VALUES

VD values may be printed out. Before shipment it is set to “YES” (print VD values).

- 1 On the “PRINT OUT SCREEN”, move the cursor to “PRINT TYPE”, and with “CSTM” selected, press the **(IOL SWITCH)** and get the “CSTM PRINT SCREEN”.

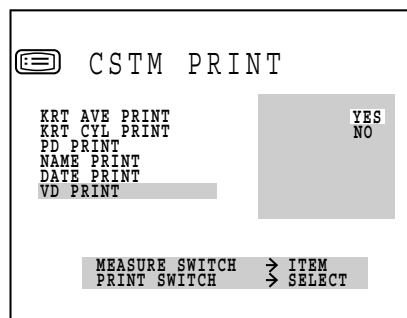

- 2 Press the **(MEASUREMENT SWITCH)** and move the cursor to “VD PRINT”.
- 3 Press the **(PRINT SWITCH)** and select “YES” (print VD values), or “NO” (do not print VD values).
- 4 Press the **(MEASUREMENT SWITCH)** , and the cursor moves to the next item.

## PRINTING THE CYLINDRICITY MARK

The cylindricity mark may be printed out. Before shipment it is set to “YES” (print cylindricity mark).

- 1 On the “PRINT OUT SCREEN”, move the cursor to “PRINT TYPE”, and with “CSTM” selected, press the **(IOL SWITCH)** and get the “CSTM PRINT SCREEN”.

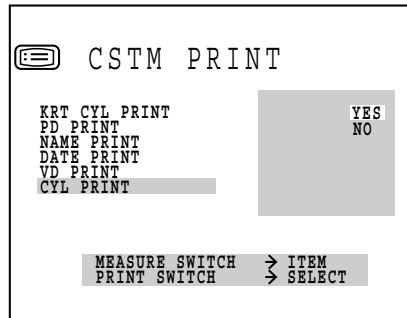

- 2 Press the **(MEASUREMENT SWITCH)** and move the cursor to “CYL PRINT”.
- 3 Press the **(PRINT SWITCH)** and select “YES” (print cylindricity mark), or “NO” (do not print cylindricity mark).
- 4 Press the **(MEASUREMENT SWITCH)** , and the cursor moves to the next item.

## PRINTING THE TOPCON MARK

The TOPCON mark may be printed out. Before shipment it is set to “YES” (print TOPCON mark).

- 1 On the “PRINT OUT SCREEN”, move the cursor to “PRINT TYPE”, and with “CSTM” selected, press the **(IOL SWITCH)** and get the “CSTM PRINT SCREEN”.

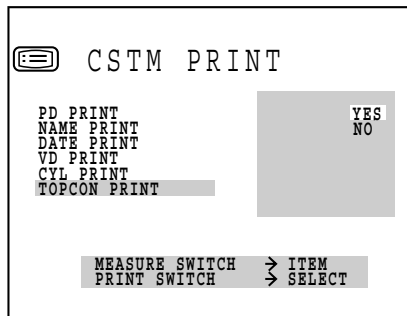

- 2 Press the **(MEASUREMENT SWITCH)** and move the cursor to “TOPCON PRINT”.
- 3 Press the **(PRINT SWITCH)** and select “YES” (print TOPCON mark), or “NO” (do not print TOPCON mark).
- 4 Press the **(MEASUREMENT SWITCH)** , and the cursor moves to the next item.

## ON-LINE (DATA COMMUNICATION)

In the "ON-LINE" screen, computer lensmeter data receiving format, communication format and communication speed can be changed.

- 1 In the "INITIAL MENU SCREEN", press the **(MEASUREMENT SWITCH)** and move the cursor to "ON-LINE".
- 2 Press the **(PRINT SWITCH)**, and the monitor screen is changed to the "ON-LINE SCREEN".

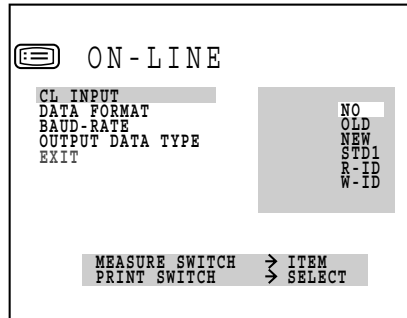

- Close the "ON-LINE SCREEN" and call the "INITIAL MENU SCREEN".
- Move the cursor to "EXIT".
- Press the **(PRINT SWITCH)**.



- To return to the previous item in the screen:
- While pressing the **(PRINT SWITCH)**, press the **(MEASUREMENT SWITCH)**.

## COMPUTER LENSMETER DATA RECEIVING FORMAT

The RS232C format for receiving computer lensmeter data can be set. Before shipment, it is set to "NO" (no receiving).

- 1 In the "INITIAL MENU SCREEN", choose "ON-LINE" and get the "ON-LINE SCREEN".

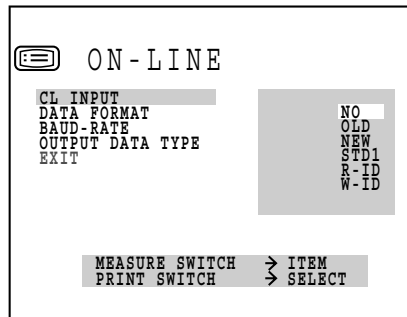

- 2** Press the **MEASUREMENT SWITCH** and move the cursor to “CL INPUT”.
- 3** Press the **PRINT SWITCH** and choose:
  - NO (no receiving),
  - OLD (OLD RS232C format),
  - NEW (NEW RS232C format),
  - STD1 (STD1 RS232C format),
  - R-ID (receives patient No. via RS232C input port for processing as real ID), or
  - W-ID (receives patient No. via RS232C input port for processing as work ID).
- 4** Press the **MEASUREMENT SWITCH** , and the cursor moves to the next item.

## SETTING COMMUNICATION FORMAT

The communication format can be set. Before shipment, it is set to “OLD” (old TOPCON format).

- 1** In the “INITIAL MENU SCREEN”, choose “ON-LINE” and get the “ON-LINE SCREEN”.

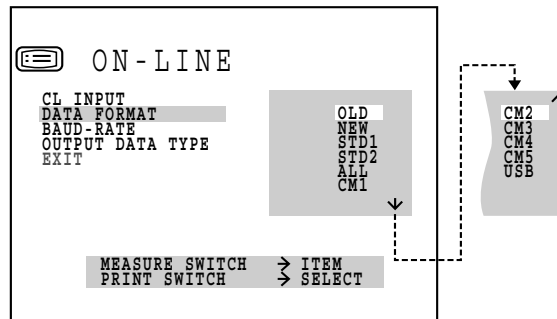

- 2** Press the **MEASUREMENT SWITCH** and move the cursor to “DATA FORMAT”.
- 3** Press the **PRINT SWITCH** and choose:
  - OLD (OLD Topcon format),
  - NEW (NEW Topcon format),
  - STD1 (TOPCON STD1 format),
  - STD2 (TOPCON STD2 format),
  - ALL (tool mode),
  - CM1 (custom specification),
  - CM2 (custom specification),
  - CM3 (custom specification),
  - CM4 (custom specification), or
  - CM5 (custom specification).
- 4** Press the **MEASUREMENT SWITCH** , and the cursor moves to the next item.

## SETTING RS232C COMMUNICATION SPEED

The RS232C communication speed can be set. Before shipment, it is set to “2400” (baud rate 2400).

- 1 In the “INITIAL MENU SCREEN”, choose “ON-LINE” and get the “ON-LINE SCREEN”.

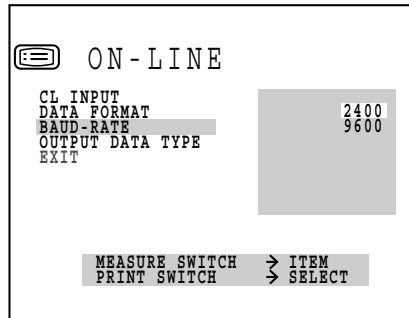

- 2 Press the **MEASUREMENT SWITCH** and move the cursor to “BAUD-RATE”.
- 3 Press the **PRINT SWITCH** and choose:  
2400 (baud rate 2400), or  
9600 (baud rate 9600).
- 4 Press the **MEASUREMENT SWITCH**, and the cursor moves to the next item.



For inquiries about the RS232C communication format, please contact your dealer or Topcon at the address stated on the back cover.

## SELECTING RS232C OUTPUT DATA (Only in KR-8800)

- 1 Press the **MEASUREMENT SWITCH** and bring the cursor to “OUTPUT DATA TYPE”s.

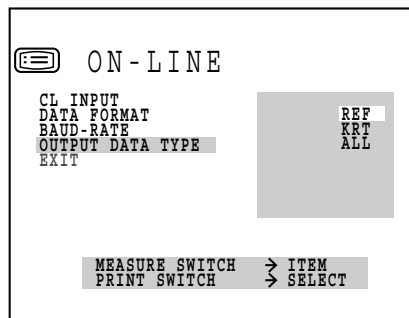

- 2 Press the **PRINT SWITCH** and choose  
REF (data of refractometer only),  
KRT (data of keratometer only), or  
ALL (data of both refractometer and keratometer).
- 3 Press the **MEASUREMENT SWITCH**, and the cursor moves to the next item.

## MENU SETTING

In menu setting, data step, contact/glasses, continuous measurement, RS232C, date and time can be set.

### PREPARATION FOR MENU SETTING

- 1 Make sure of the connection of power cable.  
For connection, see "CONNECTING POWER CABLE" on page 20.
- 2 Press "ON" the power switch.

### DISPLAYING MENU SCREEN

- 1 Make sure of the measurement screen.
- 2 Press the **MENU SWITCH** of the control panel.  
Make sure of the "SETTING MENU SCREEN".

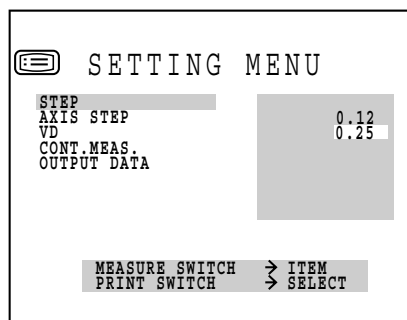

### RETURNING TO THE MEASUREMENT SCREEN

- 1 Press the **MEASUREMENT SWITCH**, invert "EXIT", and press **PRINT SWITCH**.

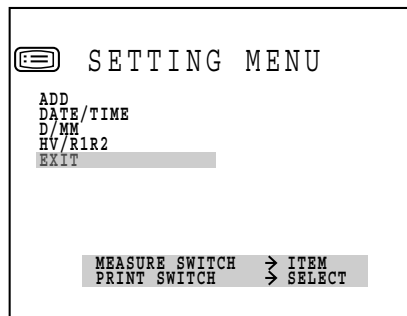

## SETTING STEP

The measurement step can be selected from 0.12, 0.25. Before shipment, it is set to "0.25".

- 1 Press the **MENU SWITCH** of the control panel and get the "SETTING MENU SCREEN". "STEP" is inverted, and measurement steps are displayed on the right with the set step inverted.
- 2 Press the **PRINT SWITCH** and invert the desired measurement step.

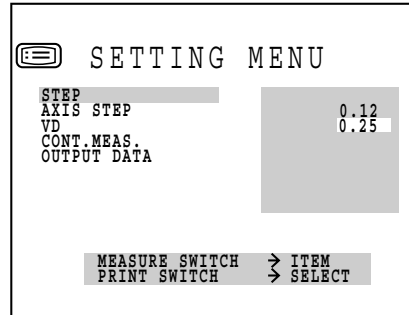

- 3 Press the **MEASUREMENT SWITCH**, and the cursor moves to the next item (AXIS STEP).

## SETTING AXIS STEP

The axial angle step can be selected from 1 and 5. Before shipment, it is set to "1".

- 1 Press the **MENU SWITCH** of the control panel and get the "SETTING MENU SCREEN".
- 2 Press the **MEASUREMENT SWITCH** and invert "AXIS STEP". "AXIS figures" are displayed on the right.
- 3 Press the **PRINT SWITCH** and invert the desired "AXIS" figure.

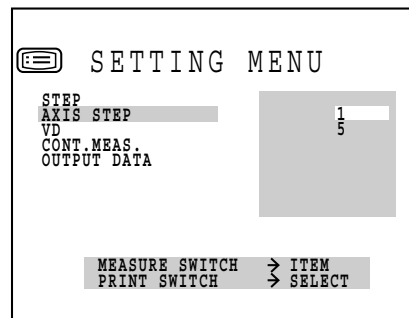

- 4 Press the **MEASUREMENT SWITCH**, and the cursor moves to the next item (VD).

## SETTING VD

In VD setting, contact (0) or glasses (12mm or 13.75mm) can be selected. Before shipment, it is set to glasses (12mm).

- 1 Press the **(MENU SWITCH)** of the control panel and get the "SETTING MENU SCREEN".
- 2 Press the **(MEASUREMENT SWITCH)** and invert "VD".  
VD figures are displayed on the right.
- 3 Press the **(PRINT SWITCH)** and invert the desired "VD" figure.

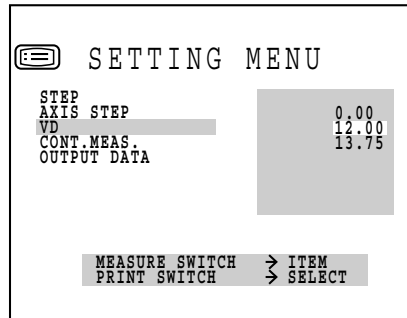

- 4 Press the **(MEASUREMENT SWITCH)**, and the cursor moves to the next item (CONT.MEAS.) .

## SETTING CONT.MEAS.

Continuous measurement can be set. Before shipment, it is set to "NO" (normal measurement).

- 1 Press the **(MENU SWITCH)** of the control panel and get the "SETTING MENU SCREEN".
- 2 Press the **(MEASUREMENT SWITCH)** and invert "CONT.MEAS.". "YES" and "NO" are displayed on the right.
- 3 Press the **(PRINT SWITCH)** and invert "YES" for continuous measurement.

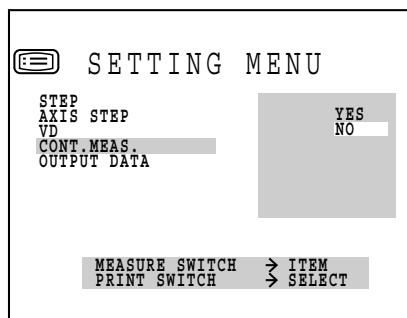

- 4 Press the **(MEASUREMENT SWITCH)**, and the cursor moves to the next item (OUTPUT DATA).



## SETTING OUTPUT DATA

The RS232C output can be set. Before shipment, it is set to “NO” (no output).

- 1 Press the **MENU SWITCH** of the control panel and get the “SETTING MENU SCREEN”.
- 2 Press the **MEASUREMENT SWITCH** and invert “OUTPUT DATA”.  
“YES” and “NO” are displayed on the right.
- 3 Press the **PRINT SWITCH** and invert “YES” for RS232C output.

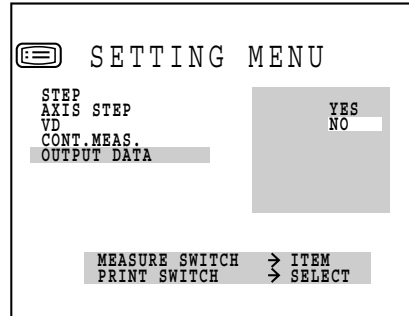

- 4 Press the **MEASUREMENT SWITCH**, and the cursor moves to the next item(ADD).

## SETTING ADD

By choosing an age, an ordinary additional power (ADD) can be selected for the age. Before shipment, it is set to “NO” (no setting).

- 1 Press the **MENU SWITCH** of the control panel and get the “SETTING MENU SCREEN”.
- 2 Press the **MEASUREMENT SWITCH** and invert “ADD”.  
The age bracket is displayed with the set bracket inverted on the right.
- 3 Press the **PRINT SWITCH** and invert the desired age bracket.

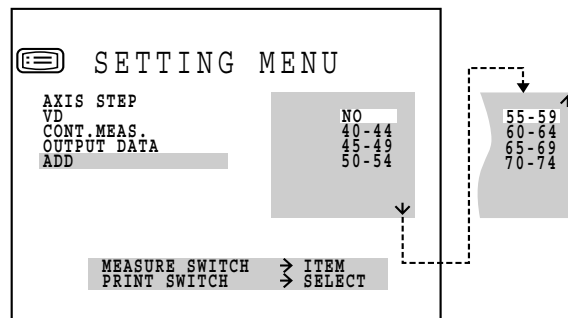

- 4 Press the **MEASUREMENT SWITCH**, and the cursor moves to the next item(DATE/TIME).



For “ADD”setting, set “ADD MODE” to “YES” in the initial set screen.  
To set “ADD MODE” to “YES”, see “ADD FACTOR” on page 26.

## SETTING DATE/TIME

- 1 Press the **(MENU SWITCH)** of the control panel and get the "SETTING MENU SCREEN".
- 2 Press the **(MEASUREMENT SWITCH)** and invert "DATE/TIME".  
The date/time is displayed on the right.
- 3 Press the **(PRINT SWITCH)** and invert the desired item.  
Change figures by pressing the **(MENU SWITCH)** (increase) or **(IOL SWITCH)** (decrease).

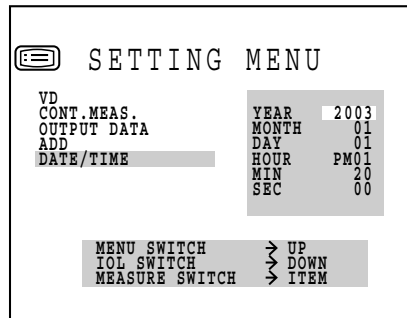

- 4 Press the **(MEASUREMENT SWITCH)**, and the cursor moves to the next item(D/MM).

## SETTING D/MM (Only in KR-8800)

The unit of cornea measurement result displayed on the monitor screen can be selected from D (refractive power) or MM (curvature). Before shipment, the setting is MM (curvature).

- 1 Press the **(MENU SWITCH)** and get the menu screen.

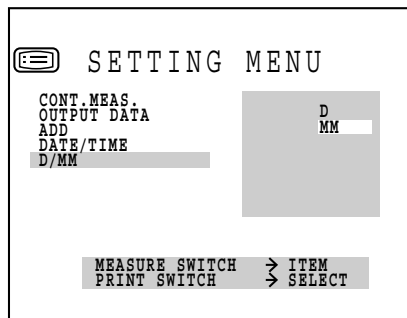

- 2 Press the **(MEASUREMENT SWITCH)** and invert "D/MM".
- 3 Press the **(MEASUREMENT SWITCH)** and invert the unit of measurement result to be set.
- 4 Press the **(MEASUREMENT SWITCH)**, and the cursor moves to the next item(HV/R1R2).

### SETTING HV/R1R2 (Only in KR-8800)

You can select how the cornea measurement is displayed on the monitor screen from either HV (horizontal/vertical direction) or R1R2 (radius of curvature of strong/weak principal meridian). When shipped, the HV(horizontal/vertical direction) is selected as the default setting.

- 1 Press the **MENU SWITCH** to call up the menu screen. The HV/R1R2 cursor is inverted and the measurement step is displayd on the right.

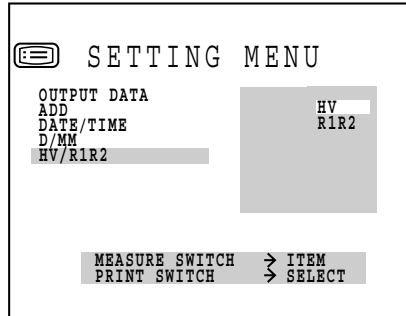

- 2 Press the **MEASUREMENT SWITCH** and invert "HV/R1R2." The display method of the cornea measurement result is displayed on the right. The set display method is inverted.
- 3 Press the **PRINT SWITCH** and invert the display method of the cornea measurement result you want to set.

R1: Radius of curvature of weak principal meridian  
R2: Radius of curvature of strong principal meridian

- 4 Press the **MEASUREMENT SWITCH**, and the cursor moves to the next item (EXIT).

## PRINTER PAPER SETTING

### AUTO SETTING

<b>NOTE:</b>	<ul style="list-style-type: none"><li>• Note that printing cannot be done if the paper back faces up by setting the roll in opposite direction.</li></ul>
<b>NOTE:</b>	<ul style="list-style-type: none"><li>• Please insert the paper deep enough into the printer. otherwise the paper may not come out. At this time "PAPER END" will be displayed on the monitor.</li></ul>

- 1** While pressing the thumb to the surface, slide off the printer cover.

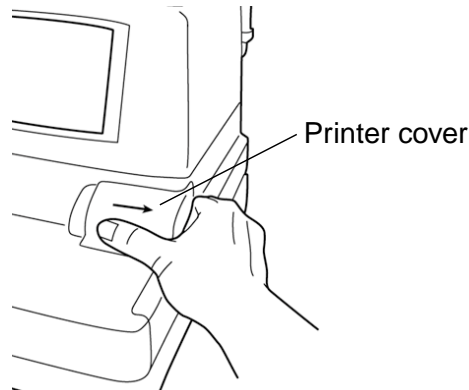

- 2** Turn the paper retainer lever to the illustrated position.

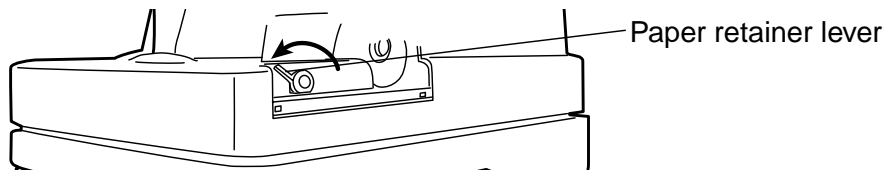

- 3** Set the paper into the shaft support, taking care of the roll direction of paper. Pull out the paper top 7-8cm forward.

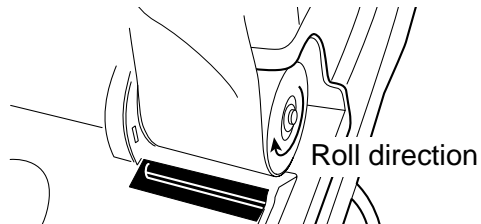

- 4** Insert the paper straight along the paper guide.

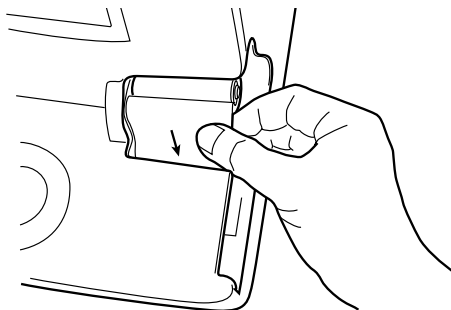

- 5** Turn the paper roll backward to remove any sag.

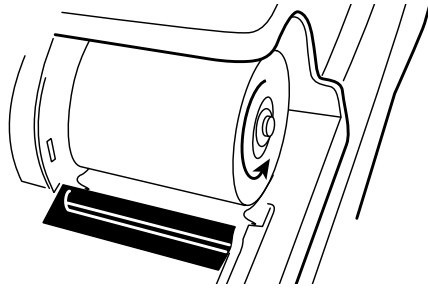

- 6** Feed the paper with your finger.

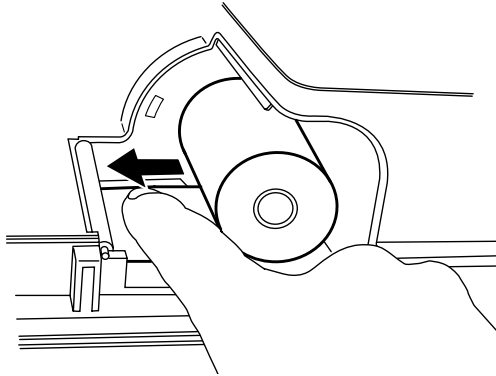

- 7** Reset the paper retainer lever to the original upright position.

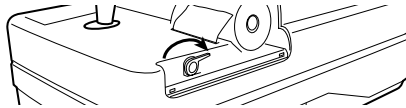

- 8** While pressing the paper to the printer, press the **PRINT SWITCH** continuously until it is inserted deep enough and fed forward.

- 9** When the paper top protrudes about 1cm from the printer, release the **PRINT SWITCH**. Be sure to hold the paper top so that it is not caught in the main paper roll.

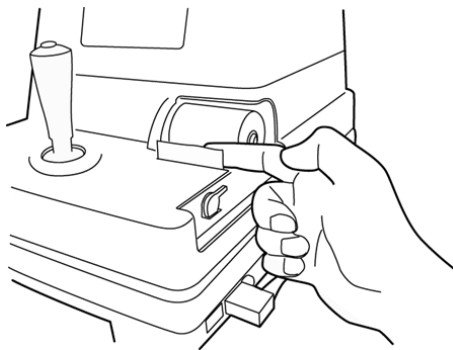

**10** After making sure that the paper comes out, attach the printer cover.

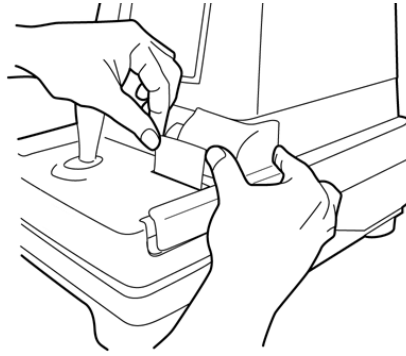

Please insert the printer cover until it clicks.



A 58mm wide paper roll (example: TF50KS-E2C [Nippon Paper Co.]) is recommended.

Other paper rolls may cause unnecessarily large printing noise or unclean printing.

## MANUAL SETTING

- 1** While pressing the thumb to the surface, slide off the printer cover.
- 2** Set the paper into the shaft support, taking care of the roll direction of paper. Pull out the paper top 7-8cm forward.
- 3** Rotate the paper retainer lever in the arrow direction.

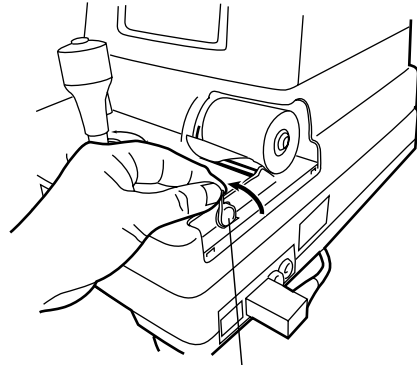

Paper retainer lever

- 4** Set the paper retainer lever at the illustrated position where it becomes a little heavier.

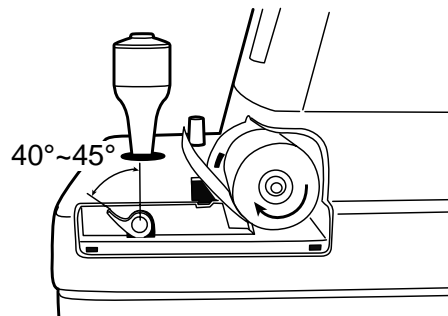

- 5** Cut the paper about 2cm from the control lever side, as illustrated.

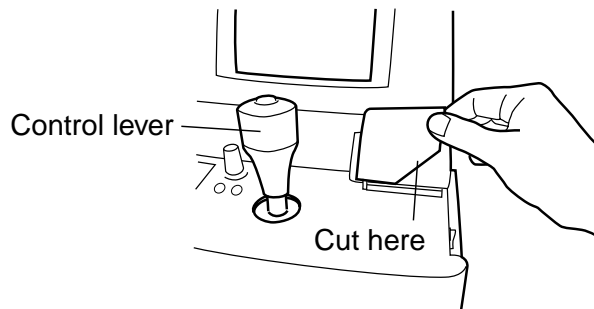

- 6** Insert the paper into the printer straight along the paper guide.

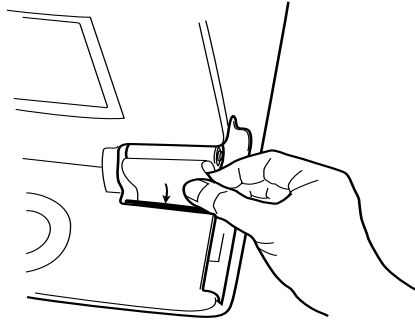

- 7** Turn the paper roll backward to remove any sag.

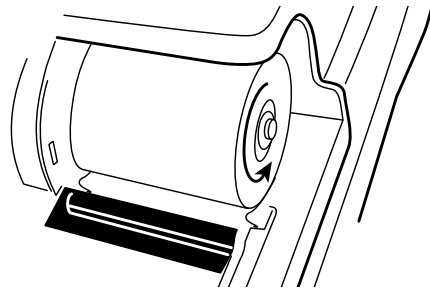

- 8** Feed the paper with your finger.

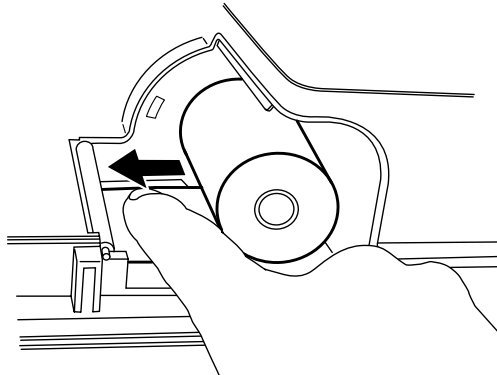

- 9** Insert the paper further until the paper top comes out from the outlet.

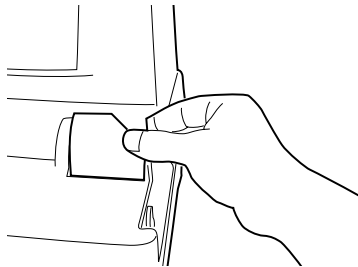

If the paper retainer lever is not set to the proper position or if the paper is not cut on the control lever side, the paper does not go smoothly into the printer.



**10** Align the paper so that it comes out straight and then lower the paper retainer lever to the level position.

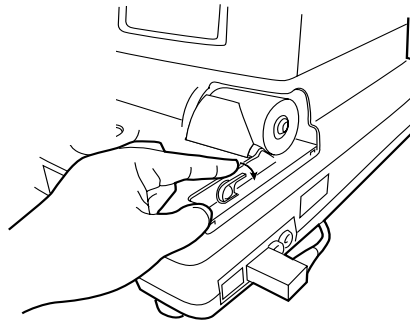

**11** Attach the printer cover so that the paper comes outside.

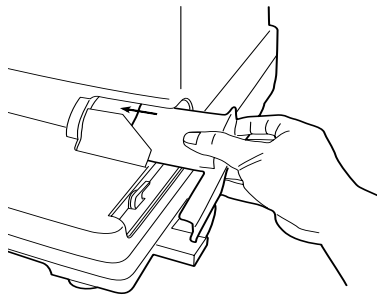

Please insert the printer cover until it clicks.



The paper retainer lever can be set in 2 steps. If a paper jam occurs, fully rotate the paper retainer lever to the illustrated position, and remove the stuffed paper pieces from the printer.

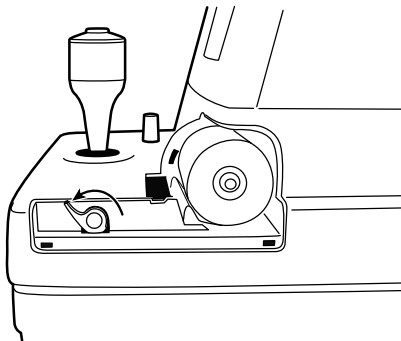

## **RESETTING FROM POWER SAVE STATUS**

This instrument adopts the power save system for saving electric power. Namely, when the main body is not in operation, power supply to the monitor and CCD camera is stopped. Under the power-save condition, only the POWER lamp of control panel lights and the monitor screen is off.

**1** Press the **MEASUREMENT SWITCH**.

In a few seconds, the monitor is displayed and measurement is enabled.

# BASIC OPERATIONS

## PREPARATION BEFORE MEASUREMENT

### APPLYING POWER SOURCE

- 1** Make sure of the connection of power cable.  
For connection, see “CONNECTING POWER CABLE” on page 20.
- 2** Press on the **POWER SWITCH**.
- 3** Confirm that the title screen is displayed and then the measurement screen is displayed in a few seconds.

### POSITIONING THE PATIENT



#### CAUTION

To avoid injury, do not insert fingers under the chinrest.  
\*Be sure to instruct the patient about this.

- 1** Make sure of the measurement screen.
- 2** Let the patient sit in front of the instrument.
- 3** Adjust the automatic instrument table or the chair height so that the patient can sit on the chair with comfort.
- 4** Place the patient's chin on the chinrest and let his forehead touch the forehead rest.



- 5** Adjust the chinrest height so that the patient's eye becomes level with the eye height mark.

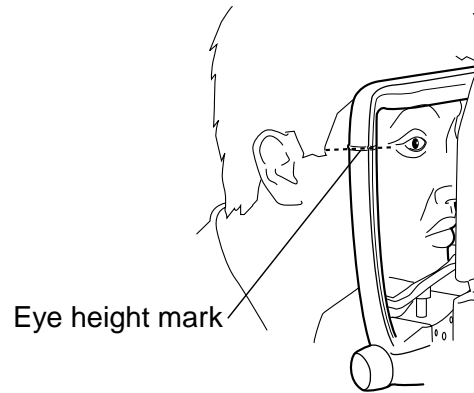

## MEASUREMENT UNDER AUTO START MODE (ONLY IN KR-8800)

<b>NOTICE</b>	<ul style="list-style-type: none"><li>Adjust the height of automatic instrument table so that the patient can sit on the chair with comfort to obtain correct measurement values.</li></ul>
---------------	---

### POSITIONING THE PATIENT

In the initial status after power on, the mode is set to the auto start.

- 1 Make sure of the measurement screen.
- 2 Press **AUTO START SWITCH** on the control panel and display the alignment bar in the monitor screen.

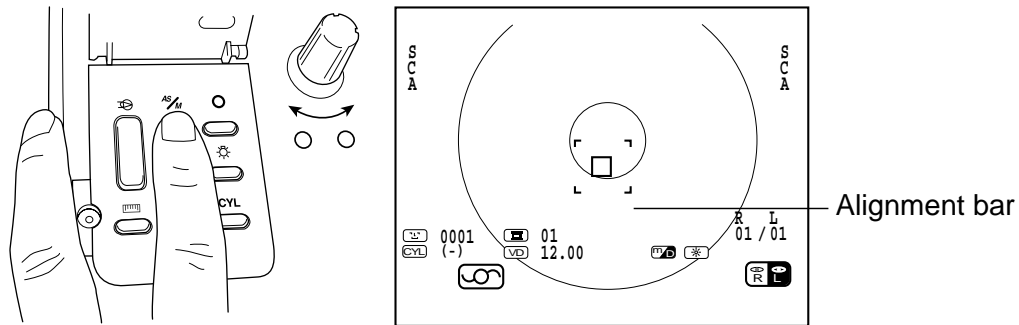

### SETTING THE MEASUREMENT MODE

This instrument can change the measurement mode R/K (REF-KRT continuous measurement, KRT, REF).

In the initial status after power on, the measurement mode is R/K.

- 1 Make sure of the measurement screen.
- 2 Press **MEASUREMENT MODE SWITCH** of the control panel and set the measurement mode.

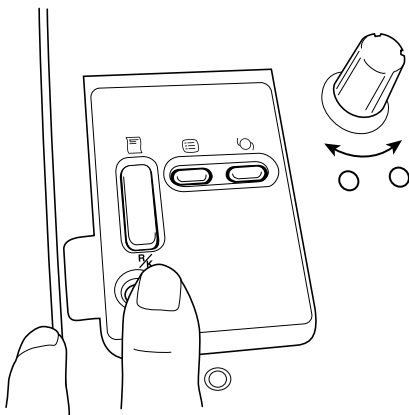

## COLLIMATION AND MEASUREMENT (ADJUSTING THE PATIENT'S EYE TO AUTO REFRACTOMETER)

Alignment operations are done with the control lever.



Movement operations of the main body using the control lever.

- The main body position can be fine-adjusted laterally by inclining the control lever to each direction.

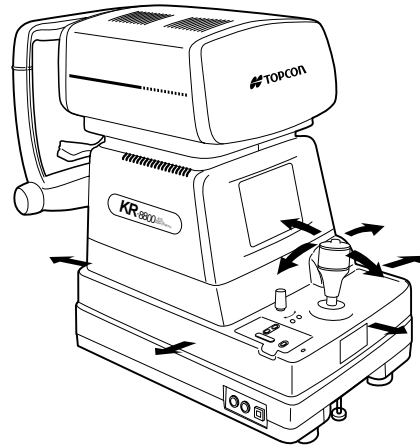

Operating the control lever  
(for lateral adjustment)

- The main body position can be fine-adjusted vertically by turning the control lever right (up) and left (down).

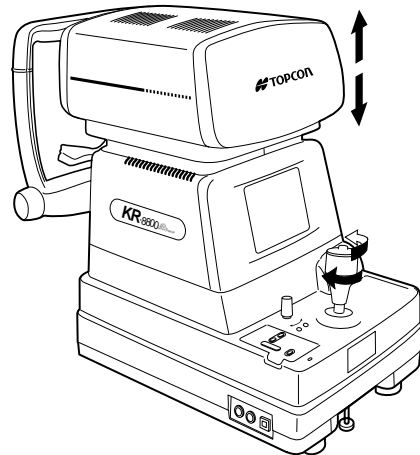

Operating the control lever  
(for up/down adjustment)

- 1 Hold the control lever and move the main body to the operator side.

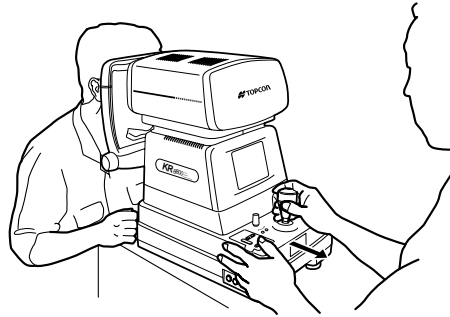

- 2 Operate the control lever laterally and vertically to obtain the target eye in the center of monitor screen.

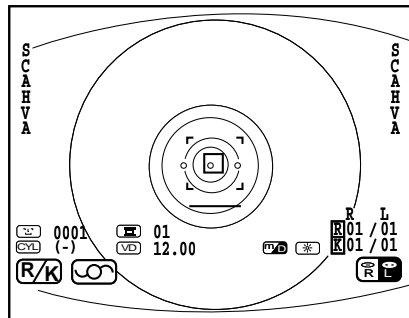

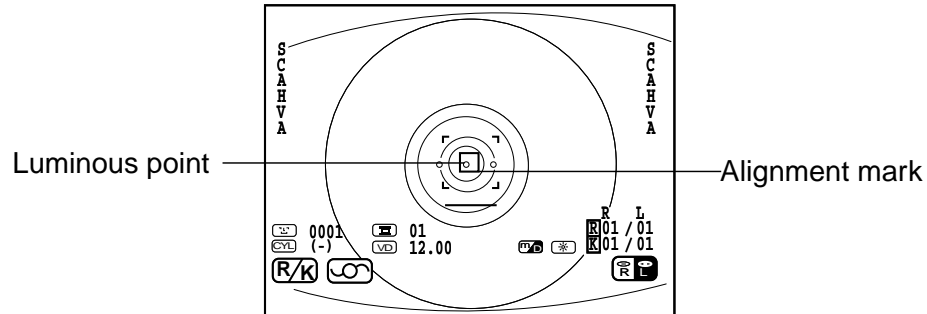

- 3 While moving the main body toward the patient, focus the target eye. A vague, reflected luminous point for alignment appears on the cornea.

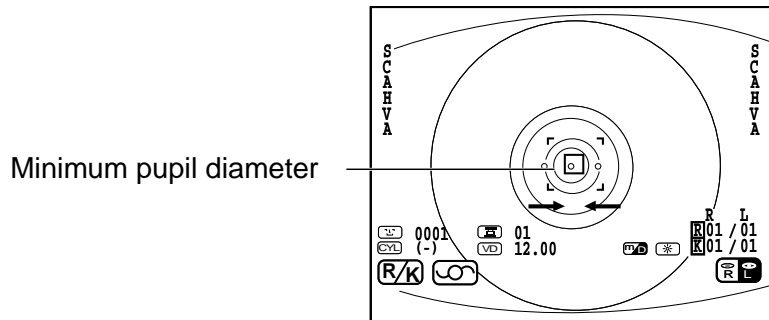

- 4 Fine-adjust the main body position in all directions so that the luminous point comes within the alignment mark.

- 5** Keeping the luminous point within the alignment mark, slowly move the main body toward the patient.  
When the main body approaches the target eye, the alignment bar of the monitor screen changes to arrows.



 Take care so that eyelashes and eyelid do not come into the minimum pupil diameter mark as they may disturb measurement.

 If the instrument is too close to the alignment reference position, “ ” is displayed on the monitor screen, and if too far, “ ” is displayed.

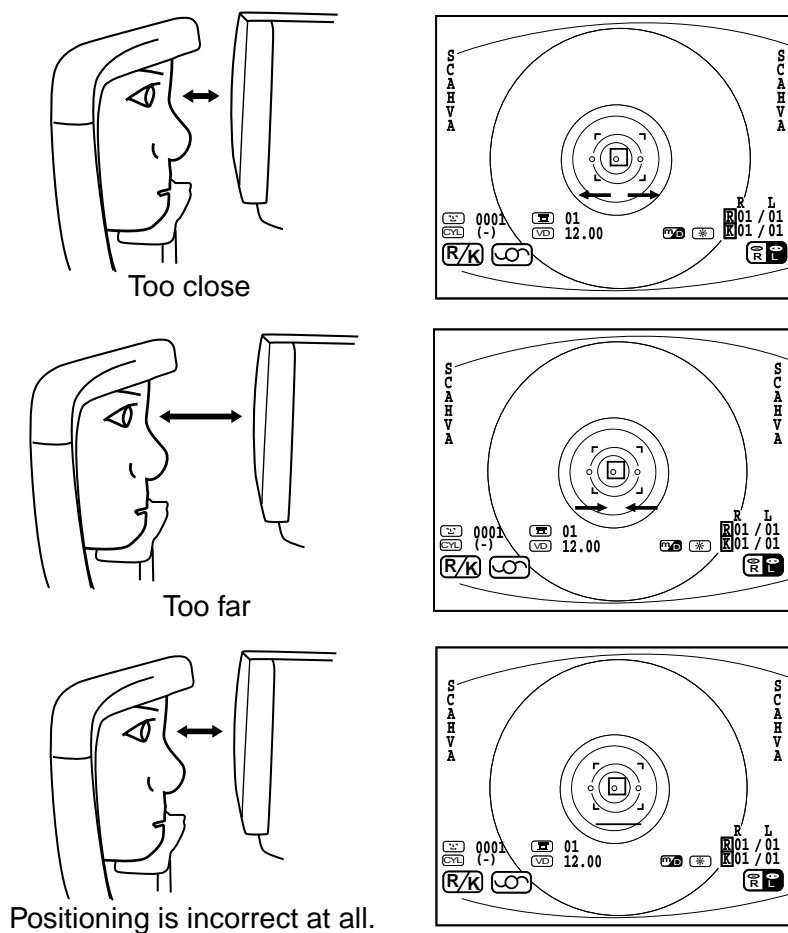



- 6** After the alignment bar is displayed, move the main body slowly towards the patient. Measurement is done and the measurement value is displayed on the monitor screen.

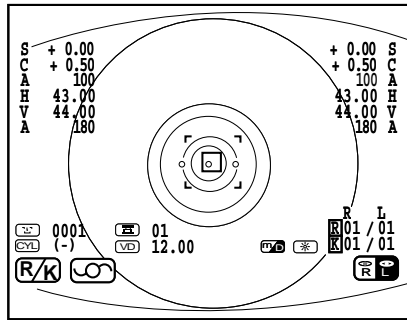

- To stop auto start  
Press the **MEASUREMENT SWITCH**, and release it after hearing the buzzer sounds twice. Auto measurement is stopped. To return to auto measurement, press the **AUTO START SWITCH** again.  
After stopping the measurement, the measurement result is printed out by pressing the **PRINT SWITCH**.



- To automatically print the measurement result (available at auto start mode only)  
If YES is selected for auto print in the initial setting, press the **MEASUREMENT SWITCH** after right and left measurements are finished. The buzzer sounds twice, and the measurement result is printed out automatically.

<b>NOTICE</b>	<ul style="list-style-type: none"> <li>If measurement is not possible under auto start mode (this may occur when the cornea condition is not good), measure under manual start mode.</li> </ul>
---------------	---

### DISPLAYING MEASUREMENT VALUES

Data of the latest measurement are displayed on the monitor screen.

Figures only: Measurement was done correctly.

ERROR: Measurement was not done correctly.



For messages on the monitor screen, see "Messages given during measurement" on page 75.

## MEASUREMENT UNDER MANUAL MODE

### NOTICE

- Adjust the height of automatic instrument table so that the patient can sit on the chair comfortably to obtain accurate measurement values.

### SETTING THE PICTURING MODE

In the initial status after power on, the mode is set to the auto start.

- 1 Check of the measurement screen.
- 2 Press **AUTO START SWITCH** on the control panel and erase the alignment bar from the monitor screen.

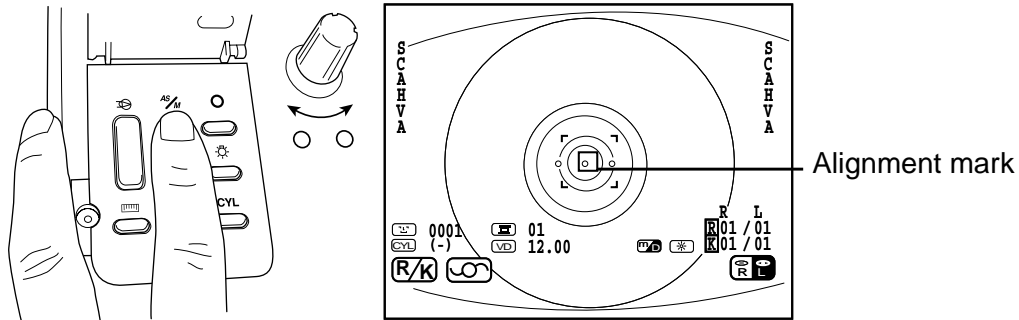

### COLLIMATION AND MEASUREMENT

Alignment operations are done with the control lever.

For the adjustment of main body using the control lever, see MEMO on page 60.

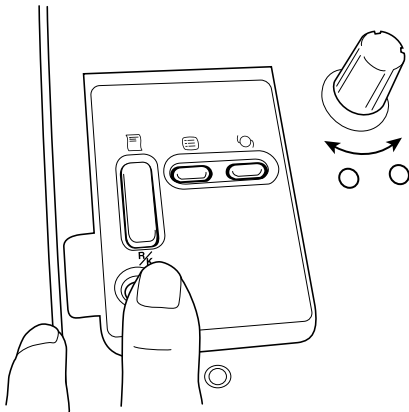

- 1 Operate the control lever laterally and vertically so as to obtain the target eye in the center of monitor screen.

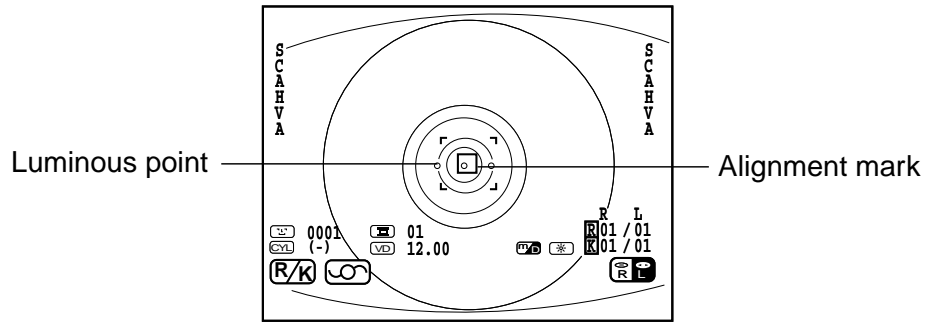

- 2 While moving the main body toward the patient, focus the target eye. A vague, reflected luminous point for alignment appears on the cornea. Focus the target eye to make the luminous point minimum.
- 3 Fine-adjust the main body position in all directions so that the luminous point comes within the alignment mark.

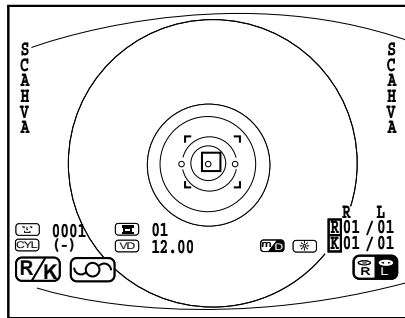

- 4 When the luminous point becomes the minimum within the alignment mark, press the **MEASUREMENT SWITCH**.



Even when collimation is improper, measurement is done by pressing the **MEASUREMENT SWITCH**, but to secure high-precision values, do collimation properly.

- 5 Measurement is done and measurement values are displayed.

## ERASING MEASUREMENT VALUES

- 1 While pressing the **MENU SWITCH** of the control panel, press the **PRINT SWITCH**. All measurement values, both right and left eyes are cleared, and the system returns to the initial status after power on.

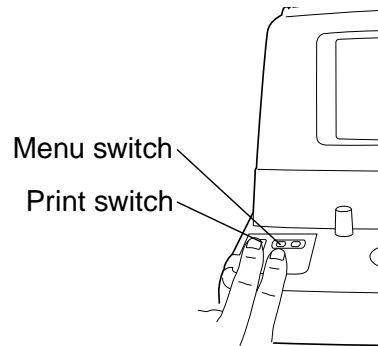

# INDIVIDUAL OPERATIONS

## PRINT-OUT OF MEASUREMENT VALUES

<b>NOTICE</b>	<ul style="list-style-type: none"><li>• To avoid paper jam in the printer, do not feed the paper if it is partly cut/torn or wrinkled.</li><li>• To avoid discoloring the printing paper (particularly the recording area) during storage, use a polypropylene holder and not one containing plasticizer (PVC, etc.).</li><li>• To avoid discoloring the printing paper (particularly the recording area) after pasting, use water soluble glue and not one containing solvent.</li><li>• Since the printer paper is heat sensitive, it is not suitable for recording for a long period. If necessary to keep records for long, we recommend to take copies separately.</li></ul>
---------------	---

This instrument is equipped with a built-in printer to print out measurement values.

**1** Confirm the measurement screen.

**2** Press the **PRINT SWITCH** of the control panel.

Measurement values of the monitor screen are printed out. After printing, the values are erased automatically from the monitor screen.

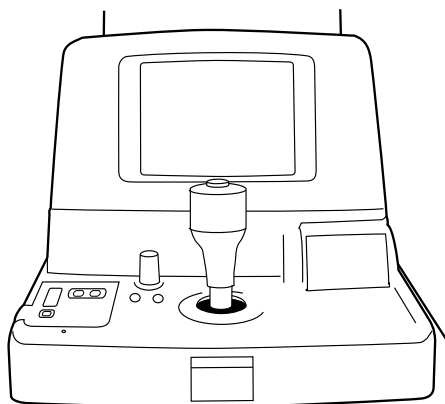

The “ERR” mark is not printed. Also, printing is not done if there is no measurement value. When a red line appears in the printer paper, replace it with new one. For details about the replacement of printer paper, see “PRINTER PAPER SETTING” on page 50. Additionally, a 58mm wide paper roll (example: TF50KS-E2C [Nippon Paper Co.]) is recommended.



If “PRINTER HEAD UP” is displayed, lower the paper retainer lever and press the **PRINT SWITCH** again.

- 3** To cut the paper, hold the top left corner and pull it diagonally, as illustrated.

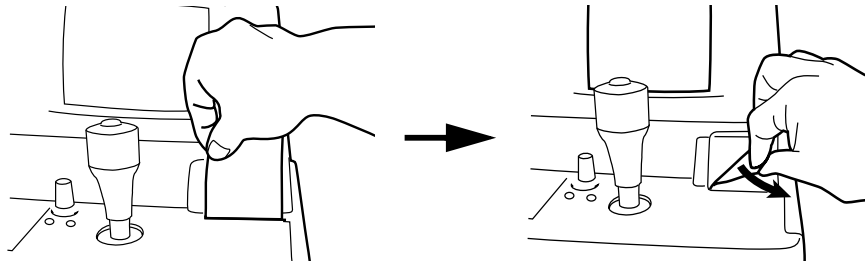

**NOTICE**

- Irregular cutting may cause paper jam.  
Cut the paper cleanly.

## MEASUREMENT OF CORNEA DIAMETER (ONLY IN KR-8800)

For the measurement of cornea diameter, "C.D MEMORY YES" (measurement of static image) or "C.D MEMORY NO" (measurement of dynamic image) can be selected in the initial setting.

For changing settings, see "Changing the cornea diameter measurement method (Only in KR-8800)" on page 25.

### MEASURING THE DYNAMIC IMAGE

- 1 Focus the target eye.

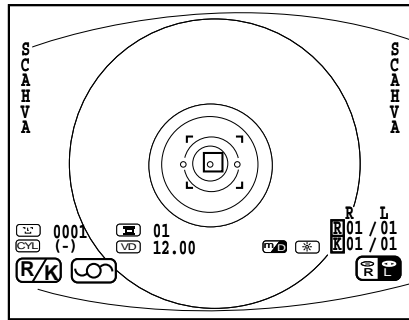

- 2 Press the **CORNEA DIAMETER SWITCH**.

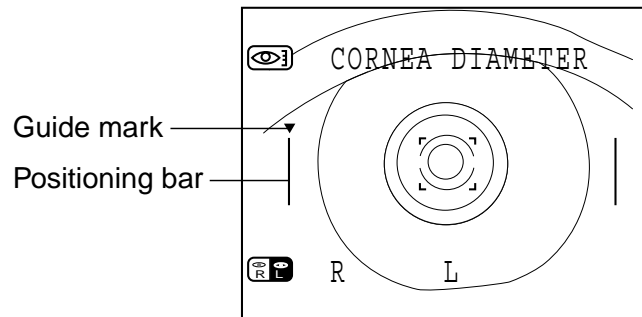

- 3 Observe of the cornea diameter screen.

- 4** Bring the left positioning bar to the left end of iris by pressing the **AUTO START SWITCH** (for moving left) and **TARGET IMAGE SWITCH** (for moving right).

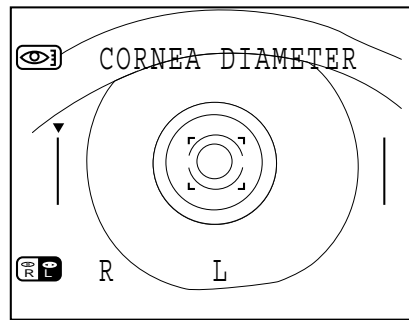

- 5** Press the **MEASUREMENT SWITCH**.
- 6** The guide mark moves right.
- 7** Bring the right positioning bar to the right end of iris by pressing the **AUTO START SWITCH** (for moving left) and **TARGET IMAGE SWITCH** (for moving right).



If it is necessary to move the left positioning bar again, press the **MEASUREMENT MODE SWITCH**. When the **MEASUREMENT MODE SWITCH** is pressed further, right and left positioning bars return to the initial positions.

- 8** Press the **MEASUREMENT SWITCH**.
- 9** The cornea diameter is displayed.

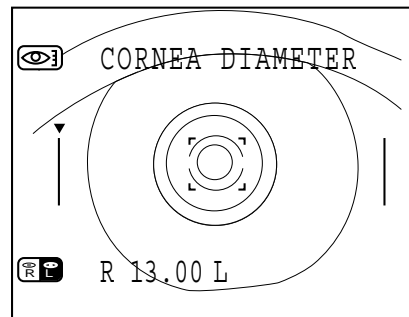

- 10** Press the **MEASUREMENT SWITCH**. The measurement mode of left eye sets in. Measure also the right eye in like manner.
- 11** After displaying data for both eyes, press the **MEASUREMENT SWITCH** to return to the measurement screen.





- To get out of the mode during measurement, press the **PRINT SWITCH**.
- When the measurement result is necessary for one eye only, do the measurement and then press the **PRINT SWITCH** and get out of the mode.
- Under the REF mode, the measurement of cornea diameter cannot be done.

## MEASURING THE STATIC IMAGE

**1** Focus the target eye.

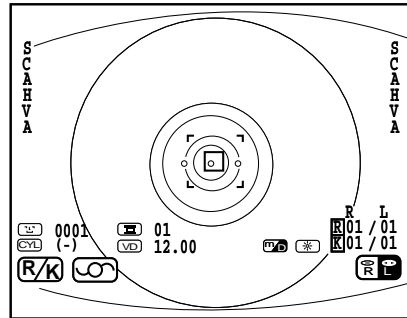

**2** Press the **CORNEA DIAMETER SWITCH**.

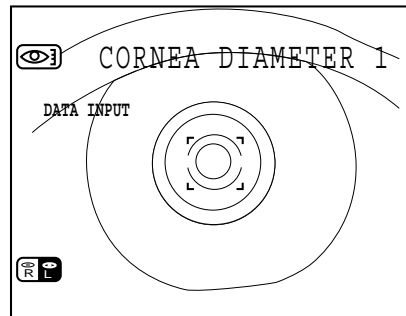

**3** Make sure of the cornea diameter screen.

**4** Press the **MEASUREMENT SWITCH**. The image of right eye is stored and the memory counter of screen changes to "1".



When the **MEASUREMENT SWITCH** is pressed repeatedly, the memory counter remains as is "1", but the latest image is stored.

**5** Store the image of left eye in like manner.

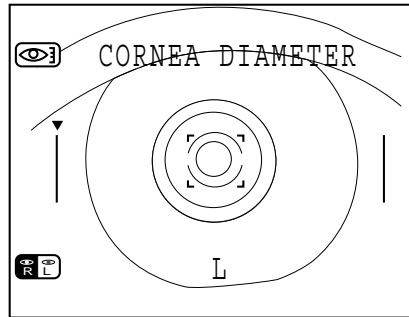

(Measuring the left eye only)

**6** Press the **CORNEA DIAMETER SWITCH**.

**7** Make sure of the cornea diameter screen.

**8** Bring the left positioning bar to the left end of iris by pressing the **AUTO START SWITCH** (for moving left) and **TARGET IMAGE SWITCH** (for moving right).



If it is necessary to move the left positioning bar again, press the **MEASUREMENT MODE SWITCH**. When the **MEASUREMENT MODE SWITCH** is pressed further, right and left positioning bars return to the initial positions.

**9** Press the **MEASUREMENT SWITCH**. The cornea diameter is displayed.

**10** Press the **MEASUREMENT SWITCH**. The measurement mode of left eye sets in.

Measure also the left eye in like manner.



- When the image of only one eye is necessary, press the **CORNEA DIAMETER SWITCH** after storing the image.
- When images of both eyes are stored, the left/right eye screen can be switched by pressing the **CORNEA DIAMETER MEASUREMENT SWITCH**.

## **MEASUREMENT OF HARD CONTACT LENS**

- 1** Make sure the unit is in the corneal curvature measurement (R/K or KRT) mode. If not, choose the R/K or KRT mode by the **MEASUREMENT MODE SWITCH**.
- 2** Fill the concave part at the top of contact lens holder of model eye with water, and paste the contact lens.
  - The contact lens adheres by surface tension.
  - Take care not to allow bubbles in between.
  - Also take care and keep the measured lens surface free of water drops.

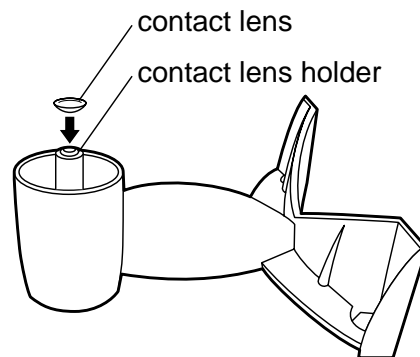

- 3** Insert the model eye into chinrest tissue pins.

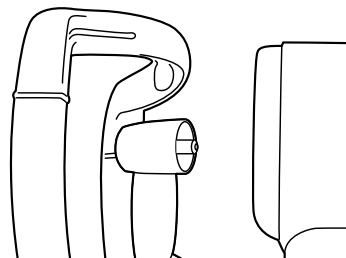

- 4** Do measurement in like manner as the corneal curvature measurement.
  - When measuring the base (concave) curve of contact lens, the axial angle is reversed from the normal (convex) corneal curvature measurement.

## **INPUT/OUTPUT USING RS232C**

### **OUTPUT USING RS232C**

This instrument can output data to PC and the like via the RS232C interface.

- 1** Make sure of the connection to RS232C OUT.  
For connection, see “CONNECTING EXTERNAL I/O TERMINALS” on page 20.
- 2** Make sure of data communication settings.  
For data communication settings, see “ON-LINE (DATA COMMUNICATION)” on page 41.
- 3** Do measurements.
- 4** Press the  of the control panel.  
When output is completed, “DATA OUT” is displayed in the monitor screen.

### **INPUT USING RS232C**

This instrument can input ID numbers from a bar code reader and the like via the RS232C interface.

- 1** Make sure of the connection of RS232C OUT.  
For connection, see “CONNECTING EXTERNAL I/O TERMINALS” on page 20.
- 2** Make sure of data communication settings.  
For data communication settings, see “ON-LINE (DATA COMMUNICATION)” on page 41.
- 3** Confirm the measurement screen.
- 4** Input ID numbers from the external device.  
The input ID numbers are displayed in the monitor screen.



# TROUBLESHOOTING

## TROUBLE-SHOOTING OPERATIONS

### MESSAGES GIVEN DURING MEASUREMENT

"OVER-SPH"	Spherical power exceeds +22D or -25D.
"OVER-CYL"	Cylindrical power exceeds $\pm 10D$ .
"OVER-R"	Indicates that the corneal curvature exceeds 5.00-10.00mm.
"NO TARGET"	This indicates there is no target eye or the eye image is too dark.
"AGAIN"	There is a difference of more than 5D from the previous measurement value.
"NO CENTER"	There is no target eye center.
"ALIGN ERR"	The alignment is significantly failed during the measurement.
"PAPER END"	Paper is used up.
"PRINT HEAD UP"	The paper retainer lever is up.
"PRINT"	Printing is under way.
"ERROR"	The patient's eye blinks or moves during measurement. If this appears when proper measurement is done with the model eye, something is wrong in the instrument: Ask our serviceman.

## TROUBLE-SHOOTING OPERATIONS

 <b>WARNING</b>	To avoid electric shocks, do not attempt overhauling, rebuilding or repairs. Ask your dealer for repair.
 <b>WARNING</b>	To avoid electric shocks, do not remove covers from bottom and top surfaces, monitor, measuring unit, etc.

If a trouble is suspected, check conditions following the check list shown below.  
 If the disposition according to the given instructions does not improve the condition, or if there is no relevant check item in the list, contact your dealer or TOPCON to the address stated on the back cover.

### CHECK LIST

Trouble	Condition	Check	Page
monitor does not work.	Pilot lamp does not light either.	Is power cable unplugged?	20
		Is power cable connected to the instrument?	20
	Fuse blows when POWER switch is pressed on.	Call our serviceman.	83
monitor is hard to see.	Picture is dark.	Adjust "BRIGHT" volume.	82
Something is wrong with control lever (or another movable part).		Do not move it forcibly but call our serviceman.	60
Printing is not done.	Paper comes out without printing.	Is paper roll direction correct?	50
	Paper does not come out.	Is "PAPER END" displayed on monitor? If so, Replenish printer paper.	50

# SPECIFICATIONS AND PERFORMANCE

RM - 8800

Measuring range	Hyperopia: 0 to +22D 0.25D step display (switchable to 0.12D step display) Myopia: 0 to -25D 0.25D step display (switchable to 0.12D step display) Astigmatism: 0 to 10D 0.25D step display (switchable to 0.12D step display) Axial angle: 0 to 180° 1° step display (switchable to 5° step display)
Minimum pupil diameter measurable	2.0φmm
Target fixation	Auto fog system
Measurement data display	Monitor screen
Measurement data recording	Built-in printer (Data of 10 measurements of right and left eyes)
Display of measurement value	Display in monitor screen.
Recording of measurement value	Built-in printer (recordable up to 10 measurements each for right/left eye)
Collimation	Monitor screen
Monitor	5"
PD measurement	20-85mm, 1mm display unit
External output terminal	RS232C
Operating temperature	10-40°C
Main body travel	back & forth: 43mm, sides: 92mm, up & down: 30mm
Chinrest travel	60mm (up & down)
Dimensions	275(W)x475(D)x450(H)mm
Weight	20kg

## KR - 8800

Measuring range	Hyperopia: 0 to +22D 0.25D step display (switchable to 0.12D step display) Myopia: 0 to -25D 0.25D step display (switchable to 0.12D step display) Astigmatism: 0 to 10D 0.25D step display (switchable to 0.12D step display) Axial angle: 0 to 180° 1° step display (switchable to 5° step display)
Corneal curvature measurement Measuring range	Radius of corneal curvature: 5.00 to 10.00mm 0.01mm step display Corneal refractory power: 67.50 to 33.75D 0.25D step display (switchable to 0.12D step display) (corneal refractive index = 1.3375) Corneal astigmatic power: 0~10D (+ or -) Corneal astigmatic axial angle: 0~180° 1° step display (switchable to 5° step display)
Minimum pupil diameter measurable	2.0φmm
Target fixation	Auto fog system
Measurement data display	Monitor screen
Measurement data recording	Built-in printer (Data of 10 measurements of right and left eyes)
Display of measurement value	Display in monitor screen.
Recording of measurement value	Built-in printer (recordable up to 10 measurements each for right/left eye) (R/K mode: printing of typical values only)
Collimation	Monitor screen
Monitor	5"
PD measurement	20-85mm, 1mm display unit
External output terminal	RS232C
Operating temperature	10-40°C
Main body travel	back & forth: 43mm, sides: 92mm, up & down: 30mm
Chinrest travel	60mm (up & down)
Dimensions	275(W)x475(D)x450(H)mm
Weight	20kg

\*For product improvements, these specifications are subject to change without notice.

**CLASSIFICATION : IEC 60601-1 CLASS I TYPE B**



## **ELECTROMAGNETIC COMPATIBILITY**

This product conforms to the EMC standard (IEC60601-1-2:2001).

## **ELECTRIC RATING**

### **Except U.S.A and Canada**

Source voltage: 100-120V, 220-240V AC, 50/60Hz

Power input: RM-8800:60VA KR-8800:75VA

### **U.S.A and Canada**

Source voltage: 120V AC, 50/60Hz

Power input: RM-8800:60VA KR-8800:75VA

## **SYSTEM CLASSIFICATION**

- Degree of protection against harmful ingress of water: IPx0  
RM-8800 and KR-8800 has no protection against ingress of water. (The degree of protection against harmful ingress of water defined in IEC 60529 is IPx0)
- Classification according to the method(s) of sterilization or disinfection recommended by the manufacturer: not applicable.  
RM-8800 and KR-8800 has no part to be sterilized or be disinfected.
- Classification according to the degree of safety of application in the presence of a flammable anaesthetic mixture with air or with oxygen or nitrous oxide: Equipment not suitable for use in the presence of a flammable anaesthetic mixture with air or with oxygen or nitrous oxide.  
RM-8800 and KR-8800 should be used in environments where no flammable anesthetics and/or flammable gases are presents.
- Classification according to the mode of operation: Continuous operation.  
Continuous operation is the operation under normal load for an unlimited period, without the specified limits of temperature being exceeded.

## **PURPOSES OF USE**

### **RM-8800**

This instrument is used to measure the spherical refractive power, cylindrical refractive power, the direction of astigmatic axis.

### **KR-8800**

This instrument is used to measure the spherical refractive power, cylindrical refractive power, the direction of astigmatic axis, the radius of curvature, the direction of principal meridian and the corneal refractory power.

# REFERENCE

## OPTIONAL ACCESSORIES

- Automatic instrument table AIT-15  
The table height can readily be adjusted to facilitate measurement.

### Specifications

- Dimensions .....510(W)x450(D)mm
- Table height.....600~820mm
- Table size .....490x500mm
- Weight.....approx. 23kg
- Power consumption...270VA (100-120V,220-240V)

- RS232C on-line cable

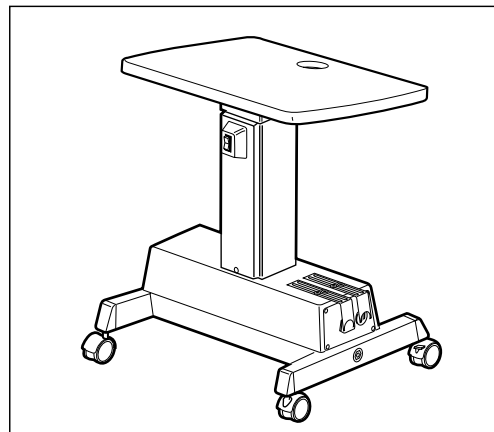

## SHAPE OF PLUG

Country	Voltage/frequency	Shape of plug
Mexico	110V/50Hz	Type C&E
Argentina	220V/60Hz	Type A
Peru	220V/60Hz	Type A
Venezuela	110V/50Hz	Type C&E
Bolivia & Paraguay	220V/60Hz	Type A (Most common) Type H (Infrequently)
Chile	220V/60Hz	Type A
Colombia	110V/50Hz	Type C
Brazil	220V/60Hz 127V/60Hz	Type A Type C
Ecuador	110V/50Hz	Type C&E

## SYMBOL

Symbol	IEC Publication	Description	Description (French)
	60417-5032	Alternation Current	Courant alternatif
	60348	Attention, consult accompanying documents	Attention, consulter les documents d'accompagnement
	60417-5008	Off (power: disconnection from the mains)	Éteint (courant: coupure avec le secteur)
	60417-5007	On (power: connection of the mains)	Allumé (courant: raccordement sur le secteur)
	60878-02-02	Type B applied part	Classe B

# MAINTENANCE

## DAILY CHECKUPS

### CHECKING THE MEASURING ACCURACY

- Measure the attached model eye and check the accuracy at regular intervals.

### CLEANING THE INSTRUMENT

- Dust on examination window ..... Blow off dust by a blower.
- Fingerprints and oil spots on examination window..... Blow off dust by a blower and wipe the surface lightly with a camera lens cleaner using clean gauze.
- Dirty instrument cover..... Wipe the surface with the attached silicon cloth or a dry soft cloth. Never use solvents or a chemical duster.

### CLEANING APPLIED PARTS

- Wipe the forehead rest and the chin rest with a cloth moistened with a tepid solution of neutral detergent for kitchenware.

### DAILY MAINTENANCE

- For this instrument, dust may cause errors. When not in use, apply the measuring lens cap and dust cover.
- When not in use, turn off the POWER switch.

### ORDERING CONSUMABLE ITEMS

- When ordering consumable items, tell the product name, product code and quantity to your dealer or TOPCON to the address stated on the back cover.

Product name	Product code
Chinrest tissue	40310 4082
Silicon cloth	31087 2007
Dust cover	42360 9002

Product name	Product code
Printer paper	44800 4001
Fuse T-3A,250V	41840 4014

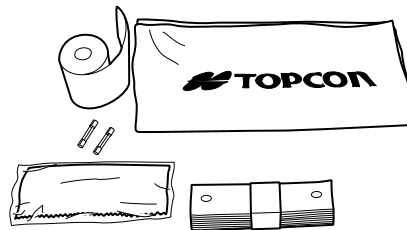

## ADJUSTING THE MONITOR SCREEN

- Though this instrument is properly adjusted before shipment, sometimes screen adjustment is required due to vibrations during transportation.
- To adjust contrast and brightness, turn volumes fully clockwise, viewed from the operator side, and then adjust each properly.

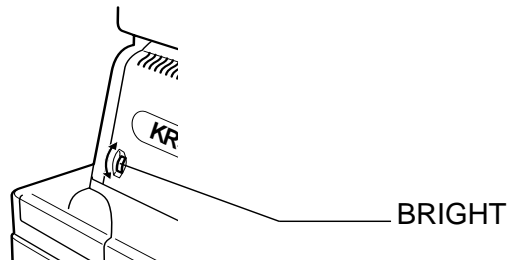



## PRINTER PAPER JAM

<b>NOTICE</b>	• If the printer paper is jammed in the printer, printing cannot be done, and continued use may cause troubles.
---------------	---

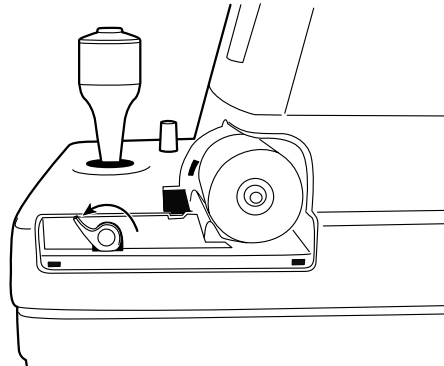
- 1** Remove the printer cover, and take out the jammed paper pieces with the paper retainer lever fully released.
- 2** The paper retainer lever can be set in 2 steps. If a paper jam occurs, fully rotate the paper retainer lever to the illustrated position.



## FUSE CHANGE

 <b>WARNING</b>	To avoid electric shocks during fuse change, be sure to unplug the power cable before removing the fuse lid. Also, do not plug the power cable leaving the fuse box open.
 <b>WARNING</b>	Always use the attached fuse (T-3A,250V). Using any other type may cause troubles and fire.

- 1** Make sure that the power switch of the main body is off and the power cable is off.
- 2** Remove the fuse holder by rotating it counterclockwise by a screwdriver.

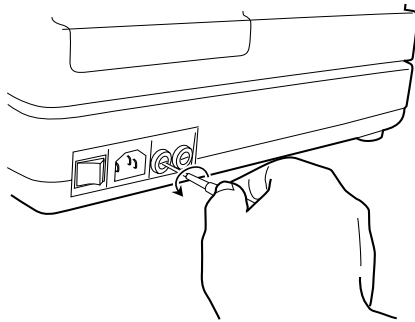

- 3** Replace the fuse with the attached one.

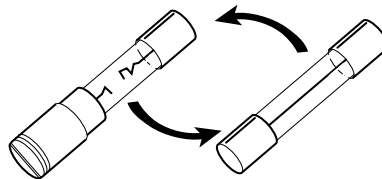

Changing the fuse

- 4** After inserting, rotate the fuse holder clockwise by a screwdriver while pushing it lightly.

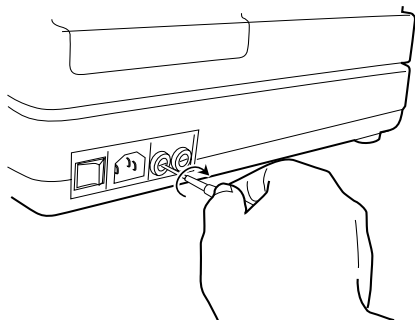

## **MAINTENANCE**

### **CLEANING THE DUST COVER**

<b>NOTICE</b>	<ul style="list-style-type: none"><li>• Avoid cleaning plastic parts with solvents. Benzine, thinner, ether an gasoline may cause discoloring and decomposition.</li></ul>
---------------	--

- 1** If the dust cover, control panel, etc. get soiled, wipe the surface with dry cloth.
- 2** If the dust cover is noticeably stained, wipe the surface with a cloth which is moistened in a tepid water solution of neutral detergent for food and then squeezed out.

### **USER MAINTENANCE**

To maintain the safety and performance of the instrument, unless performed by an authorized service engineer, never attempt to perform maintenance of items other than those specified herein.

For details about maintenance, read the description of this manual.

---

When calling please have ready the following information about your unit:

- Machine type: RM-8800, KR-8800
- Manufacturing No. (Shown on the rating plate on the right side of the base.)
- Period of Usage (Please give us the date of purchase).
- Description of Problem (as detailed as possible).

---

AUTO REFRACTOMETER RM-8800  
AUTO KERATO-REFRACTOMETER KR-8800

INSTRUCTION MANUAL  
Version of 2004 (2004.3-100TH0)  
Date of issue: 31th, March, 2004

Published by TOPCON CORPORATION

75-1 Hasunuma-cho, Itabashi-ku, Tokyo, 174-8580 Japan.

---

©2004 TOPCON CORPORATION  
ALL RIGHTS RESERVED

AUTO REFRACTOMETER

**RM-8800**

AUTO KERATO-REFRACTOMETER

**KR-8800**

**TOPCON MEDICAL SYSTEMS, INC**

37 West Century Road, Paramus, New Jersey 07652, U.S.A. Phone: 201-261-9450 Fax: 201-387-2710 www.topcon.com

**TOPCON CANADA INC.**

110 Provencher Avenue, Boisbriand, QC J7G 1N1 CANADA Phone: 450-430-7771 Fax: 450-430-6457 www.topcon.ca

**TOPCON EUROPE B.V.**

(European Representative)

Essebaan 11, 2908 LJ Capelle a/d IJssel, THE NETHERLANDS Phone: 010-4585077 Fax: 010-4585045 www.topconeuropa.com

**ITALY OFFICE:** Via Monfalcone 39, 20092 Cinisello B. mo (MI) ITALY Phone: 02-61-25-583 Fax: 02-61-25-927

**TOPCON DEUTSCHLAND G.m.b.H.**

Giesslerallee 31-33 D-47877 Willich GERMANY Phone: 02154-8850 Fax: 02154-885111 www.topcon.de Med@topcon.de

**TOPCON ESPAÑA S.A.**

**HEAD OFFICE:** Frederic Mompou 5, ED. Euro 3, 08960, Sant Just Desvern Barcelona, SPAIN Phone: 93-4734057 Fax: 93-4733932 www.topconesp.com

**MADRID OFFICE:** Avenida Burgos, 16E, 1 ° 28036, Madrid, SPAIN Phone: 91-302-4129 Fax: 91-383-3890

**TOPCON S.A.R.L.**

89, rue de Paris 92585 Clichy, Cedex, FRANCE Phone: 01-4106-9494 Fax: 01-4739-0251

**TOPCON SCANDINAVIA A.B.**

Neongatan 2 S-43151 Molndal, SWEDEN Phone: 031-7109200 Fax: 031-7109249 info@topcon.se

**TOPCON ( GREAT BRITAIN ) LTD.**

Topcon House, Kennet Side, Bone Lane, Newbury, Berkshire RG14 5PX United Kingdom Phone: 01635-551120 Fax: 01635-551170

**TOPCON SOUTH ASIA PTE.LTD.**

Blk 192 Pandan Loop, #07-01 Pantech Industrial Complex, SINGAPORE 128381 Phone: 62780222 Fax: 62733540 www.topcon.com.sg

**TOPCON INSTRUMENTS ( MALAYSIA ) SDN.BHD.**

Excella Business Park Block C, 1st Floor, Jalan Ampang Putra, Taman Ampang Hillir, 55100 Kuala Lumpur, MALAYSIA Phone: 03-42701192 Fax: 03-42704508

**TOPCON INSTRUMENTS ( THAILAND ) CO.,LTD.**

77/162 Sinn Sathorn Tower, 37th Fl., Krungdhonburi Rd., Klongtong Sai, Klongsarn, Bangkok 10600, THAILAND Phone: 440-1152~7 Fax: 440-1158

**TOPCON AUSTRALIA PTY.LTD.**

408 Victoria Road, Gladesville, NSW 2111, AUSTRALIA Phone: 02-9817-4666 Fax: 02-9817-4654 www.topcon.com.au

**TOPCON KOREA CORPORATION**

2F Yooseoung Bldg., 1595-3, Seocho-Dong, Seocho-Gu, Seoul, 137-876 KOREA Phone: 02-2055-0321 Fax: 02-2055-0319 www.topcon.co.kr

**TOPCON OPTICAL ( H.K. ) LTD.**

2/F., Meeco Industrial Bldg., No. 53-55 Au Pui Wan Street, Fo Tan Road, Shatin, N.T., Hong Kong Phone: 2690-1328 Fax: 2690-2221 E-mail: sales@topcon.com.hk

**TOPCON CORPORATION BEIJING OFFICE**

Room No. 962 Poly Plaza Building, 14 Dongzhimen Nandajie Dongcheng District, Beijing, 100027, CHINA Phone: 10-6501-4191~2 Fax: 10-6501-4190

**TOPCON CORPORATION BEIRUT OFFICE**

P.O.Box 70-1002 Antelias, BEIRUT-LEBANON Phone: 961-4-523525/523526 Fax: 961-4-521119

**TOPCON CORPORATION DUBAI OFFICE**

C/O Atlas Medical FZCO., P.O.Box 54304 C-25, Dubai Airport Free Zone, UAE Phone: 971-4-2995900 Fax: 971-4-2995901

**TOPCON CORPORATION**

75-1 Hasunuma-cho, Itabashi-ku, Tokyo, 174-8580 Japan.  
Phone: 3-3558-2520 Fax: 3-3960-4214 www.topcon.co.jp

41840 45992  
Printed in Japan  
0403-100TH©