

Product data sheet

Specifications

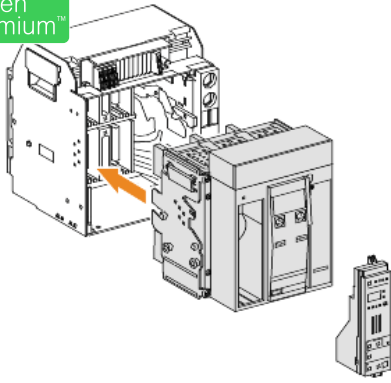

circuit breaker Masterpact NT08H2 - 800 A - 3 poles - drawout - w/o trip unit

47211

Main

Range of product	Masterpact NT
Product or component type	Basic frame
Device short name	Masterpact NT08
Circuit breaker name	Masterpact NT08H2
Poles description	3P
Network type	AC
Breaking capacity code	H2
Suitability for isolation	Yes conforming to IEC 60947-2
Utilisation category	Category B

Complementary

Network frequency	50/60 Hz
Control type	Push-button
Mounting mode	Drawout
[In] rated current	800 A at 40 °C
[Ui] rated insulation voltage	1000 V AC 50/60 Hz conforming to IEC 60947-2
[Uimp] rated impulse withstand voltage	12 kV conforming to IEC 60947-2
[Icm] rated short-circuit making capacity	88 kA 525 V AC at 50/60 Hz 88 kA 690 V AC at 50/60 Hz 105 kA 220/415 V AC at 50/60 Hz 105 kA 440 V AC at 50/60 Hz
[Ue] rated operational voltage	690 V AC 50/60 Hz conforming to IEC 60947-2
Circuit breaker CT rating	800 A
Breaking capacity	42 kA Icu at 525 V AC 50/60 Hz conforming to IEC 60947-2 42 kA Icu at 690 V AC 50/60 Hz conforming to IEC 60947-2 50 kA Icu at 440 V AC 50/60 Hz conforming to IEC 60947-2 50 kA Icu at 220...240 V AC 50/60 Hz conforming to IEC 60947-2 50 kA Icu at 380...415 V AC 50/60 Hz conforming to IEC 60947-2
[Ics] rated service breaking capacity	42 kA at 525 V AC 50/60 Hz conforming to IEC 60947-2 42 kA at 690 V AC 50/60 Hz conforming to IEC 60947-2 50 kA at 440 V AC 50/60 Hz conforming to IEC 60947-2 50 kA at 220/415 V AC 50/60 Hz conforming to IEC 60947-2
Protection type	Without protection
Mechanical durability	12500 cycles without maintenance conforming to IEC 60947-2

Electrical durability	3000 cycles 690 V AC 50/60 Hz without maintenance conforming to IEC 60947-2 6000 cycles 440 V AC 50/60 Hz without maintenance conforming to IEC 60947-2 AC-23A: 3000 cycles 690 V AC 50/60 Hz without maintenance conforming to IEC 60947-2 AC-23A: 6000 cycles 440 V AC 50/60 Hz without maintenance conforming to IEC 60947-2 AC-3: 6000 cycles 440 V AC 50/60 Hz without maintenance conforming to IEC 60947-2
Connection pitch	70 mm
[Icw] rated short-time withstand current	20 kA 3 s conforming to IEC 60947-2 42 kA 0.5 s conforming to IEC 60947-2 42 kA 1 s conforming to IEC 60947-2
Integral instant protection	81...99 kA
Maximum breaking time	25 ms
Maximum closing response time	50 ms
Height	322 mm
Width	288 mm
Depth	276.5 mm

Environment

Standards	IEC 60947-2
Product certifications	LCIE ASEFA
Pollution degree	3 conforming to IEC 60664-1
Ambient air temperature for operation	-25...70 °C
Ambient air temperature for storage	-40...85 °C

Packing Units

Unit Type of Package 1	PCE
Number of Units in Package 1	1
Package 1 Weight	23.068 kg
Package 1 Height	25 cm
Package 1 width	40 cm
Package 1 Length	40 cm

Offer Sustainability

Sustainable offer status	Green Premium product
REACH Regulation	REACH Declaration
EU RoHS Directive	Compliant EU RoHS Declaration
Mercury free	Yes
RoHS exemption information	Yes
China RoHS Regulation	China RoHS declaration Product out of China RoHS scope. Substance declaration for your information
Environmental Disclosure	Product Environmental Profile
Circularity Profile	End of Life Information
PVC free	Yes
California proposition 65	WARNING: This product can expose you to chemicals including: DINP, which is known to the State of California to cause cancer, and DIDP, which is known to the State of California to cause birth defects or other reproductive harm. For more information go to www.P65Warnings.ca.gov

Contractual warranty

Warranty

18 months