

DRM270220LT**Weidmüller Interface GmbH & Co. KG**

Klingenbergstraße 26

D-32758 Detmold

Germany

www.weidmueller.com

Product image

Similar to illustration

Individual relays within the D-SERIES DRM

- 2 CO contacts
- AC coils
- With integrated status LED and test button

General ordering data

Version	D-SERIES DRM, Relay, Number of contacts: 2, CO contact, AgNi flash gold-plated, Rated control voltage: 220 V DC, Continuous current: 10 A, Plug-in connection
Order No.	7760056072
Type	DRM270220LT
GTIN (EAN)	4032248855834
Qty.	20 pc(s).

Creation date January 9, 2022 11:45:01 AM CET

Catalogue status 17.12.2021 / We reserve the right to make technical changes.

DRM270220LT

Weidmüller Interface GmbH & Co. KG

Klingenbergstraße 26

D-32758 Detmold

Germany

www.weidmueller.com

Technical data

Dimensions and weights

Depth	35.7 mm	Depth (inches)	1.406 inch
Height	27.4 mm	Height (inches)	1.079 inch
Width	21 mm	Width (inches)	0.827 inch
Net weight	30.9 g		

Temperatures

Storage temperature	-40 °C...70 °C	Operating temperature	-40 °C...60 °C
Humidity	35...85 % rel. humidity, no condensation		

Environmental Product Compliance

REACH SVHC	Lead 7439-92-1
------------	----------------

Rated data UL

Certificate No. (cURus)	E312083
-------------------------	---------

Control side

Rated control voltage	220 V DC	Rated current DC	5.2 mA
Power rating	1.2 W	Pull-in/drop-out voltage, typ.	165 V / 22 V DC
Coil resistance	44000 Ω ± 10 %	Status indicator	Green LED

Load side

Rated switching voltage	250 V AC	Continuous current	10 A
Max. switching frequency at rated load	0.1 Hz	Min. switching power	10 mA @ 12 V, 100 mA @ 5 V
Inrush current	20 A / 50 ms	AC switching capacity (resistive), max.	2500 VA
DC switching capacity (resistive), max.	240 W @ 24 V	Switch-on delay	≤ 20 ms
Switch-off delay	≤ 20 ms	Contact type	2 CO contact (AgNi flash gold-plated)
Mechanical service life	20 x 10 ⁶ switching cycles		

General data

Test button available	Yes		
Mechanical switch position indicator	Yes		
Colour	Transparent		
UL94 flammability rating component	Component	Relay cover	
	UL94 flammability rating	V-2	
	Component	Relay baseplate	
	UL94 flammability rating	V-0	
	Component	Relay status indicator	
	UL94 flammability rating	HB	
	Component	Relay test button	
	UL94 flammability rating	HB	

DRM270220LT

Weidmüller Interface GmbH & Co. KG

Klingenbergstraße 26

D-32758 Detmold

Germany

www.weidmueller.com

Technical data

Insulation coordination

Rated voltage	250 V	Pollution severity	2
Surge voltage category	III	Clearance and creepage distances for control side - load side	≥ 5.5 mm
Dielectric strength for control side - load side	1.8 kV _{eff} / 1 min.	Dielectric strength of neighbouring contacts	1 kV _{eff} / 1 min
Dielectric strength of open contact	1 kV _{eff} / 1 min	Impulse withstand voltage	6 kV (1.2/50 μs)
Protection degree	IP20		

Further details of approvals / standards

Standards	IEC 61810-1, EN 60664-1:2007, EN 61000-6-2:2005, EN 61000-6-4:2007 + A1:2011, UL 508	Certificate No. (cURus)	E312083
-----------	--	-------------------------	---------

Connection data

Wire connection method	Plug-in connection
------------------------	--------------------

Classifications

ETIM 6.0	EC001437	ETIM 7.0	EC001437
ETIM 8.0	EC001437	ECLASS 9.0	27-37-16-01
ECLASS 9.1	27-37-16-01	ECLASS 10.0	27-37-16-01
ECLASS 11.0	27-37-16-01		

Approvals

Approvals



ROHS	Conform
UL File Number Search	E312083

Downloads

Approval/Certificate/Document of Conformity	EU Konformitätserklärung / EU Declaration of Conformity
Engineering Data	CAD data – STEP
Engineering Data	EPLAN, WSCAD
Catalogues	Catalogues in PDF-format
Brochures	

DRM270220LT

Weidmüller Interface GmbH & Co. KG
 Klingenbergstraße 26
 D-32758 Detmold
 Germany

www.weidmueller.com

Drawings

Wiring diagram

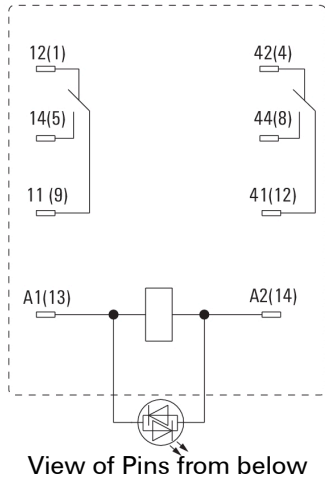

Graph

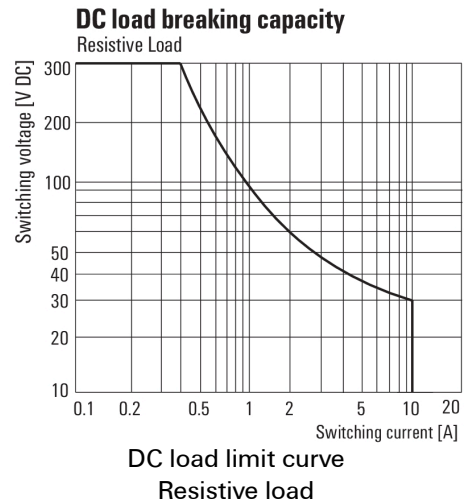

Graph

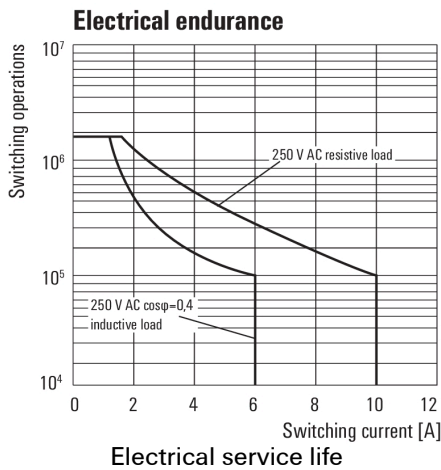

Graph

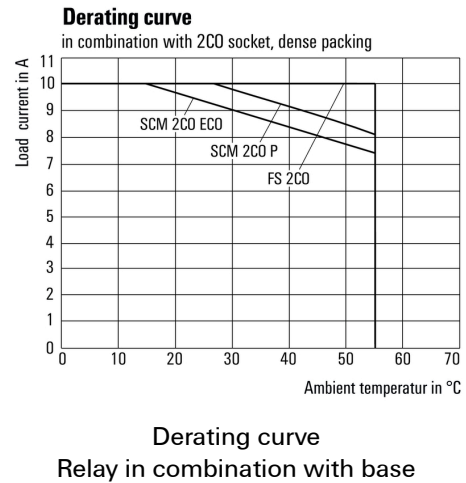

Graph

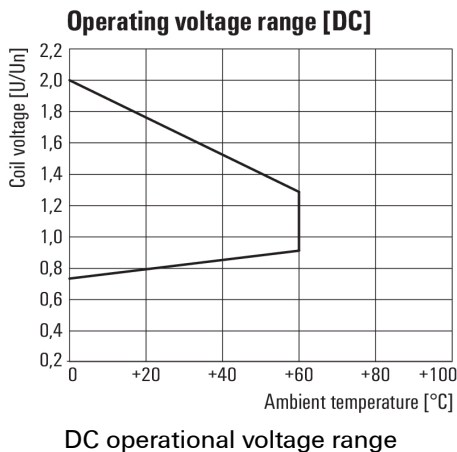

Dimensional drawing

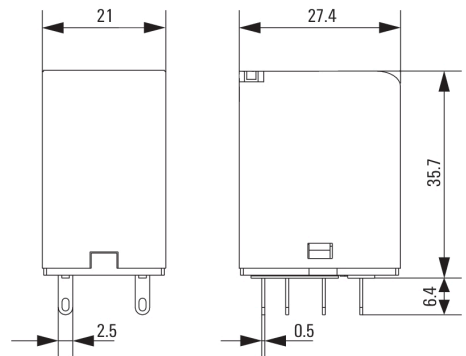

DRM270220LT

Weidmüller Interface GmbH & Co. KG
 Klingenbergstraße 26
 D-32758 Detmold
 Germany

www.weidmueller.com

Drawings

Miscellaneous

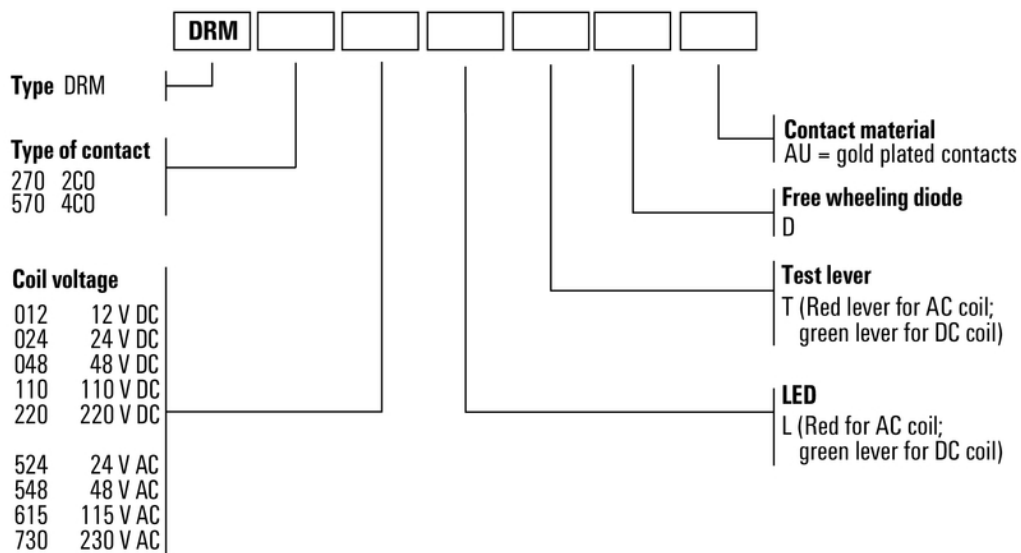

Type codes