



Powerology Portable Power

Generator Fast Charging 384Wh 600W

SKU: PPBCHA39

 **Table of content**

Instructions for Use and Maintenance	2
Product Charging Instructions	5
Product Storage and Shipping	6
Battery Disposal	7
Maintenance	8
Boarding Precautions	8
Package Contents	8
Schematic View of the Power Generator	8
Display Interface	12
Guide for Port Operation Indicators	14
Error Diagnostics and Causes	15
Connecting to Solar Panel	11
Specifications	17
Charging the Power Generator	19
App Connectivity	19
Warranty	25
Contact Us	25

Instructions for Use, Safety, and Maintenance

Before using the product, please carefully read this User Manual to guarantee correct usage and keep it secure for future reference.

Notice

To power the device ON or OFF, press and hold the ON/OFF key. To activate the AC output power socket, press and hold the AC ON/OFF power button once the device is ON. This design ensures the conservation of battery power, allowing the portable power generator's energy to be reserved for emergencies. Before using the product for the first time, it is advisable to fully charge the device to 100 %.

Glossary

The following entries describe the levels of danger associated with improper operation.

1. Notice

Not adhering to instructions may reduce product performance and result in minor product damage.

2. Caution

Ignoring instructions could compromise product performance and cause significant damage to the product.

3. Warning

Thoroughly read the user manual before using the product and familiarize yourself with its functions before starting. In the event of injury, product damage, or property loss due to improper operation, our company will not assume legal responsibility. Avoid using parts not supplied or recommended by our company. Adherence to our company's guidelines for installation and usage is imperative to retain eligibility for after-sales service. This document includes

important safety, operation, and maintenance instructions. Ensure you consult the owner's manual thoroughly before assembly, setup, and use.

Product Safety Guideline Warnings Improper use of this product may lead to fire, damage to property, or personal injury. Ensure compliance with the following safety guidelines when using the product.

Caution

- 1.** Ensure the item remains dry and avoid exposure to high temperatures.
- 2.** Do not disassemble, puncture, subject to shock, crush, create a short circuit, or incinerate.
- 3.** Recycle and dispose of the item in compliance with local regulations.

Product Disclaimer

Carefully review all safety notices, warning messages, terms of use, and disclaimers. Before utilizing the product, refer to the terms of use and disclaimer information on the product label. The user bears full responsibility for all aspects of product use and operation. The user must become acquainted with the applicable regulations in their area and employ our products in a manner that is consistent with all relevant regulations.

Product Use Guidelines

- 1.** Avoid any contact between the product and liquids; do not submerge in water or expose it to moisture. Refrain from using the device in rainy conditions or environments with high humidity, as this may cause the battery to ignite or even explode.

- 2.** The use of unauthorized components is strictly prohibited. Should you require a replacement, please consult our official website for legitimate purchase options. Our company disclaims responsibility for any accidents or malfunctions resulting from the use of components not supplied by us.
- 3.** Ensure that the power is turned off before installing or removing any modules of the machine. Never insert or disconnect modules or components while the machine is powered on, as this could result in damage to the power interface.
- 4.** Operating the device at an ambient temperature exceeding 60°C (140°F) is unsafe as it may lead to the battery igniting or exploding. Conversely, if the ambient temperature falls below -20°C (-4°F), the device's performance will degrade significantly, failing to meet standard operational requirements. However, once the device is returned to a normal temperature range, it should resume functioning as expected.
- 5.** The device must not be operated within environments where strong static electricity or magnetic fields are present, as this could interfere with its performance. In such conditions, the device's protective functions may be compromised, potentially resulting in a severe malfunction.
- 6.** Disassembling or puncturing the device with any sharp objects is strictly prohibited. Such actions can lead to product failure, and in some cases, may result in a fire or explosion.
- 7.** Do not use the device if it has been dropped or subjected to an external force. Any impact may compromise the device's integrity.
- 8.** If the product is inadvertently submerged in water, remove it promptly and place it in a secure location to dry thoroughly. It is

imperative that the product is not used after drying and that it is disposed of in a manner consistent with the guidelines outlined herein. Should the product ignite, extinguish the flames in the following sequence, if applicable: water or water mist, sand, fire blanket, dry powder, or carbon dioxide fire extinguisher.

9. Never place the machine inside a microwave or pressure cooker.

10. Avoid causing a short circuit by connecting the product with wires or any other metal objects.

11. Refrain from hitting the machine or placing any heavy objects atop it.

12. Should any dirt accumulate on the machine's interface, clean it with a dry cloth to prevent any loss of energy or charging issues.

Product Charging Instructions

1. The machine must only be charged using the charging cable that our company has officially approved. We shall not be held accountable for any consequences resulting from the use of non-approved charging cables.

2. When charging, position the machine on a non-flammable surface, away from any materials that could catch fire. Remain vigilant and monitor the machine during the charging process to prevent any mishaps.

3. After the machine has been discharged fully, its battery may be hot. Allow the machine to return to room temperature before initiating recharging. Using AC charging cables from other product lines to charge this product is prohibited. Our company disclaims all legal responsibility for damage or loss incurred if the user does not

adhere to the instructions provided in this manual.

4. For optimal performance, please operate the portable power generator within the specified product usage and storage temperature ranges. Utilizing the portable power generator outside these parameters may compromise its safety and efficiency.

5. Over-temperature protection is expected to activate when the 600W heating appliance is used for durations exceeding half an hour. After such use, it is advisable to allow the device to cool for approximately one hour before proceeding with further use or charging.

Product Storage and Shipping

1. Before storage, turn off the power generator by pressing the ON /OFF main power button.

2. Ensure the machine is stored in a location inaccessible to children. In the event a child ingests any part of the machine, seek medical assistance immediately.

3. If an indication is given that the battery level is critically low after usage, it is essential to charge the battery before storing it.

Neglecting to do so could result in long-term damage to the battery. A battery that remains at a low charge for an extended period may enter a deep sleep state; if this occurs, it must be recharged to reactivate it.

4. Place the device within the recommended temperature range for product storage. The product must not be placed near any source of heat, such as inside a hot vehicle, near open flames, or close to cooking appliances.

5. The storage environment for the machine should be dry and free from moisture exposure. Do not immerse the machine in water or expose it to conditions where it could become wet.
6. Refrain from storing or transporting the product with items such as eyeglasses, watches, metal necklaces, hairpins, or any metal objects that could potentially cause interference or damage.
7. When using express delivery services or logistics to transport the machine, ensure the battery level is reduced to below 30 % before shipping.
8. To extend the battery life during prolonged storage periods, it is advised to cycle the battery every three months: first, discharge the battery to %30, and then recharge it to 85 %.
9. The recommended ambient temperature for operating or storing the battery is between -20°C to 45°C . Ideally, the battery should be kept in conditions where the ambient temperature is between 20°C to 25°C .
10. Extended periods of inactivity may adversely affect the device's performance.

Battery Disposal

1. Prior to disposing of the machine's battery, it is imperative to deplete its charge completely. Place the fully discharged battery into the appropriate battery recycling container. Batteries contain hazardous substances and should never be discarded with regular waste. Follow all local regulations regarding battery recycling and disposal.
2. If the battery fails to power up after being deeply discharged, it must be treated as waste material and disposed of responsibly.

Maintenance

The portable power generator is a versatile device and routine light cleaning should be performed, occasionally.

1. For regular maintenance, please use a dry, non-abrasive cloth. If a more thorough cleaning is required, we recommend using a special cleaner designed for mobile phones or computer screens.
2. It is important to avoid exposing the product to water.

Boarding Precautions

This machine is not permitted for transport on board an aircraft.

Package Contents



Power generator unit

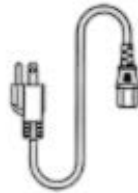

AC charging cable

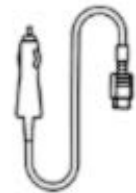

Car charger cable

Schematic View of the Power Generator

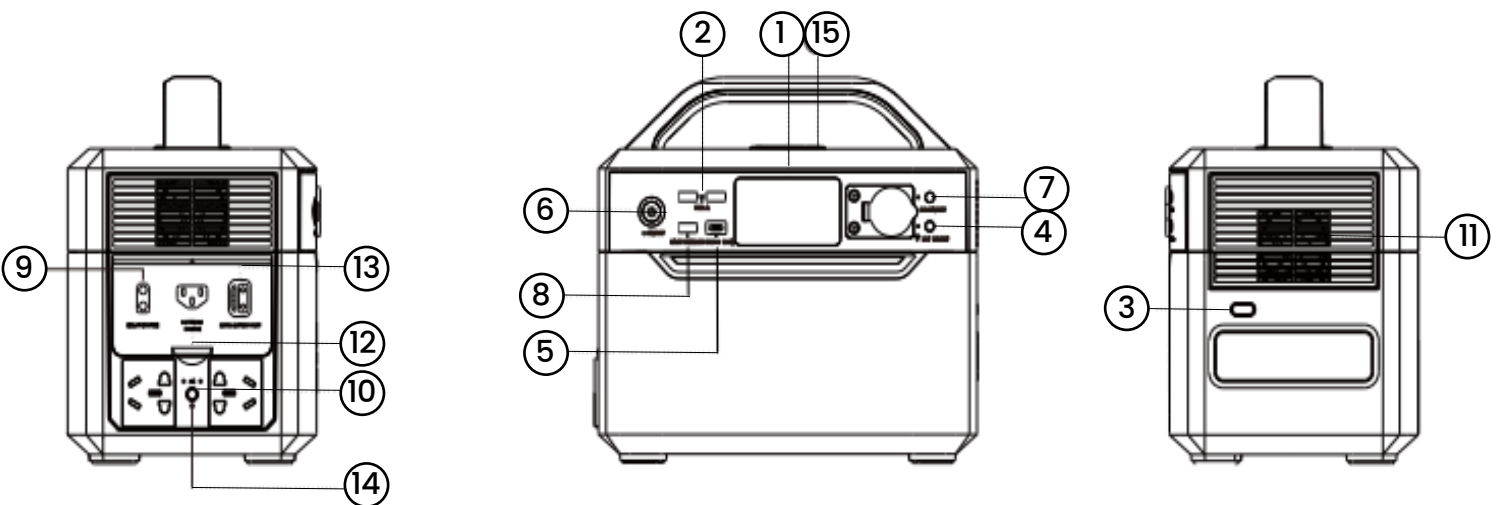

① LCD Screen	⑧ Fast Charging USB-A Port
② USB-A Port	⑨ AC Output Power Key and AC Output Indicator Light
③ Control Buttons for LED Lights	⑩ AC Output Sockets
④ IoT Reset Switch	⑪ Ventilation and Cooling Holes
⑤ Fast Charging 100W Type-C Output Port	⑫ X-Stream Charging Input Port
⑥ Power Button and LCD Display Switch Power Indicator Light	⑬ Solar Panel Charging/Car Charging Input Port
⑦ DC Output Port Switch and DC Output Indicator Light	⑭ Wireless Charging Indicator Port

1. LCD Screen

Displays the power status and usage of the product.

2. USB-A Port

Facilitates the charging of smartphones, tablets, GoPros, speakers, and other devices compatible with a USB-A port. The monitor's USB-A output indicator will illuminate upon activation.

3. Control Buttons for LED Lights

The LED light features dual intensity settings: a dim light mode and a bright light mode. A single press activates the dim mode, a subsequent press initiates the bright mode, and a final press reverts to the dim mode. An extended press will switch the LED off. Maintaining pressure on the ambient light button for three seconds cycles through seven colors, displaying a 3-color gradient and a 7-color gradient sequence.

4. IoT Reset Switch

This function allows for the resetting of the Wi-Fi connection.

Press and Hold for 3 Seconds to Reset the Wi-Fi.

5. Fast Charging 100W Type-C Output Port

The USB-C port provides fast charging for devices, including but not limited to the MacBook Pro, Android phones, and other electronics that utilize a USB Type-C connection. When a device is connected, the USB Type-C output indicator will automatically become visible.

6. Power Button and LCD Display Switch Power Indicator Light

To activate the device, press and hold the power button.

Subsequent long presses will deactivate the device. When powered on, the power indicator emits a pulsating light while the screen remains active. If the product detects activity, such as the connection or disconnection of devices, or interaction with buttons, the screen's backlight will engage. In the absence of any operation, the device's display will automatically power down after two minutes. However, the device continues to function on battery power. If the default idle state surpasses two hours, the power generator will power off. The LCD's automatic time-off and idle time can be modified and set through the "Smartlife" App. Short -press the power button to activate the PD button.

7. DC Output Port Switch

Activate the car charger output port (comprising port 2 and DC5521 output ports) by a short press. The corresponding DC output indicator will light up to signal activation.

8. Fast Charging USB-A Port

When a device is plugged into the USB-A port, the fast-charging function will be indicated by the illumination of the USB-A output icon on the display. Devices that are compatible with fast charging can charge at maximum power of 60W. If fast charging is not supported by the device, it will charge the device at the standard rate.

9. AC Output Power Key and AC Output Indicator Light

The AC output is controlled by the AC power key, which needs to be turned on manually. To commence the supply of AC power, press and hold the AC power key. If the AC power is not required for Disconnect the power cord from the AC output socket if the AC power will not be used. The AC light will be visible when the device's AC power is on. If the AC power output remains unused for a duration exceeding 12 hours, the system will automatically disconnect from the AC power source.

10. AC Output Sockets

The device accommodates appliances that operate on either 110V or 220V power, such as laptops, TVs, refrigerators, and vacuum cleaners. It features an internal inverter with a capacity to power devices rated between 600W to 650W. While it cannot support exceedingly power-intensive appliances, it is suitable for a range of common electronics and appliances. However, it is advisable to verify compatibility to prevent any disruption to your work or damage to the device. It is not recommended for use with high-power home appliances such as air conditioners, coffee machines, clothes dryers, electric stoves, refrigerators, microwaves, lawnmowers, electric ovens, or washing machines.

11. Ventilation and Cooling Holes

These features are designed to prevent the power generator from overheating. It is important to ensure that these vents are not obstructed to maintain proper thermal regulation.

12. X-Stream Charging Input Port

For AC charging, insert the AC charging cable into this port and then connect it to an AC power source. This port is designed to support 220Vac-240Vac (50Hz/60Hz) charging.

13. Solar Panel Charging/Car Charging Input Port

The power generator is compatible with solar panels up to 110W and supports a maximum solar input of 18.5-10V, 110W, 8A. It can also accommodate a 12V car battery with a maximum of 8A. When utilizing the car charger to charge the power generator, refrain from using the car charger to power other devices simultaneously. However, the power generator can still be used as a power supply for your devices.

14. Wireless Charging Indicator Port

This port is equipped with an indicator to signify active wireless charging.

Display Interface

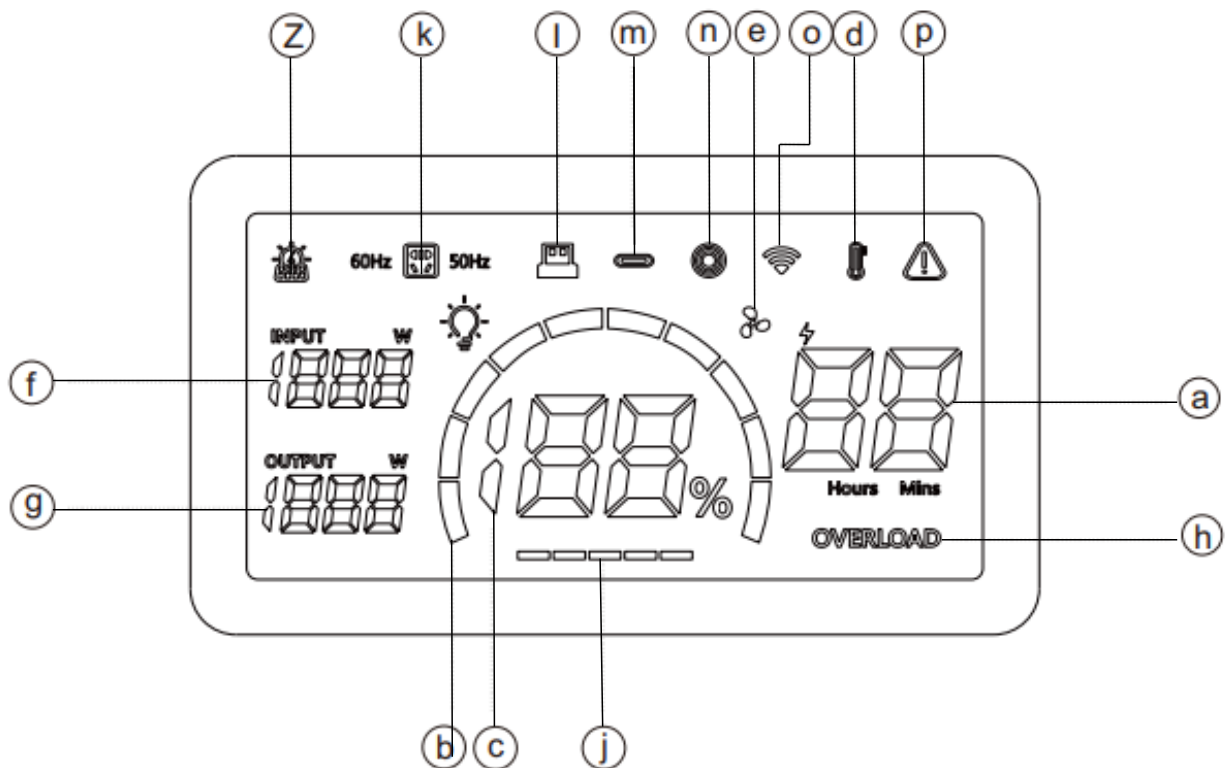

a. Remaining Charge/Discharge Time

The power generator estimates the remaining time for charging or discharging based on current power usage, providing a minute -accurate assessment.

b. Battery Level Indicator

The battery level indicator displays the current battery level. While charging, the power icon becomes animated. Should the battery power fall below 5 %, a blinking warning signal is activated at a rate of one blink per second, indicating low battery status – a situation rectifiable by charging.

c. Battery Percentage

The display indicates the percentage of battery remaining. If the battery level reaches 5 %, it is advised to start charging the device immediately.

d. Temperature Indicator

Should the power generator's internal temperature exceed or drop below optimal levels, a temperature warning icon is displayed, prompting the user to either cool down or warm up the machine accordingly.

e. Fan Indicator

The power generator automatically adjusts the fan speed, which is displayed on the LCD, correlating the displayed speed with the actual fan speed.

f. Input Power

This feature shows the real-time input power to the power generator, measured in watts.

g. Output Power

This displays the real-time output power from the power generator, measured in watts.

h. Overload Warning

The power generator is equipped with an overload protection system. If an overload is detected, icons and indicators specific to the affected module will alert the user to the exact overload condition.

Guide for Port Operation Indicators

j. Power Connection Indicator

When the power generator is connected to a console, the corresponding power icon will be displayed to indicate connectivity.

k. AC Output 60Hz 50Hz

Upon activation of the AC output, the AC output icon will become visible as a confirmation of its operational status.

i. USB Type-A Output

Engaging the USB-A port will result in the illumination of the USB-A output icon, signaling its active state.

m. USB Type-C Output

Similarly, when the USB-C port is utilized, the USB-C output icon will be displayed, denoting its use.

n. Car Charger Output

Connecting a device to the car charger outlet will trigger the display of a bright icon, indicating the outlet is in use.

o. IoT Connection





Successful connection of the machine to the Internet is confirmed by the display of the IOT icon.





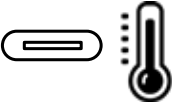

p. Error / Warning

In the event of abnormal operation of the device, a specific indicator will be displayed to alert the user.

Error Diagnostics and Causes

The power generator's display indicates the reasons for activating equipment protection by showcasing various icons and their combinations.

Icon	Description	Instructions
 OVERLOAD	USB Type-A and overload icons	When the USB-A icon and the OVERLOAD icon illuminate simultaneously, it indicates an overload condition. Once the electrical appliance causing the overload is disconnected, the system will automatically resume normal operation after a 10-second pause.
	USB Type-C and temperature protection icon	Should the Type-C icon and the temperature icon appear simultaneously, it denotes a temperature issue. Normal operation will automatically recommence after the unit has sufficiently cooled down.
 OVERLOAD	USB Type-C and overload icons	In the event the Type-C icon and the OVERLOAD icon are flashing together, this signals an overload with a connected USB-C device. After removing the offending device, the system will restore function automatically following a 10-second interval.
	Battery charging and temperature protection icon	If the charging icon and the temperature icon are blinking at the same time, this is an alert that the system is overheating. Please allow the device to cool before attempting to use it again.
 OVERLOAD	Battery charging and overload icons	If both icons are flashing together, you should unplug the device, restart it, and then reconnect it.

 OVERLOAD	Communication Failure between the Main Control Board and BMS	If the error icon is flashing, please restart the device.
	Inverter Output Overload	When the two icons flash, it signals that the device will reset after you restart it and a 10-second pause. Ensure that the electrical appliance is within the rated power. If the icon keeps flashing, please stop using the device for power supply and device charging.
	Inverter Over Temperature Protection	Should the two icons flash, turn off the AC switch, and allow the inverter to cool, after which, the inverter will resume functioning.
	Clogged Fan	If the fan icon is flashing, inspect the fan for any foreign objects. If an object is obstructing the motion of the fan, power off the device before removing the foreign object.
 OVERLOAD	Car Charger Overload	In the case that both the car charger and overload icons flash for 10 seconds, reset the DC switch to restore functionality, and ensure that the connected electrical appliances are within the rated power.
	Car Charger Temperature Protection	When the two icons are flashing, cease usage until the interface has sufficiently cooled down. Normal operation can be resumed post-cooling

1. To Charge a Solar Panel

The power generator supports the connection of one or two solar panels to the device and is designed to accept a DC input ranging from 15V to 22V. If the input exceeds 24V, the power generator's overvoltage protection will activate to prevent the device from getting damaged. To avoid harming the product, please adhere strictly to these guidelines. Please adhere to instructions regarding the number of connections and specifications of the compatible devices.

2. Charging the Power Generator

To charge the power generator using solar power, commence by connecting a single solar panel (note that a series connection is not supported) to the XT60 solar charging cable. Following this, attach the XT60 connector from the solar charging cable to the XT60 interface on the power generator. It is also feasible to link up to two solar panels in parallel. If you wish to connect a pair of solar panels, join them in parallel with a connection cable, then proceed to connect the XT60 solar charging cable, and finally plug the XT60 connector of the solar charging cable into the power generator's XT60 interface to initiate charging. Be aware that the parallel connection cable is not included in the standard configuration and must be acquired separately by the user.

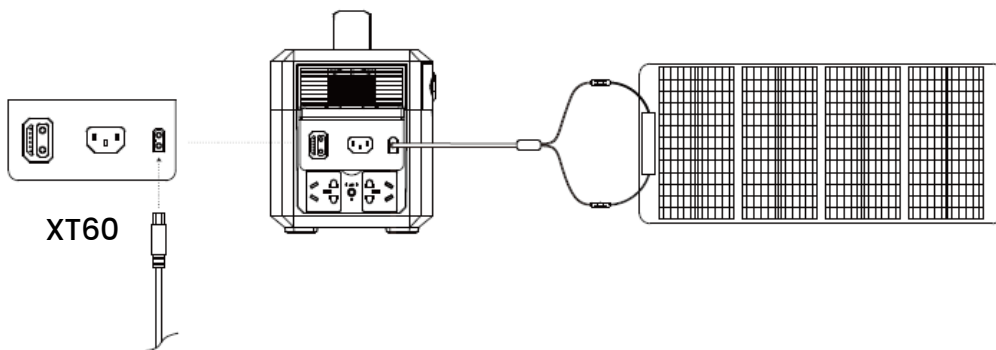

Specifications

General Parameters	
Net. Weight	6.5kg
Size	240×173.8×265.7mm
Capacity	384Wh
Certifications / Specifications	CE - FCC - ROHS - PSE

Input Parameters	
AC Charging Input Power	150W
AC Charging Input Voltage	240 - 200V
Solar Charging Input	100W / 18.5V / 6A (×2)
Car Charger	12.6V/8A

Output	
AC Output (×2)	600W (Max. 650W)
USB Type-A Output (×2)	Max. 5V/3A
USB Type-A Fast Charge (×1)	Port 60W
USB Type-C Output (×1)	Port 100W
Car Charger Outlet (×1)	100W / 8A / 12.6V
Wireless Output (×1)	15W

Battery	
Cell Type	Life p04
Cell Model	26700
Discharge Temperature	-4°F to 140°F (-20°C to 60°C)
Charging Temperature	32°F to 113°F (0°C to 45°C)
Shelf Life	1 year (After fully-charged)
Life Span	(80 %) +3000

Charging the Power Generator

Method 1

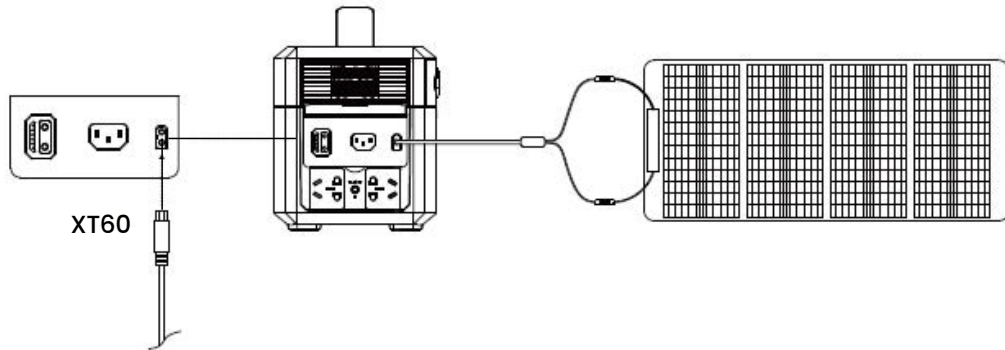

Method 2

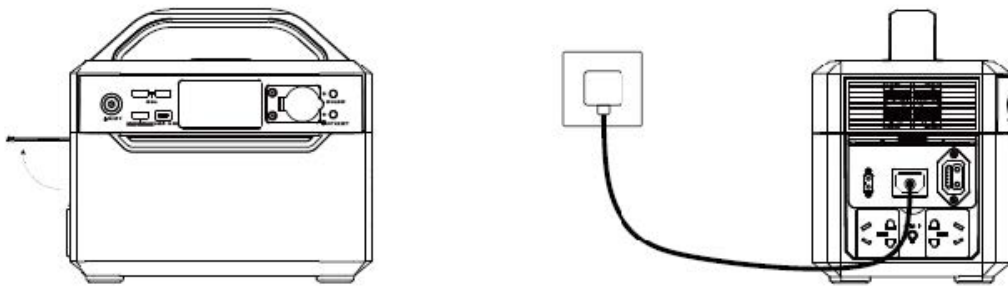

Method 3

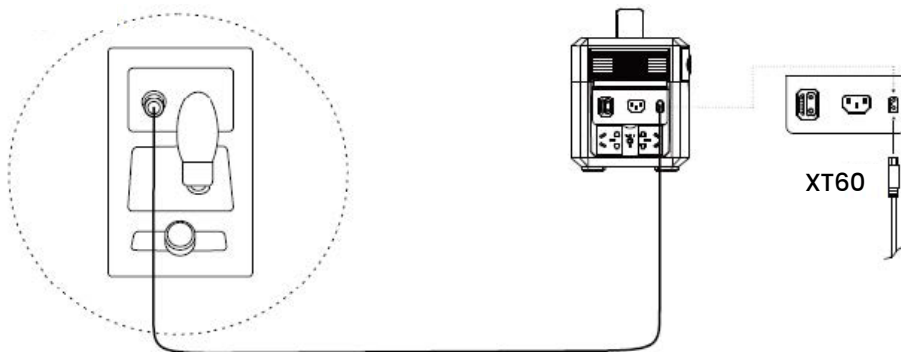

App Connectivity

1. Download and Installation

To download and install the App:

1.1 Search for the App name **"Smartlife"** in the App Store and Google Play.

1.2 Scan the provided QR code using your smartphone.



Android / IOS

2. Registration



1.2 Tap the Register icon to navigate to the account registration page.

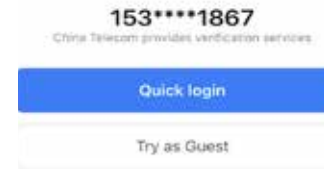

2.2 Registration can be completed using your email address or cell phone number, with the country/region defaulting to your cell phone system's settings. You have the option to manually adjust the country /region during the registration process; however, this cannot be altered once registration is finalized. To proceed, enter your cell phone number or email address and select 'Get Verification Code'.

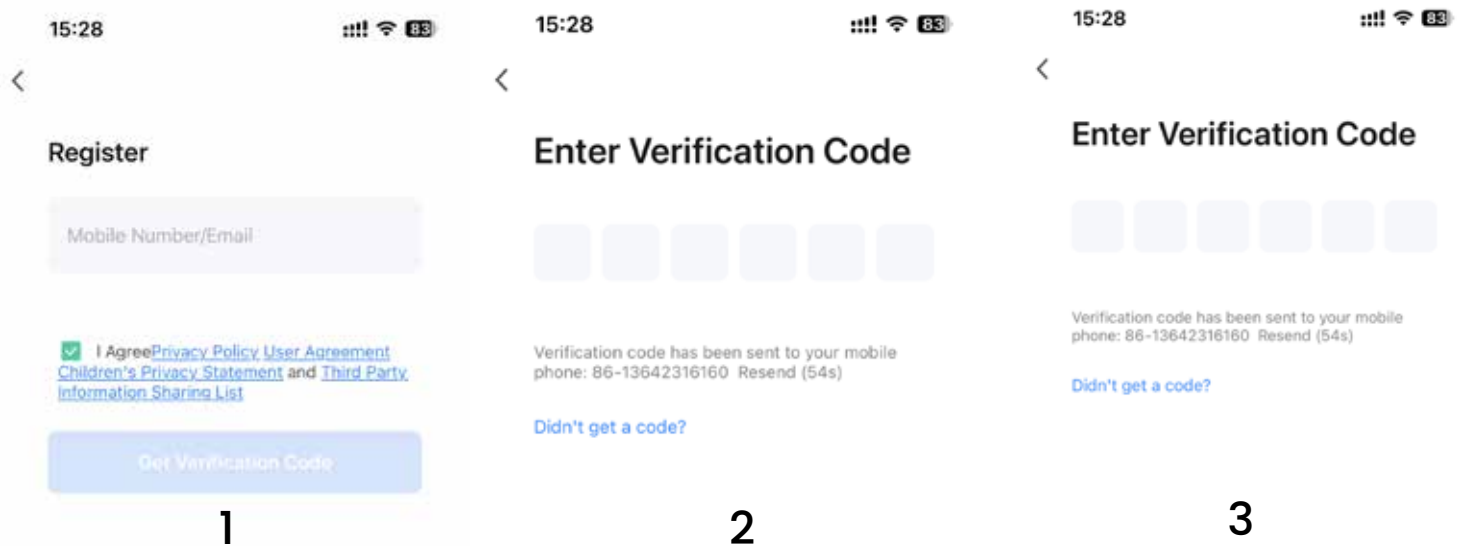

3. Login

3.1 If you possess an existing App account, select 'Sign in with an existing account' under the option to 'Create a new account' to navigate to the Sign-in page.

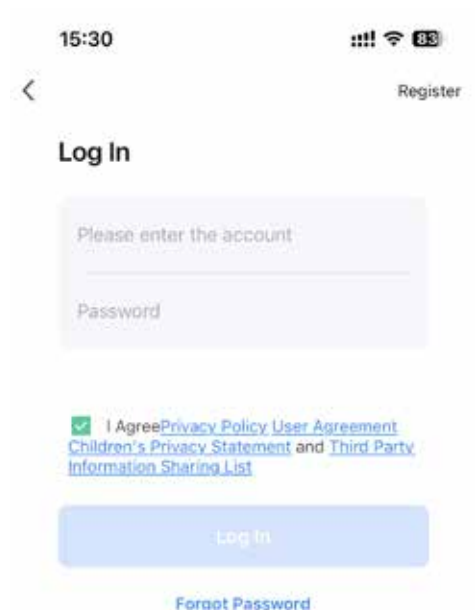

3.2 The system automatically identifies your current country, but you also have the option to manually select a different country if necessary.

3.3 To log in, enter the cell phone number or email address you provided during registration, followed by your password.

4. Adding Equipment

Begin by holding down the Wi-Fi on/off button on the mobile power unit until the Wi-Fi icon on the screen starts blinking, indicating it is ready to connect.



4.1 Connecting a Powered Device with Wi-Fi

Enable both Bluetooth and Wi-Fi features. Navigate to the "Enter Wi-Fi password" page. Only a 2.4GHz band Wi-Fi network is supported. You need to enable "Location" permission to connect to Wi-Fi, automatically.

Connecting for the First Time: Wi-Fi Setup Procedure



1

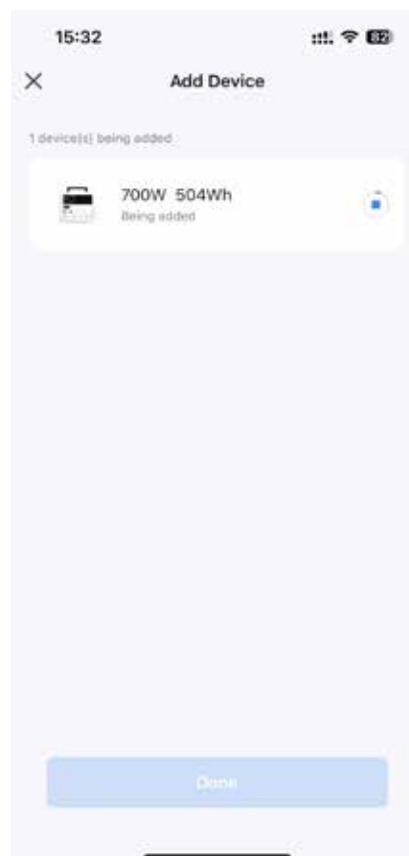

2



3

Select the option to connect your device. Once the connection is initiated, wait for the confirmation. Upon a successful connection, the mobile power unit will emit an audible “drop” sound.

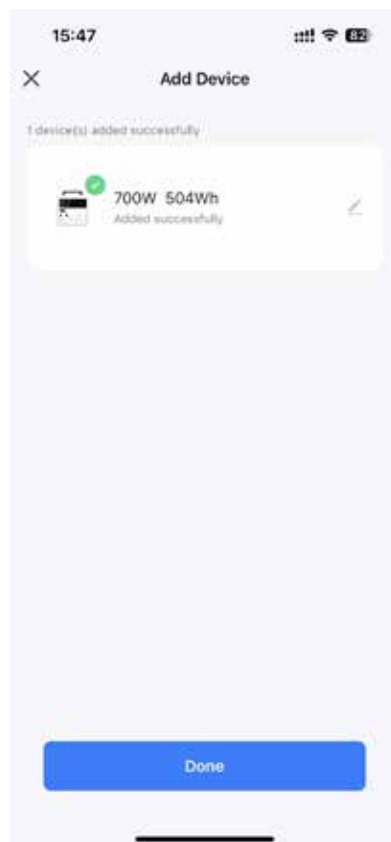

1



2

4.2 Connecting a Powered Device without Wi-Fi

Method 1

The user can utilize a Bluetooth connection to control the power supply as long as you don't reset the power IoT.

Method 2

Utilize the hotspot feature from an alternative cell phone to establish a connection. Press and hold the IoT button for an extended period to reset the Wi-Fi, and proceed with the connection steps. You may also control the power supply using the Bluetooth function.

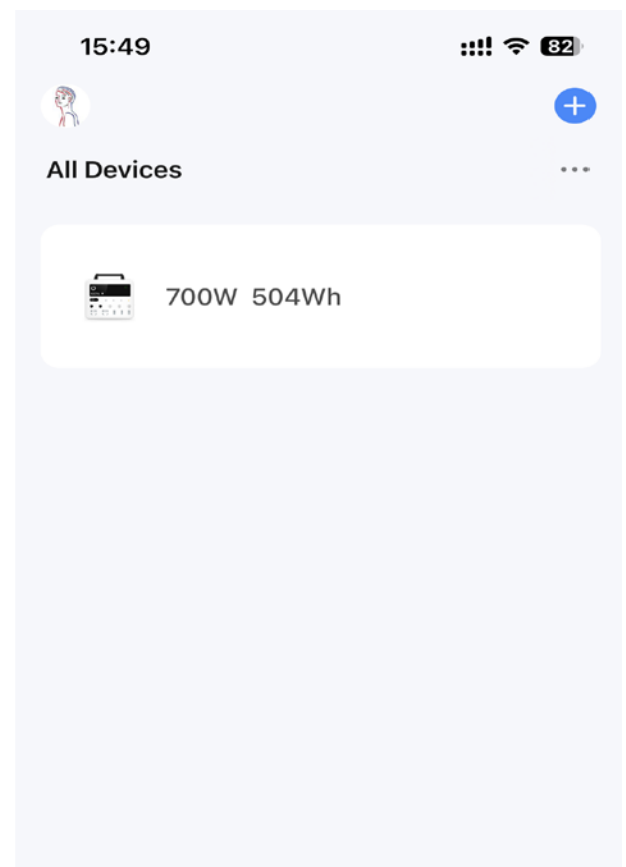

Step 1: Activate the hotspot feature on the smartphone. Enable "Allow Others to Join".

Step 2: Connect your smartphone hotspot.

Step 3: Reset the device via the IoT button.

Step 4: Utilize the "Smartlife" app to search for and add devices.



Step 1



Step 2



Step 3

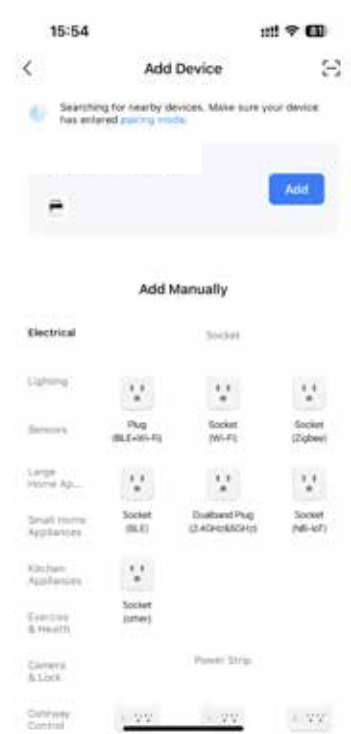

Step 4

5. Interface Description



Output Interface

AC Input Status Screen

Solar Input Status Screen

A. Power Level	F. DC Output Switch
B. AC Output Power	G. Lighting type switch
C. AC Output Switch	H. AC Input Power
D. AC Output Curve	I. AC Input Curve
E. USB and Wireless Charging Output Switch	J. Solar Input Power
	K. Solar Input Curve



Go to the Settings page

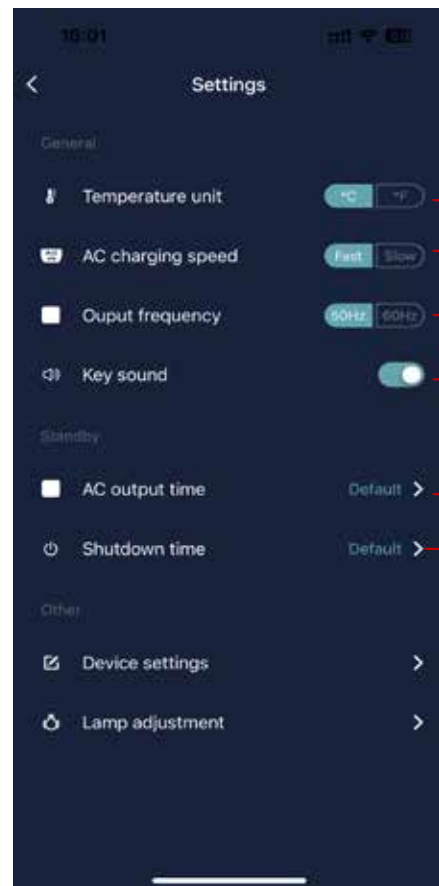

A. Switching temperature units
B. Switching charging speed
C. Switching output frequency
D. Pushbutton Sound Switch
E. Setting the AC output switching time
F. Setting the shutdown time

7. Error Prompt

Tips will pop up at the top of the page, and you can click to expand the view when multiple faults are present.

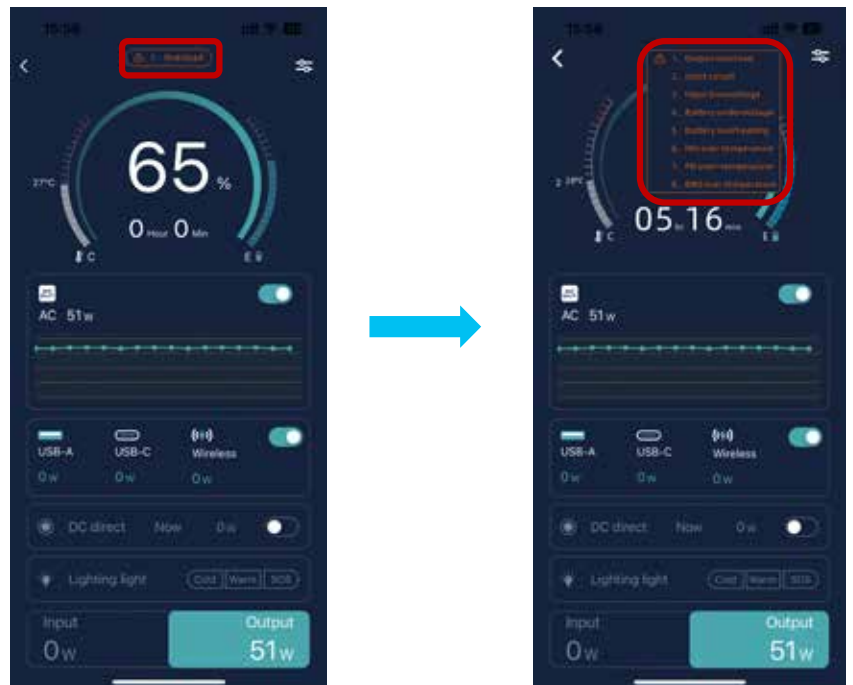

Warranty

Products that you buy directly from our **Powerology** website or shop come with a 24-month warranty.

The 24 months warranty applies to products purchased directly from our Powerology website or store. If **Powerology** products are bought from any of our verified retailers, then the product is eligible for only 12 months warranty. To extend your product's warranty, visit our website powerology.me/warranty and fill your details in the provided form along with an uploaded picture of the product to process your request. Once approved, you will receive a confirmation email of the extended product warranty. Upload the required information within 48 hours of purchase to be eligible for 24 months of warranty period.

For more info, please check:
powerology.me/warranty

Contact Us

If you have any questions about this Privacy Policy, please contact us at: hey@powerology.me

Website: powerology.me

Instagram: [powerology_official](https://www.instagram.com/powerology_official)

Facebook: [powerology.ME](https://www.facebook.com/powerology.ME)