

GY-271 ELECTRONIC COMPASS

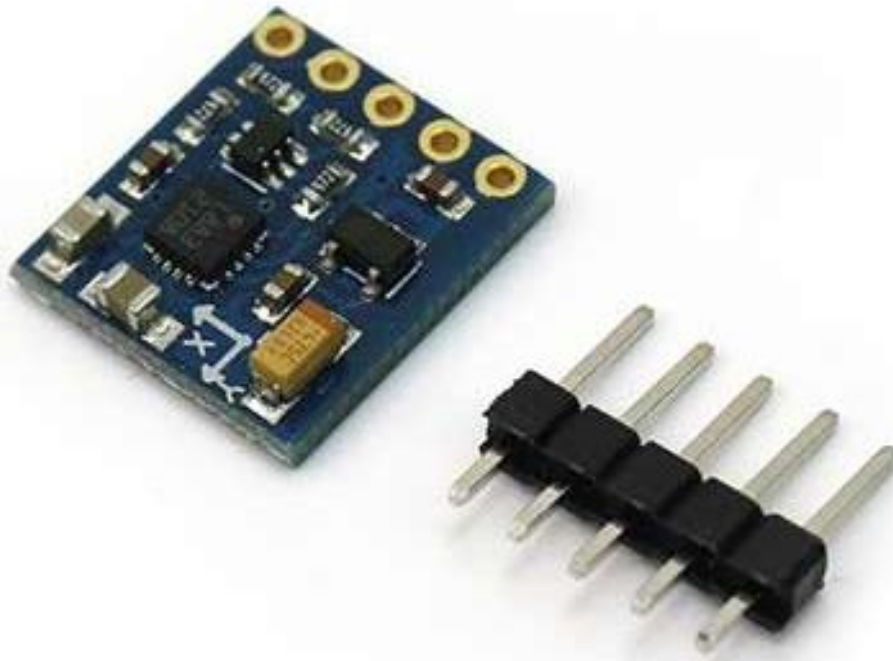

Description

The Compass Module is designed for low-field magnetic sensing with a digital interface and perfect to give precise heading information. This compact sensor fits into small projects such as UAVs and robot navigation systems. The sensor converts any magnetic field to a differential voltage output on 3 axes. This voltage shift is the raw digital output value, which can then be used to calculate headings or sense magnetic fields coming from different directions.

Specifications

- Power 3V-5V DC

- Chipset HMC5883L
- Communication via I2C protocol
- Measuring range: ± 1.3 -8 Gauss
- Dimensions 14.8 x 13.5 x 3.5mm

Pin Configuration

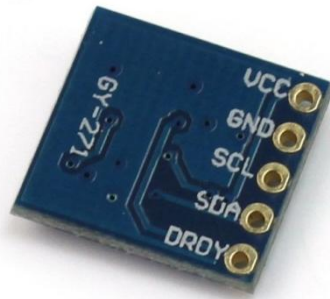

1. **VCC**: 3V-5V DC
2. **GND**: ground
3. **SCL**: analog input (A5)
4. **SDA**: analog input (A4)
5. **DRDY**: not connected

Wiring Diagram

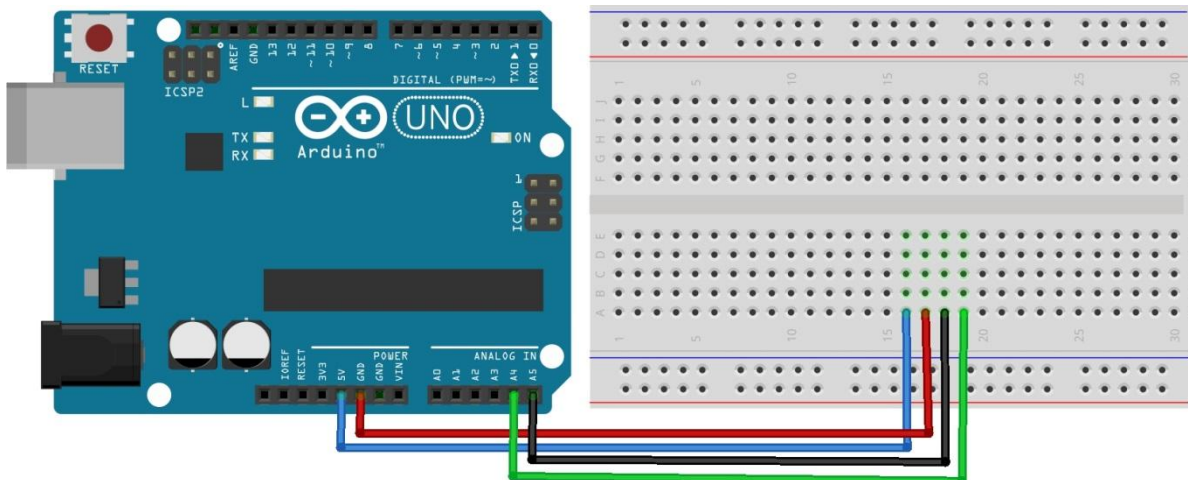

Schematic Diagram

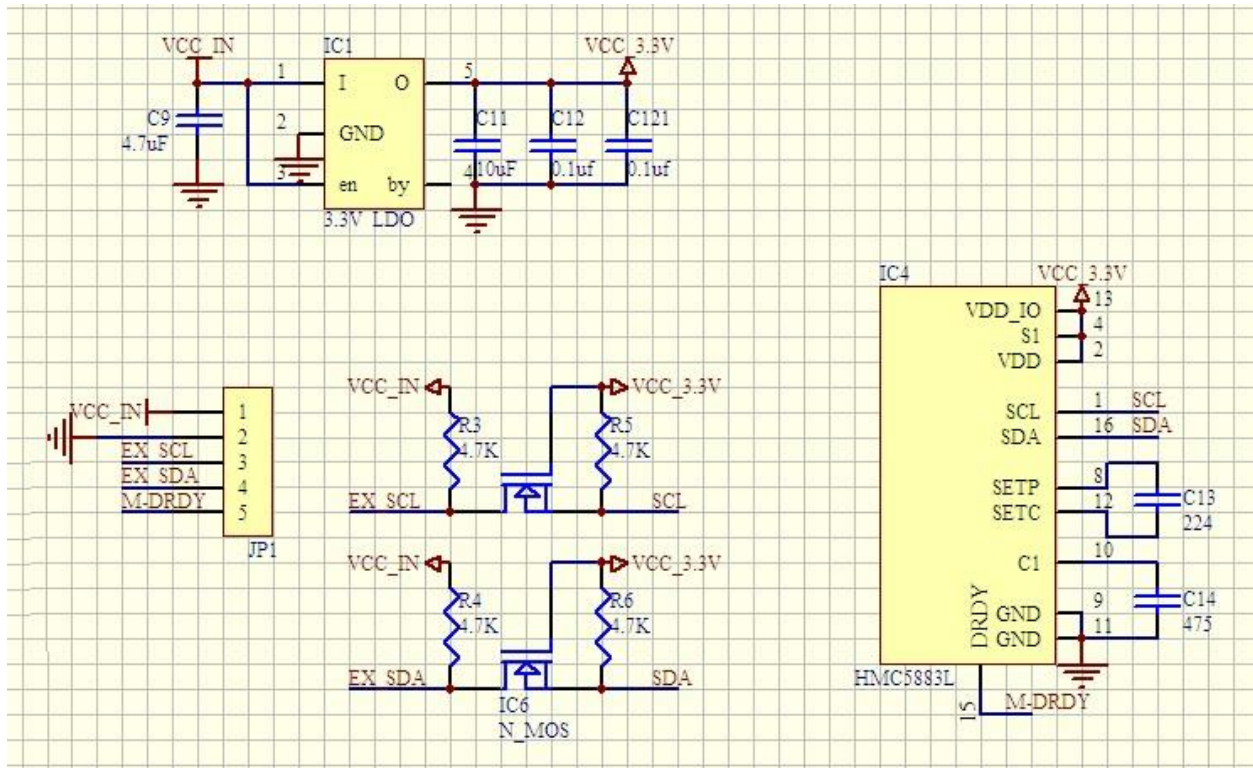

Sample Sketch

```
#include <Wire.h>
#include <HMC5883L.h>
HMC5883L compass;
void setup()
{
  Serial.begin(9600);
  Wire.begin();
  compass = HMC5883L();
  compass.SetScale(1.3);
  compass.SetMeasurementMode(Measurement_Continuous);
}
void loop()
{
  MagnetometerRaw raw = compass.ReadRawAxis();
  MagnetometerScaled scaled = compass.ReadScaledAxis();
  float xHeading = atan2(scaled.YAxis, scaled.XAxis);
  float yHeading = atan2(scaled.ZAxis, scaled.XAxis);
  float zHeading = atan2(scaled.ZAxis, scaled.YAxis);
  if(xHeading < 0) xHeading += 2*PI;
  if(xHeading > 2*PI) xHeading -= 2*PI;
  if(yHeading < 0) yHeading += 2*PI;
}
```

```
if(yHeading > 2*PI) yHeading -= 2*PI;
if(zHeading < 0) zHeading += 2*PI;
if(zHeading > 2*PI) zHeading -= 2*PI;
float xDegrees = xHeading * 180/M_PI;
float yDegrees = yHeading * 180/M_PI;
float zDegrees = zHeading * 180/M_PI;
Serial.print(xDegrees);
Serial.print(",");
Serial.print(yDegrees);
Serial.print(",");
Serial.print(zDegrees);
Serial.println(";");
delay(100);
}
```

How to Test

The components to be used are:

- Arduino Uno (any compatible microcontroller)
 - GY-271 electronic compass
 - Pin connectors
 - Breadboard
 - USB cable
1. Connect the components based on the figure shown in the wiring diagram using pin connectors. VCC pin is connected to the 5V power supply, GND pin is connected to the GND, the SCL pin is connected to A5 pin, and the SDA pin is connected to A4 pin.
 2. After hardware connection, insert the sample sketch into the Arduino IDE.
 3. [Download](#) and import HMC5583L into the library.
 4. Using a USB cable, connect the ports from the microcontroller to the computer.
 5. Upload the program.
 6. See the results in the serial monitor.

Testing Results

The serial monitor shows the results (X plane angle, Y plane angle, Z plane angle in degrees) of different positions of the module.

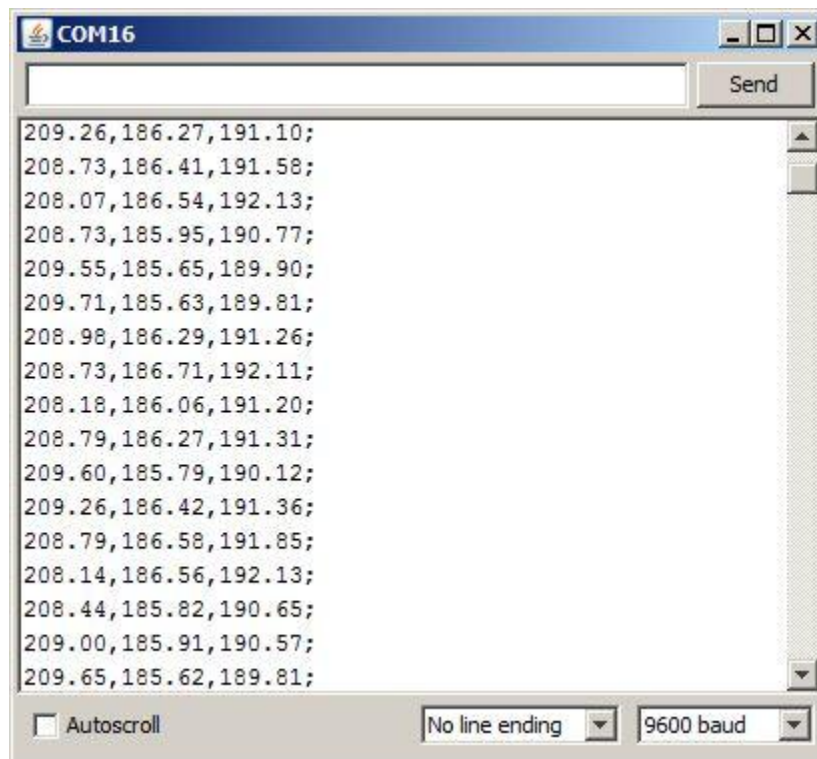
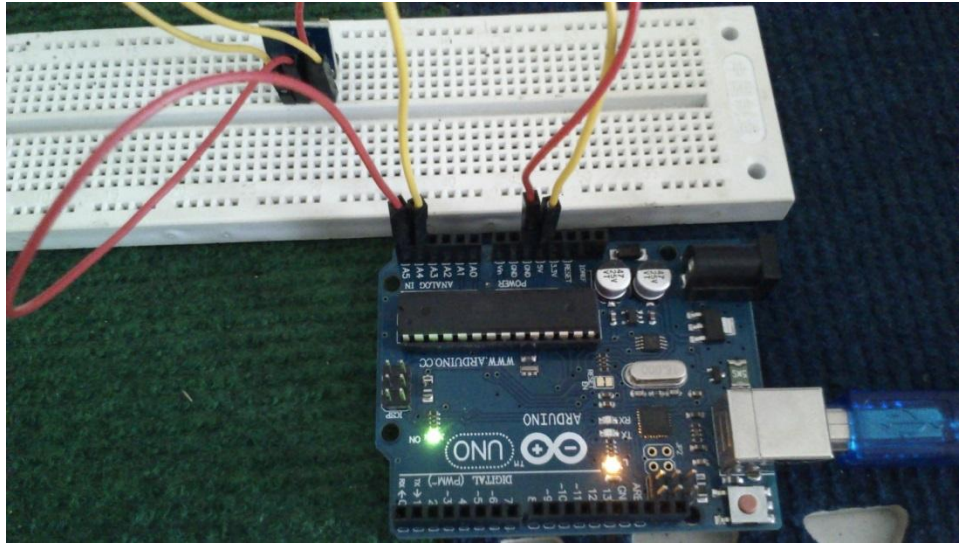

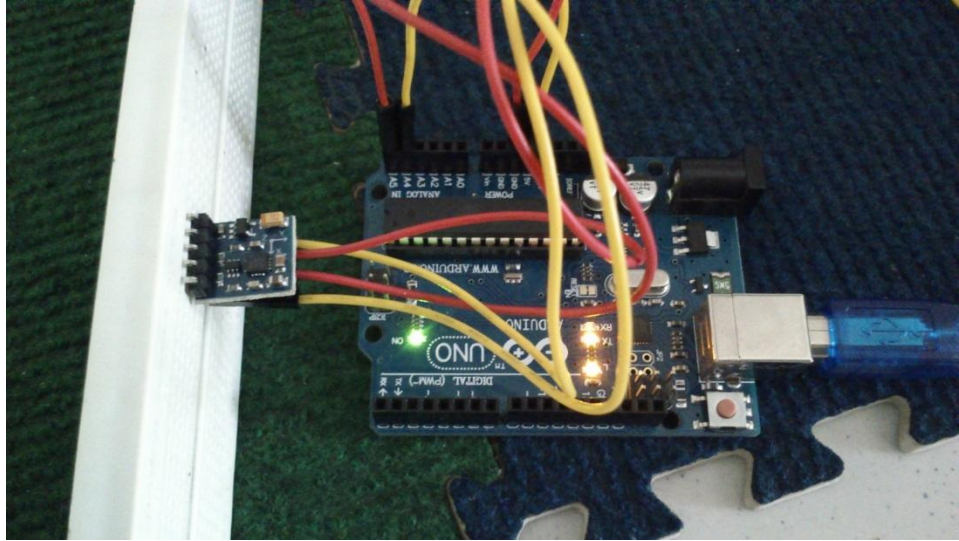

```
COM16
```

Send

```
169.74,187.70,323.27;  
169.91,186.46,327.53;  
171.11,187.83,318.67;  
170.41,186.22,327.17;  
170.51,187.22,322.84;  
174.46,190.54,297.55;  
176.64,192.48,284.85;  
168.99,187.24,326.86;  
168.21,186.65,330.82;  
168.69,186.02,332.21;  
168.84,186.69,329.26;  
168.78,187.48,326.49;  
169.46,187.07,326.31;  
168.42,186.76,329.93;  
168.16,185.07,337.07;  
167.72,185.68,335.45;  
168.25,186.69,330.57;
```

Autoscroll No line ending 9600 baud

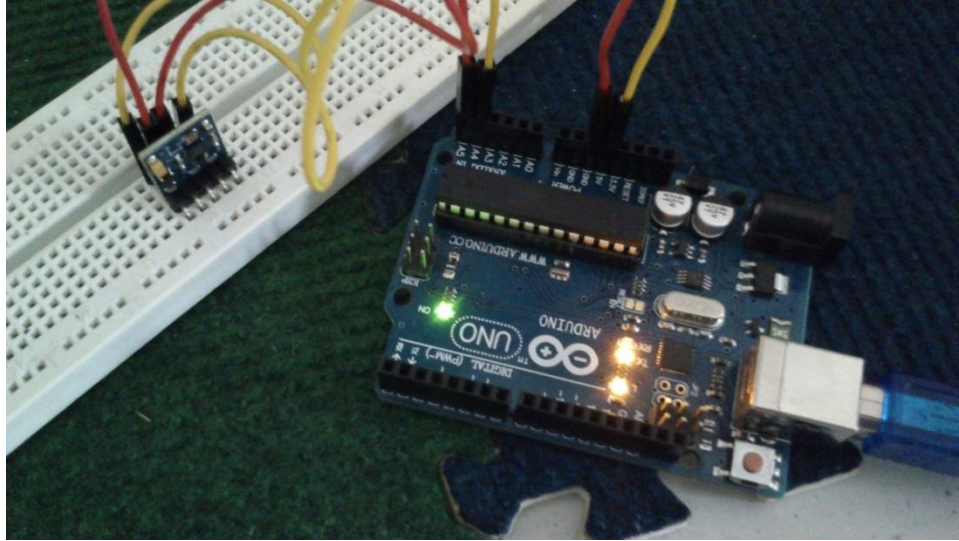

COM16

Send

```
89.13,89.55,62.72;  
89.71,89.85,63.02;  
91.76,90.89,63.14;  
92.34,91.19,63.02;  
92.01,91.04,62.61;  
89.71,89.85,62.60;  
90.00,90.00,62.89;  
90.29,90.15,62.67;  
90.29,90.15,63.08;  
92.60,91.35,62.60;  
91.73,90.91,62.30;  
89.42,89.70,62.42;  
89.13,89.55,62.54;  
89.42,89.70,62.42;  
91.74,90.89,62.78;  
91.15,90.60,62.54;  
90.29,90.15,62.60;
```

Autoscroll No line ending 9600 baud