



**CARPFISHING
GEAR GUIDE 19|20**



LIMITED LIFETIME WARRANTY

All K-Karp rods are marketed only after being subjected to stringent quality tests and compliance to the resistance specifications set by our experts. For this reason, K-Karp guarantees that all rods are free from any defect. The limited lifetime warranty covers the original purchaser against defects or breakage due to manufacturing defects and workmanship from the date of purchase. The lifetime warranty is limited to repair and / or to replacements and does not cover accidental breakage, not due to manufacturing defects. During the whole warranty

period K-Karp International (through the Italian distributor - Trabucco Fishing Diffusion) will repair and / or replace the product. Only the K-Karp, through Trabucco Fishing Diffusion, is authorized to repair and / or replace the damaged product. In addition, the warranty will be void if the product, after checking, will be found modified without authorization, or will show manipulation, misuse, abuse or damage caused by a lack of reasonable maintenance. For all cases in which the LIMITED LIFETIME WARRANTY cannot be applied, for example in all the cases in

which the product has suffered a damage cause of the normal wear and tear or improper use, it will be possible to require repair and / or replacement for the damaged parts. The price of the requested spare parts will include the cost of material, labor and shipping costs. Please contact your local distributor in order to get an estimation of costs.



INSPIRE THE NEXT

FROM CARPERS TO CARPERS

The creation of K-Karp products starts from the ideas of the K-Karp team. Our testers spend most of their time on the banks of rivers and lakes in a constant search for new techniques and innovative solutions, which are then transformed into the new products we offer our public.

There are no better experts in the world to develop fishing equipment. K-Karp also has a special department that takes the idea behind every product and develops it using the best materials and the latest design technologies. Just after months of work and testing to eliminate the smallest defects, our products are ready to be marketed. K-Karp's way of work extends this process to all its main products, reels, rods, pods, luggage and accessories. Only those products that pass the tests carried out in the field and quality controls on materials are put into production. In these pages you will find the result of our labour at your disposal for the greatest sport in the world...Carpfishing. Visit our website and read the leading specialist journals to keep you up to date on news and the launch of new products.

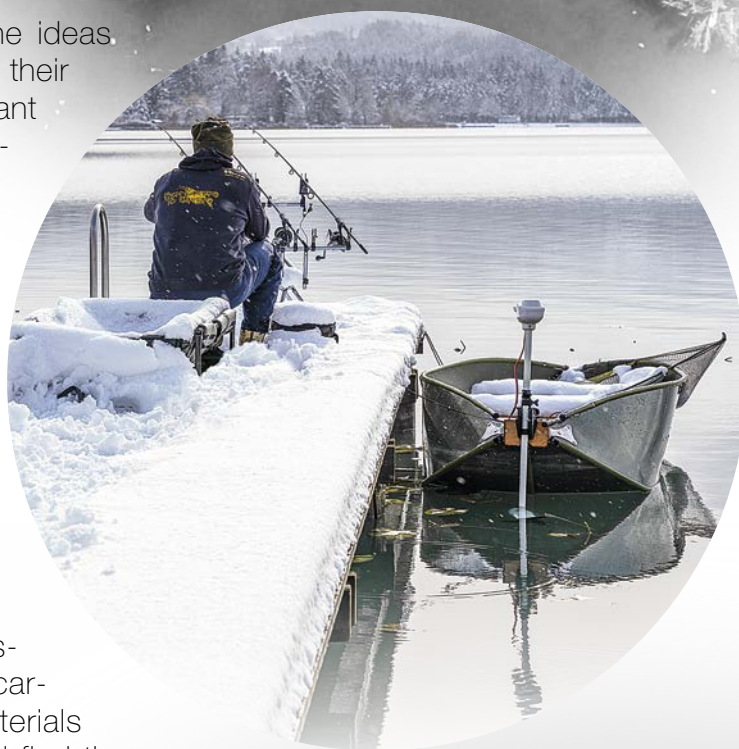

WWW.K-KARP.COM

■ Carp Rods	3	■ Rucksacks & Stalk Bags	43	■ Mainlines & Leaders	69
■ Carp Reels	13	■ Carryalls & Cooking Bags	45	■ Hooklinks	73
■ Bite Alarms	23	■ Organizers	47	■ Hooks	77
■ Hangers	27	■ Utility Bags	49	■ Ready Tied Rigs	81
■ Bait Boats	29	■ Rig Stations	53	■ Ready Tied Leaders	83
■ Shelters	31	■ K-Boxes	55	■ Bait & Feeding Accessories	85
■ Tent Accessories & Lamps	35	■ Carp Care	57		
■ Sleeping Bags	36	■ Rod Pods	61		
■ Bedchairs, Chairs & Accessories	37	■ Barrow	66		
■ Luggage	39	■ Pod Accessories & Metalware	67		
■ Holdalls	41				
■ Carryalls	42				



This publication does not contain all the products currently available in the K-Karp assortment. For the complete list of products, please visit our website.

CARP RODS

REAL CARPERS KNOW THAT THE TOOL THAT MAKES THE DIFFERENCE IS THE ROD.

This is why so many of them already own K-Karp rods. All models, irrespective of their cost, have been designed and stringently tested to offer the very best possible performance. Distance, precision and strength, these rods have all the characteristics that can be desired. Every model has innovative features, such as the special epoxy paints used for the wrappings, the latest anatomic reel-seat to provide maximum comfort and a perfect grip, the quality of the components and in particular guides as well as the new tying system that stays clean and unaltered over time. If you are an expert carp angler who wants to excel, or just an average enthusiast who wants to improve performance, these rods are the right choice for you!



RIVAL

With the Rival, K-Karp wanted to dedicate a rod to those who fish in many different ways. Rival can be actually used both for casting and in combination with a boat, thanks to the progressive action of the radial carbon blank. The Super High Modulus Radial Carbon is actually the only raw material used for the blank and guarantees top performance for a very long time. A special attention must be given to the genuine Fuji KW guides. Their peculiar shaped frame has been designed to avoid any risk of line tangle during casting action, especially when using big pit reels. These guides are suitable both for braided and monofilaments, having super smooth surface. Rival look is rigorous and it is well combined with elegant but aggressive specifications. This master piece is just the perfect rod to face every situation, still having a reasonable price. The joint is reinforced by a metallic ring and a long wrapping. HDE handle finishing with laser engraved bottom cap.



Fuji Alconite original guides, with special K design which prevents line from tangling around the frame.

EVA butt grip with laser engraved K-Karp logo on ultralight aluminium butt cap.

	SECT.	TEST CURVE
158-86-360 Rival 12'0"	2	3.00 lb
158-86-365 Rival 12'0"	2	3.50 lb
158-86-390 Rival 13'0"	2	3.00 lb
158-86-395 Rival 13'0"	2	3.50 lb





EXECUTOR

Developed around a Woven Carbon blank, extremely thin and reactive, this series offers the two lengths of 10 and 12 feet to blend under a unique dress, however elegant, the two souls of modern Carp Fishing. On one hand, fishing in commercial lakes with minimal equipment, which finds natural interpreters in the shorter rods, with the combination of medium-sized reels (6500 for example). On the other hand, the attention to long distances, still alive throughout Europe, which sees the 12 feet rods always leading the demand. Guide's configuration is designed with double leg frames and SiC rings, and include the 50 mm stripper on the 12 feet; the reel seats are sturdy and light, as they are made from graphite with rubber-lined steel hoods. Two heat-shrink rubber segments form the grip downstream of the reel seat and the refined super-slim butt grip, which ends with a K-Karp metal cameo. The essential finishes and the matt lacquering of the whole blank make these rods extremely current and appealing.

		SECTIONS	TEST CURVE
158-95-300	Executor 10'0"	2	2.75 lb
158-95-305	Executor 10'0"	2	3.00 lb
158-95-360	Executor 12'0"	2	3.00 lb
158-95-365	Executor 12'0"	2	3.25 lb





NEW 2019

FUSION XSK

Fusion XSK are designed to meet the demands of modern carp anglers, looking for a lightweight and manageable rod to cope with quick sessions, the margin stalking or the new Urban Style. Shorts and fast rods, easier to use in confined swims, easier to carry thanks to the extreme short closed length, Fusion XSK are designed in 3 or 4 sections separate sections according to the total length, with spigot joints for the maximum reliability. All the rods comes with a nice progressive action with a great backbone offering absolute casting accuracy and providing improved contact with battling carp. Stylish components with the full EVA handle, the matte black wrappings and the laser engraved cap, highlights once again the maximum attention to details.



		SECTIONS	TEST CURVE
158-89-225	Fusion XSK 7'5"	3	2.75 lb
158-89-270	Fusion XSK 9'0"	3	3.00 lb
158-89-300	Fusion XSK 10'0"	4	3.00 lb



FULCRON

It appears immediately as the element of overwhelming interest, but it isn't and can't be the only one. For K-Karp, aesthetics are critical, but the substance is equally important. So the 3D Camo finish, which has already accompanied Adamant reels to success, today characterizes these modern 9 feet rods dedicated to stalking, to fishing at short distances in the marginal bands of large lakes or in commercial ones, but also to the boat, a branch of carp fishing that also covers rivers and their very powerful carp. To demonstrate the great attention to detail, which is always a primary objective of K-Karp production, the decoration with three-dimensional natural patterns also invests the body of the reel seat, creating a very pleasant cosmetic effect. Under the dress, there is a two section's blank, created from High

Modulus carbon to obtain a balanced effect of resistance, reactivity and lightness, something apparently gentle but terribly strong at the same time. The reinforcement wrapping at the base of the top section is considered a must by most carpers, as well as the carbon line clip and the thin rubber grip at the base of the butt section, essential and efficient at the same time. The sturdy double leg guides with SiC ring are fixed by minimal black wrappings. Screw graphite reel seat with rubber lined steel hoods.

		SECTIONS	TEST CURVE
158-96-270	Fulcron 9'0"	2	2.50 lb
158-96-275	Fulcron 9'0"	2	2.75 lb



TIP PROTECTOR

Tip Protectors provide a valid solution to the protection of the tips and butts of your rods. Made in EVA anti-tear fabric, they hold the sections of your rods firmly together, and the neoprene tips protect against accidental knocks during transport. Excellent used together with the EVA Reel Case. Sold in packs of two different size bands.



		PCS/BAG
190-80-020/10	Tip Protector	2



Strong double leg guides with SIC ring, fixed by minimal black colour's wrappings.



The whole blank and reel seat's body are finely decorated with 3D natural images.



EVA ROD BANDS



Neoprene elastic bands to hold rod sections. Velcro on the outside ensures closure, while the inside is lined with rubber to prevent it slipping off the rod during transport. Excellent used together with an EVA Reel Case. Sold in packs of two different size bands.

		PCS/BAG
190-80-010/10	Eva Rod Bands	2



SNIPER

This series plays its cards on two fronts, starting from the classic two section's structure made from High Modulus carbon to obtain the necessary speed. Two rods designed with standard taper and guide's configuration, starting from a size 40 mm stripper, destined to short to medium distance fishing. Then another two expressly made for those carpers who love to fish at extreme long range, having a faster taper and fitting a size 50 mm stripper guide, destined to accept the wide line coils getting out from big pit reel's spool. The experience of K-Karp Team can be detected looking at components, which feature plenty of quality and full durability. Stainless steel frame double leg

SiC guides are supplied by SeaGuide, while the reel seat is signed by Webo, well known all over the world for precision and strength of their specialist gear.

		SECTIONS	TEST CURVE
158-78-360	Sniper 12'0"	2	3.00 lb
158-78-390	Sniper 13'0"	2	3.50 lb
158-79-360	Sniper LR 12'0"	2	3.50 lb
158-79-390	Sniper LR 13'0"	2	3.50 lb



Webo DPS screw reel seat, made from graphite and stainless steel. Shrink rubber super slim butt grip, with K-Karp logo engraved on aluminium butt cap.



The Standard and Long Range version also differ in guide's sizes. Standard Ø 40 mm, Long Range Ø 50 mm. On right, the EVA protection which avoids any damage during transport.

CRUSADER XT & LD

Rods with extremely fine cosmetic, with a matt black finish and minimal incidence of logos and screen printings, just as requested by today's serious carp anglers. Within the family, two series are available.



		SECTIONS	TEST CURVE
158-98-300	Crusader XT 10'0"	2	3.00 lb
158-98-360	Crusader XT 12'0"	2	3.00 lb
158-98-395	Crusader XT 13'0"	2	3.50 lb
158-99-360	Crusader LD 12'0"	2	3.00 lb
158-99-395	Crusader LD 13'0"	2	3.50 lb



The CRUSADER XT are built from SHM carbon, a material which allows to obtain very thin and extremely reactive blanks. Their action is parabolic progressive, funny in the retrieve and ideal when using very light hooklinks which are imperative in waters subject to high fishing pressure. The series is available with the AAA grade natural cork handle, in lengths of 10ft and 12ft with 3lb test curve, suitable for stalking and small water's fishing, up to 13ft 3,5lb perfect for long range job or to cast with PVA bags. The stainless steel frame Seaguide SiC guides are designed for long life, while the Webo reel seat firmly ensures the reel to the rod blank, without being too bulky.

The CRUSADER LD are dedicated to lovers of extreme long range. Two rods, a 12ft for 3lb and a 13ft for 3,5lb whose action, mainly tippy, hides a great versatility of the body, which is particularly appreciated during the fish fight, as it cooperates like a classical parabolic-progressive. The components are of the highest quality, with Seaguide SiC guides, perfect to protect the line from abrasion and to disperse the heat generated in the retrieve of larger fish. The handle is dressed with natural cork and finely decorated with a metal cap with the K-KARP engraved logo.



The high grade natural cork handle incorporates a light reel seat made from graphite, with steel hoods.



Double leg SiC guides: size 40 mm on XT serie's butt section; 50 mm on LD series.



K-Karp logo has a clear meaning of quality for the carpers all over Europe.





FUSION SPOD

The original name for this rod comes from the special carbon used: the Radial Fused Carbon, which is known for its qualities of strength and speed. The SiC Ultralight guides ensure lightness and offer extreme casting power, drastically decreasing the resistance on the line. The 5lb version is designed to cast big spods or bait rockets, while the 4lb, in addition to doing the same job, can be used with large marker during the delicate phases of plumbing. On both versions a visual signal has been applied (at one meter from the base) to facilitate measuring the water's depth. The blank has been specially designed to suit the casting style of the Carper, enabling outstanding distances to be reached. Extra qualities that will be appreciated when fishing are the reinforced joints and the fast action. These features have defined The Fusion as exceptional, as it can even be used to catch big cat fish.

		SECTIONS	TEST CURVE
158-69-360	Fusion Spod 12'0"	2	4.00 lb
158-69-365	Fusion Spod 12'0"	2	5.00 lb



Located at 1 metre from butt end, the silver line is useful to evaluate the swim depth.



DOMINANT

Series of rods which display outstanding power in spite of fine diameter handles, which take advantage from the speed and reliability of Radial Reverse Carbon, a material which is able to evenly distribute the stress along the blank. Consequently, all carbon layers cooperate perfectly, avoiding that peak of pressure cause breakages. The result is fantastic: slim rods which react to casting inputs and, at the same time, have enough power to stop and control those fast runs. According to the most recent trends in the European taste, these rods are minimally dressed, without fancy colours and with remarkably slim butt grip, covered by a rubber shrink tube and enriched by a K-Karp

logo on the metal cap. Guides are stainless steel framed double leg SiC quality from SeaGuide. At the base of top section, a fine metal ring reinforces the most critical area of the whole rod; screw reel seat is made from graphite and steel, and signed by Webo to offer outstanding quality.

		SECTIONS	TEST CURVE
158-93-360	Dominant 12'0"	2	3.00 lb
158-93-390	Dominant 13'0"	2	3.00 lb



DESTINY

This series has been expressly designed for long range fishing fans, to whom it offers the great recovery speed of High Modulus carbon and a guide configuration suitable to work with big pit reels. The stripper guide is a size 50 mm in order to smoothly drive the wide line coils to next rings. The fast tapered blank gives a certain "body" to the rod, which can be heavily loaded during casting action and which can bear enormous stress when trying to stop a fast fish run, preventing him to reach safe covers. Guides are made from stainless steel double leg frames and SiC rings to protect line from abrasions and dissipate heat in case of big fish catch. In the joint region, the top section's bottom end is guarded by a thin metal ring, while the handle area is reinforced by woven carbon to resist anything, and fits a shrink rubber tube to create a superslim grip.

		SECTIONS	TEST CURVE
158-94-360	Destiny 12'0"	2	3.50 lb
158-94-390	Destiny 13'0"	2	3.50 lb





Webo DPS screw reel seat made from graphite and stainless steel. Soft rubber super slim butt grip. SIC SeaGuide double leg rings (50 mm stripper).

The metal ring which protects the bottom end of top section is highly in demand among expert carp anglers, because it saves one of the rod's most critical areas.





ADAMANT XTC

This rod has been made specifically for the carp anglers who love to fish in the wider continental waters, river or lakes. The XTC acronym stands for Extreme cast, a forced name given after the extended testing we made with this rod. The tip action hides a great adaptability of the blank mainly during combat, which makes it look like a classic parabolic progressive while maintaining long casting capability. Our tester achieved surprising great casting distances right with this blank, thanks solely to the Radial Reverse Carbon construction, a peculiar carbon with unique reactivity property. The first guide is a 50mm SiC guides, and it could not be other than this since we are speaking about a long casting rod, allowing the line to exit the spool of the reel without being strangled by a too small guide. We used handmade wrappings and protection rings to complete and make it even more nice the finish of Adamant XTC. Butt section is equipped with the exclusive protection knob laser engraved with K-Karp logo.



	SECTIONS	TEST CURVE
158-82-360 Adamant XTC 12'0"	2	3.00lb
158-82-390 Adamant XTC 13'0"	2	3.50lb

PHOENIX ELITE

Full Radial Carbon blank rod designed for those anglers who desire a very good product without spending too much. Remarkable are both the colour, very appealing under direct sunlight, and the parabolic progressive action obtained through an accurate computer planning and a wise distribution of the guides. Due to this and to a wide range of models we got a versatile rod suitable for every situation. To support a very wide range of use, 40mm SiC rings were mounted obtaining a perfect mix between stoutness and versatility. Phoenix Elite rods are at home with nylon monofilaments as well with braided lines, during marginal or long range situations. These rods has been made to offer the expert carper high level performance tool in every condition. Precision details like the allignment spine lines printed at the 2 pieces join and the protection butt knob, laser engraved with K-Karp logo are the right way to complete cosmetic of such a value for money series of rods.

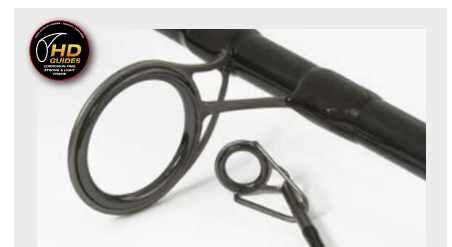

	SECTIONS	TEST CURVE
158-83-360 Phoenix Elite 12'0"	2	3.00 lb
158-83-365 Phoenix Elite 12'0"	2	3.50 lb
158-83-390 Phoenix Elite 13'0"	2	3.00 lb
158-83-395 Phoenix Elite 13'0"	2	3.50 lb

Light and strong double leg HD SIC guides, with 40 mm size on butt section.



GLADIO X3

Family of rods designed for those who like to have a full battery of quality rods but with reduced encumbrance, thanks to the 3 pieces construction. The special S.H.M. Carbon made blank allows performance very similar if not identical to a classic 2 pieces rod, having the same specs of accuracy, long range cast and reliability. The attention we used to produce this rod is extreme: 50mm SiC guides, longer reinforced guide wrappings, preserving bushes in the joint: all this highlight a really one of a kind product. Last but not least the reel seat has been designed with computerized techniques and it has been combined with a high density EVA handle that allows a firm grip in all conditions.



Guide's alignment marks for quick fitting and metal rings to protect joints.

Light and strong double leg HD SiC guides.

Super fine woven carbon line clip, fitted on right side of butt handle.

		SECTIONS	TEST CURVE
158-38-360	Gladio X3 12'0"	3	3.00 lb



IMPERIAL

Series designed in three pieces and built from High Modulus carbon. The rod has a great reserve of power and an enjoyable action, which is surely comparable to that of a two piece model. High quality components are used to finish the blank: high density EVA handle covering the handle grip, aluminium ring reinforcements around joints, double leg SiC Titanium guides.



Laser engraved K-Karp logo.

Light and strong double leg HD SiC guides.

		SECTIONS	TEST CURVE
158-52-360	Imperial 12'0"	3	3.00 lb
158-52-390	Imperial 13'0"	3	3.00 lb



ARATON



Extreme care in every detail provide the fine pleasure to own a K-Karp rod.

Light and strong double leg HD SiC guides.

All the features you would like to find in a modern carp fishing rod are present here in our Araton series. Reliable, powerful and displaying a superb progressive action, it has been designed according to the strict standards listed by K-Karp Team. As a matter of fact, High Modulus carbon blanks, double leg titanium SiC guides, reliable reel seat and high density EVA handle make these rods absolutely unbeatable at this price level.

		SECTIONS	TEST CURVE
158-41-360	Araton 12'0"	3	3.00 lb
158-41-390	Araton 13'0"	3	3.00 lb



CARP REELS

K-KARP reels have quickly become successful among carpers. That's why we can say that our reels have become a benchmark in terms of quality and technical innovation. K-KARP uses the best materials and world-class technology in their construction.

Our aim is to offer high quality reels and to this end we use only components such as: self-lubricating ball bearings for great fluidity in recovery and new design gears, spools made from cold-cast duraluminium for perfect spooling and very long casts; single piece Power Fighting handles, Runner System clutch with extra-large PTFE disks for perfect progression and fluidity in any condition.

The utmost attention has been paid to the mechanics by K-KARP's staff who are always ready to take on the challenges imposed by the market.



Carp Runner

This device allows to switch from the free spool system to the pre-setting fish playing drag by just turning the handle. The drags used on K-Karp reels feature oversized washers, and all our reel have been deeply tested by our staff before the release; for these reasons we can say that K-Karp reels are probably the most reliable reels on the market nowadays.



Antitwist Line Roller

At every turns of the handle, the conventional line rollers force the line to twist on itself causing annoying tangles. The Anti-Twist Line Roller dramatically reduces the line twist problem thus reducing the wearing of your line.



Slow Oscillation System

With this revolutionary system, the rotor turns at a very high speed while the spool makes its oscillation up and down at a slower speed. This action delivers perfect parallel winding, thereby avoiding the line tension from normal spooling movements and therefore making longer casting easily possible.

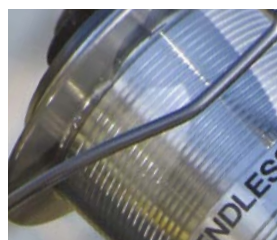

Hollow Bail

In several models, we introduced a aluminium tubular bail that is larger in diameter than common, solid ones. Although larger, these new bails are lighter and more durable than traditional ones.



X-Cross System

The spooling is very tidy with Cross Winder, providing good casting distance and reducing the possibility of tangles. The "X" spooling in fact compacts the line and allows a best spooling. This system can be employed for both monofilaments and braided lines.



Super Balance System

This new technology is obtained just using the latest computers 3D softwares, which allow the designing - and later the construction - of perfectly balanced rotors, without the addition of external weights.

Super Balance System

V-Spool Design

The V-Spool Design spools reduce the friction between line and the lip during the cast, reducing the number and the diameter of the coming out coils and thus dramatically dropping the risks of tangles when using braided lines. The lower friction make your casts longer and more accurate too.

Safe Cast System

The Safe Cast System prevents the accidental bail closure by completely locking the rotor and the handle, when the bail arm is opened and ready to cast. On reels featuring the Safe Cast System is strongly recommended to manually close the bail.



WATCH THE VIDEO



ABSOLUTE VX



Half a turn of the knob gets the dual setting drag system totally open or closed. Practically, it's like a miniature Carp Runner concept.



The hollow bail is lighter and stronger than traditional solid ones. The line roller has been designed to avoid the dangerous torsion generated during the line retrieve.



The high tech graphite body has a superslim profile. A tough shell which contains a huge engineering experience.

The spool which oscillates so slowly sends a strong message to the user: the Absolute VX has the special vocation to perfectly spool the line! And this is not a fashion issue, but a great, concrete advantage, because if the line is so nicely spooled, for sure it will get out quickly and neatly, without causing any dangerous tangle nor knots. All this is absolutely vital for a big pit reel, whose configuration clearly says that it's destined to super long range fishing, with its great capacity long cast tapered spool. On top of the spool, there are two knobs: a small one to pre-select the drag level, and a second, larger one aimed to activate the Fast Play Drag system, enabling to switch it On and Off by just half a turn. The lightness, the smoothness, the balance and comfort provided by swept handle are the additional merits of a reel which has the chromosomes to be a leader not only in the K-Karp range, but also in the world of high quality reels. An absolutely elegant, black dressing is just what finest carpers want.

FAST PLAY DRAG

Advanced Pre-Setting Dual System

- 6 SS Long Life Ball Bearings
- 1 SS Long Life Roller Bearing
- One Way Clutch with Infinite Anti-Reverse
- Worm Shaft System
- Super Slow Oscillation System
- Fully Sealed Fast Play Drag System
- PTFE Coated Magnum Drag Washers
- Computer Balanced System
- Safe Cast System
- High Strength Engineered Xtra Tough Body
- Double Strength Stainless Steel Main Shaft
- Long Cast Superlight Aluminium Spool
- Hollow Bail
- CNC machined Aluminium Handle with Soft Knob
- Anti-Twist Line Roller with Titanium Nitride Coating

		WEIGHT	GEAR RATIO	CAPACITY	BALL BEARING
037-82-800	Absolute VX 10000	700	4.3:1 (108 cm)	Ø 0.35 - 480 m	6+1
037-82-801	Absolute VX 10000 Spare Spool				



REACTION VX

The flagship of K-Karp reels is for sure the brilliant Reaction VX. This reel has been designed to face to most challenging waters in Europe, fighting the biggest carp with the best features you can find on a carp fishing reel. K-Karp was studying on this new reel since a couple of years with the aim to create a reel that could suit both shore casting anglers and anglers that prefer to position their baits using a boat very far from the shore. We applied the "Advanced Safe Cast System" that actually blocks the rotor as soon as the bail arm is opened, whatever its position. This safety system has been widely field tested by the whole K-Karp team in a number of situations, and avoids accidental closure of the bail during the most powerful casts just turning the handle forward. The carp-runner system is very accurate and allows to move from the free drag to the preset drag. The sealed drag discs are alternate stainless steel and carbon, allowing a very accurate and long lasting presetting. You can find many other top level features on the Reaction VX, such as the hollow bail, the Worm Shaft gear for perfect line lay, the anti twist roller and the fighting aluminium handle.

FIGHTING **10Kg** MAX DRAG
CARP RUN **2 Kg** MAX DRAG



		WEIGHT	GEAR RATIO	CAPACITY	BALL BEARING
037-76-800	Reaction VX 8000	497	4.7:1 (97 cm)	Ø 0.35 - 520 m	10+1
037-76-801	Reaction VX 8000 Spare Spool				

ADVANCED CARP RUNNER SYSTEM

- 10 SS Double Shielded Long Life Ball Bearings
- 1 SS Long Life Roller Bearing
- One Way Clutch with Infinite Anti-Reverse
- Worm Shaft + SOS System
- Computer Balanced System
- Safe Cast System
- Hollow Bail
- Duralumin Power Fighting handle
- Anti-Twist Line Roller with Titanium Nitride Coating
- PTFE coated Drag Washers
- Water & Dust Proof Drag
- Double Strength Stainless Steel Main Shaft
- Long Cast Duraluminium Spool
- Duraluminium Spare Spool sold separately



FIGHTING **8 Kg** MAX DRAG
CARP RUN **2 Kg** MAX DRAG



REACTION XT

A fantastic "Big Pit" that comes from high level experiences in the field of surf casting, a discipline that shares many aspects with carp fishing, primarily the need to cast far, very far away, without incidents affecting the fishing line. In all this the Reaction VX excels brilliantly, with its large tapered spool which dominates in terms of volumes and proportions, in contrast to the very compact body. Thanks to the job done by the worm shaft, the fishing line is neatly wound in the spool's core, with angled and crossed coils that don't hinder each other when the casting force draws them quickly off the spool. A special subframe, inserted between the spool's skirt and the structure of the rotor, prevents the fishing line from dropping down accidentally, putting at risk the safety of the entire system. The important work of driving the retrieve is in charge of a special aluminum handle, featuring a large rubber knob, whose arm is shaped to follow the profile of the rotor, without unbalancing the reel and without dispersing the force exerted by the user. In order to prevent the bail from flipping during the delicate time of casting, the Reaction XT is not provided with the automatic closing device, forcing the user to operate manually (Safe Cast System). Beyond the risk of rod's breakage, this problem could endanger other anglers on the same water, because the fishing line, when breaking, would release the lead into an uncontrolled flight.

		WEIGHT	GEAR RATIO	CAPACITY	BALL BEARING
037-77-800	Reaction XT 8000	550	4,7:1 (97 cm)	Ø 0,35 - 380 m	8+1
037-77-801	Reaction XT 8000 Spare Spool				

ADVANCED LONG DISTANCE SYSTEM

- 8 Double Shielded Long Life Ball Bearings
- 1 Stainless Steel Long Life Roller Bearing
- Hi-tech X-Tra Tough Graphite Body
- Long Cast Ultralight Aluminium Spool, with new profile lip for longer casts
- Aluminium Hollow Bail with Anti Twist Line Roller
- Micro-adjustable drag, sealed against corrosion
- Double Strength Stainless Steel Main Shaft
- Infinite Anti Reverse
- Worm Shaft + SOS System
- Safe Cast System
- Aluminium Power Fighting Handle, with Oversized Rubber Knob



The special frame which follows the spool during its vertical oscillation has two arms which prevents line from slipping below the spool's skirt, thus avoiding dangerous tangles.



The advanced drag system is based on large diameter's disks, in order to disperse heat. The drag box is sealed by a rubber lining which keeps water and dust away.

FUSION

With an attractive total black look, following the latest trends Fusion are fully packed with innovative solutions. The 6500 is the perfect choice for stalking but it holds enough line to medium-long range, while the 12000 is feeling home when long and accurate casting is required. Fusion features extra large spools compared to the bodies, Worm Shaft Gear combined with the S.O.S. System for a perfect line lay both with braid and mono, line guard brushes, while the CNC fighting handle ends with a retro-style wooden handle knob for a stylish touch.

ADVANCED CARP RUNNER SYSTEM

- 7 Long Life Ball Bearings
- 1 Long Life Roller Bearing
- Worm Shaft + SOS System
- Infinite antireverse “One way”
- Dual-Presettings Carp Runner Drag
- Long Cast Duraluminium Spool
- PTFE Drag Washers
- Salt & Dust Proof Drag
- Line Guard Protectors
- AS Line Roller (antitwist system)
- Aluminium Power Fighting Handle
- Hollow Bail
- Graphite Spare Spool

		WEIGHT	GEAR RATIO	CAPACITY	BB SYSTEM
037-81-065	Fusion 6500	550	4.8:1 (90 cm)	Ø 0.30 - 450 m	7+1
037-81-120	Fusion 12000	830	4.3:1 (100 cm)	Ø 0.35 - 530 m	7+1



ENDLESS

This Big “Free Runner” reel presents a new drag system located on top of the spool. In this new device, setting of the main drag and extra drag are independent. The result is a truly micrometric adjustment system that allows you to switch from free to the default modality, just turning the switch about half a lap. During the fight, drag adjustment of one notch makes the difference. When playing a fish the angler will really appreciate the quickness of Fast Play Drag system, which ensures perfect fish control.

**FAST
PLAY DRAG**

FAST PLAY DRAG Advanced Pre-Setting Dual System

- 7 Long Life Ball Bearings
- 1 Long Life Roller Bearing
- Worm Shaft + SOS System
- Infinite antireverse “One way”
- Dual-Presettings Fast Play Drag
- PTFE Drag Washers
- Water & Dust Proof drag
- Duralumin Power Fighting handle
- Antitwist Line Roller
- Hollow Bail
- Graphite Spare Spool



Fast Play Drag

Innovative drag system featuring a dual-presetting mode that incorporates in a single device all the free runner drag facilities. It works directly into the spool, allowing to have a more direct, progressive and fine tuning drag system. The free spool setting is regulated by the inner knob, while to switch to the combat drag is enough to half turning the main drag knob.



		WEIGHT	GEAR RATIO	CAPACITY	BALL BEARING
037-80-550	Endless 6500	420	4.8:1 (98 cm)	Ø 0.30 - 170 m	7+1
037-80-700	Endless 8000	578	4.8:1 (103 cm)	Ø 0.35 - 440 m	7+1
037-80-800	Endless 10000	724	4.3:1 (104 cm)	Ø 0.35 - 530 m	7+1



ADAMANT XTC & 3D CAMO

ADVANCED CARP RUNNER SYSTEM

- 6 SS Long Life Ball Bearings
- 1 SS Long Life Roller Bearing
- Computer Balanced System
- Safe Cast System
- Worm Shaft Gear with Slow Oscillation System
- Fully Sealed carp Runner drag System
- Micro Adjusting Power Drag with Oversized Washers
- Anti-Twist Line Roller with Titanium Nitride Coating
- Double Strength Stainless Steel Main Shaft
- One Way Clutch with Infinite Anti-Reverse
- Hollow Bail
- Long Cast Superlight Spool
- CNC Fighting handle
- Spare Graphite Spool



The handle's knob is made from rubber and has an asymmetric shape to provide total control. As a matter of fact, such detail comes from big game multipliers.

Adamant XTC is the first Carp Runner K-Karp reel featuring a super compact body. Such advantage is due to the fact that the free spool system works on a separate axis, which runs parallel to main shaft. As a consequence of such design, the knob which is destined to adjust it is not protruding from back end of the body, but it's almost incorporated in its profile. The spool of the 12000 size has a really huge capacity, which goes in excess of 500 metres of 0,35 mm line, thus answering the demand of the lovers of extreme distance carping. A superlight frame, located at the base of the spool, avoids the line to slip down the skirt, making local tangles a thing of the past.

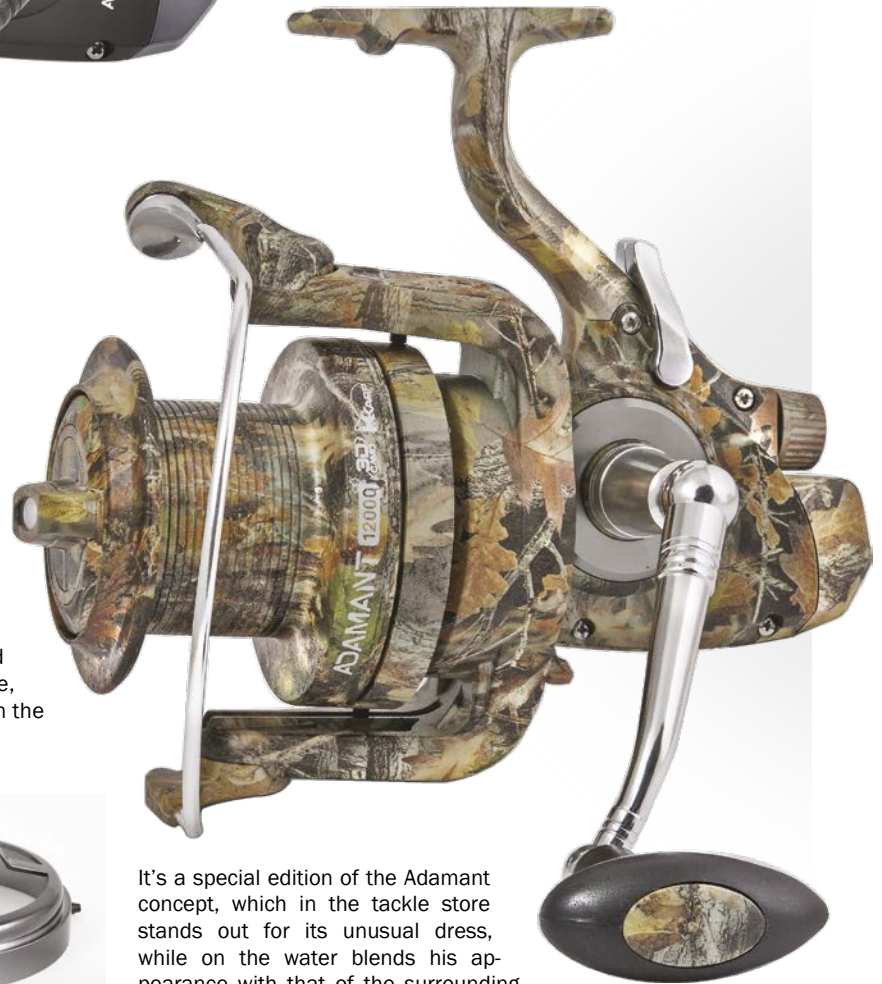

Extra spool exactly same as the main one.



The special frame which follows the spool during its oscillation has two arms which avoid line to slip below the spool's skirt, thus avoiding dangerous tangles.

It's a special edition of the Adamant concept, which in the tackle store stands out for its unusual dress, while on the water blends his appearance with that of the surrounding vegetation, thanks to an exclusive camouflage lacquering displaying a three-dimensional effect (3D Camo). Discreet look, but anything but sheltered from the standpoint of technology and performance, with a spool offering an enormous line capacity, able to fully satisfy the fans of extreme long range carping.



The Adamant body is the most compact among Carp Runner reels, because the free runner system works on a separate axis.

Thanks to an exclusive technology it has been possible to pigment the entire reel with 3D vegetation patterns, resulting in a very realistic effect. Those who fully respect the nature, living in harmony with it, will appreciate this K-Karp idea.



		WEIGHT	GEAR RATIO	CAPACITY	BALL BEARING
037-98-800	Adamant XTC 8000	590	4.9:1 (104 cm)	Ø 0.35 - 420 m	6+1
037-98-990	Adamant XTC 12000	790	4.7:1 (108 cm)	Ø 0.35 - 540 m	6+1
037-98-805	Adamant 3DCAMO 8000	560	4.9:1 (100 cm)	Ø 0.35 - 420 m	6+1
037-98-995	Adamant 3DCAMO 12000	740	4.7:1 (108 cm)	Ø 0.35 - 540 m	6+1

GLADIO LD



The K-Karp reels offer includes this reel dedicated to difficult and tough conditions, where power is the first requirement needed. The Gladio LD meets caster's needs as well, thanks to the wide and tapered spool, making it the right choice for a really huge number of anglers. So strength is the key word for this reel, designed accurately in every detail to increase reliability and power. Long distance fishing fanatics will appreciate the Safe-Cast System, a feature stopping the rotor of the reel during the cast, avoiding accidental closing of the bail arm.

Additional specs are the tubular Power Bail, the Worm Shaft crossing line lay and the Hi-Impact Line Clip, preserving the integrity of the line when it is blocked during the casting action.

ADVANCED LONG DISTANCE SYSTEM

- 6 Long Life Ball Bearings
- 1 Long Life Roller Bearing
- Worm Shaft + SOS System
- Infinite antireverse "One way"
- Safe-Cast System
- PTFE Drag Washers
- Water & Dust Proof Drag
- Line Guard Protectors
- AS Line Roller (antitwist system)
- Aluminium Power Fighting Handle
- Hollow bail for lightness and strength
- Graphite Spare Spool

	WEIGHT	GEAR RATIO	CAPACITY	BB SYSTEM
037-92-990 Gladio LD 12000	725	4.7:1 (107 cm)	Ø 0.40 - 480 m	6+1

EXCELLENCE

This "Big Free Runner" is exceptional for big fish. Fitted with four sealed anti-corrosion ball bearings and an unlimited anti-reverse Roller Bearing, aluminium spare spool, anti-tangle system, flow concept bail, worm shaft cross winder, one piece forged fishing handle with oversize ergonomic grip, light aluminium alloy body. Exceptional lightness and extraordinary power are the hallmarks that make this item outstanding on the market.

ADVANCED CARP RUNNER SYSTEM

- 7 Long Life Ball Bearings
- 1 Long Life Roller Bearing
- Worm Shaft + SOS System
- Infinite antireverse "One way"
- Dual-Presettings Carp Runner Drag
- Long Cast Duraluminium Spool
- PTFE Drag Washers
- Salt & Dust Proof Drag
- Line Guard Protectors
- AS Line Roller (antitwist system)
- Aluminium Power Fighting Handle
- Hollow Bail
- Graphite Spare Spool



	WEIGHT	GEAR RATIO	CAPACITY	BALL BEARING
037-83-990 Excellence 10000	830	4.3:1 (104 cm)	Ø 0.35 - 530 m	7+1



GLADIO 3D CAMO

It's a brilliant stylistic masterpiece, performed thanks to the new 3D Camo technology on the structure of Gladio LD, the legendary Big Pit who won legions of anglers with its reliability and with the clean lines of his profile. The new finish updates the image of the reel with an innovative look, without deleting the original model from K-Karp range, where it continues his exciting career. With such a wide spool, you can do everything you like: cast to the sky or put the hookbait some hundreds of meters away with the help of the boat, knowing that you can count on a particular power ratio when the carp will have to travel all that road to the landing net.

ADVANCED LONG DISTANCE SYSTEM

- 6 Long Life SS Sealed Ball Bearings
- Long Life One Way bearing
- Safe Cast System
- Worm Shaft for a perfect line lay
- Front Drag System with PTFE disks
- One Way Infinite Antireverse
- Aluminium Hollow Bail
- TiN coated Antitwist Line Roller
- Superlight Long Cast Aluminium Spool
- Power Fight Aluminium Handle
- Graphite Spare Spool



Thanks to an exclusive technology it has been possible to pigment the entire reel with 3D vegetation patterns, resulting in a very realistic effect. Those who fully respect the nature, living in harmony with it, will appreciate this K-Karp idea.

		WEIGHT	GEAR RATIO	CAPACITY	BALL BEARING
037-92-995	Gladio 3D CAMO 12000	715	4,7:1 (107 cm)	Ø 0,40 - 480 m	6+1

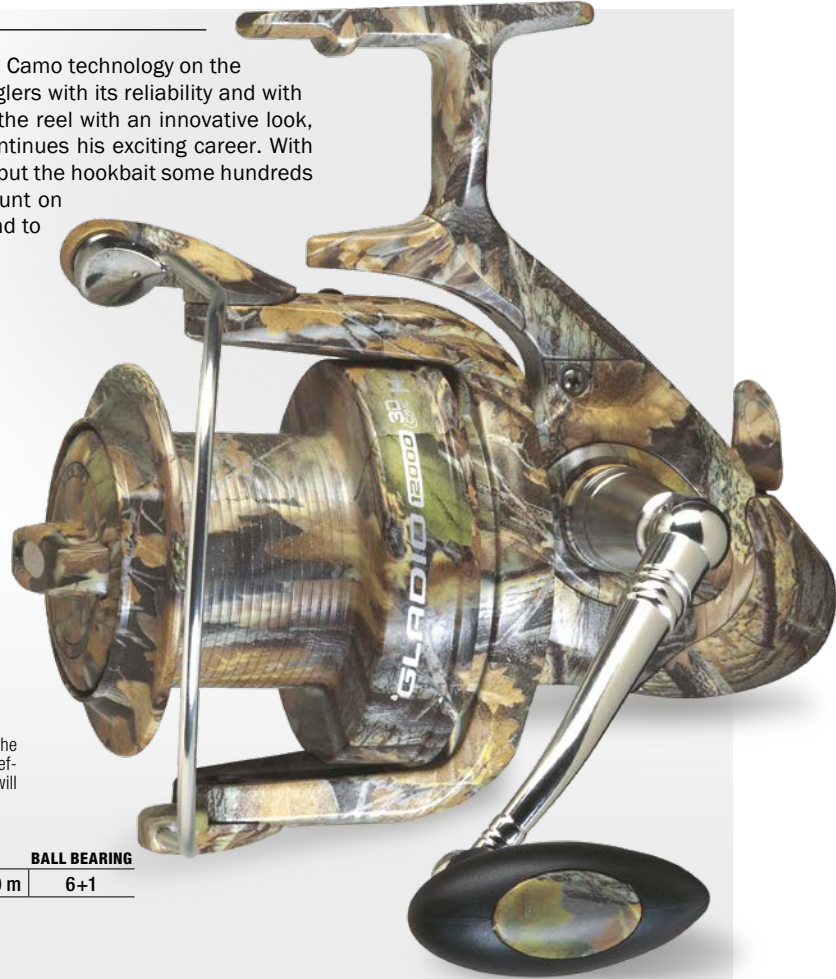

AVENGER XS



This reel is dedicated to those anglers who approach the technique of carp fishing with attention for exceptional value for money. Avenger is loaded with quality features, the hollow aluminium bail and two ball bearings and one roller bearing to ensure that this reel meets the demands of those anglers.

CARP RUNNER SYSTEM

- 2 Long Life Ball Bearings
- 1 Long Life Roller Bearing
- Infinite antireverse "One way"
- V-Spool Design
- Hollow Bail
- Long Cast Duraluminium Spool
- AS Line Roller (antitwist system)
- Aluminium Power Fighting Handle
- Graphite Spare Spool

		WEIGHT	GEAR RATIO	CAPACITY	BB SYSTEM
037-95-600	Avenger XS 6000	497	5.2:1 (90 cm)	Ø 0.30 - 340 m	2+1



BITE ALARMS

PULSAR ADS



PULSAR ADS BITE INDICATORS SET

Since it was introduced, the Pulsar has set new standards for bite indication and reliability in all conditions and we are sure your purchase will prove to be a worthwhile investment that will last you several years. Pulsar ADS is an ultra-reliable, compact, high quality, bite indicator set packed with the latest cutting edge technologies.

019-27-000	Pulsar ADS Bite Alarm Set 3+1
019-27-010	Pulsar ADS Bite Alarm Set 4+1
019-27-100	Pulsar ADS Alarm
019-27-101	Pulsar ADS Receiver
019-27-110	Pulsar ADS Snag Bars
019-27-120	Pulsar ADS Cover Set 4+1



Volume, Tone, Sensitivity & Wireless. Volume, tone and sensitivity can be adjusted by rotating the controls, familiarise yourself with the controls before connecting the batteries.



Multicolour Led Selection with Brightness Adjustment. This allows the choice of six colours and their brightness to be selected with the push of one button.



Run'N Drop Bite Detection. The alarms are able to detect running or drop back bites, whilst the receiver will alert you for a drop back bite with a dedicated led and sound.



Audible & Visual Replication. Each sound pulse and led flash from the bite alarm is replicated exactly at the receiver, thus to eliminate strikes on false triggering caused by the wind and water movement.



Ultra Long Range Signal. The Pulsar contains an advanced transmitter device, capable of long distances.



Easy Syncro. Synchronize the units to the receiver has never been so easy, just with the push of Syncro button on the receiver the unique identification code will be registered.



Multi-Channel Receiver. The receiver works with up to six different channels, so up to six units can be used at once.



Silent & Vibro Mode. The units can be set to silent mode without the need to switch-off, while the receiver can be set to "Sound", "Sound+Vibro" or "Vibration" mode.



Anti-Theft Function. When a Pulsar ADS is switched off it can activate an alarm warning in the receiver in case of attempted theft or battery failing, the same can be used as Range Test feature.



Integrated Snag Bars. The Snag Bars, supplied as standard in the sets, fit neatly into a dedicated rigid threaded slots moulded in the extra tough ABS case.



Energy Saver Circuit. The Pulsar are designed to reduce at minimum the battery consumption with advanced energy saver devices.



Low Battery Warning. The Pulsars continuously monitor the battery voltage and detects its failing with audible/visual warnings which are also transmitted where specified.



Induction Night-Light. The twin leds Night-Light glimmer continuously confirming that the alarm is switched on. The night-light brightness can be adjusted to be clearly visible in the dark.



Memory Function. The units and the receivers remember all personal settings when changing batteries or turning them off.



Weather-Proof Body. The Pulsars have been designed to be totally weatherproof and withstand to the most rigorous condition.



2 Years Warranty. Pulsars are supplied with a two years warranty terms as a standard.



Quick Release. The Quick Release system allows to easily remove the units from the buzzer bar. The rigid 3/8 thread and the locking nuts also allow infinite alignment adjustability for the facing position. If the Pulsar is not facing the desired position, unscrew it until you can reach the locking nut. Back the locking screw a quarter to half a turn, then screw the Pulsar back on.



PROTECTIVE COVERS



The alarms and the receiver included in the sets are supplied as a standard with their rubber protective cover thus to avoid damages during the transport.

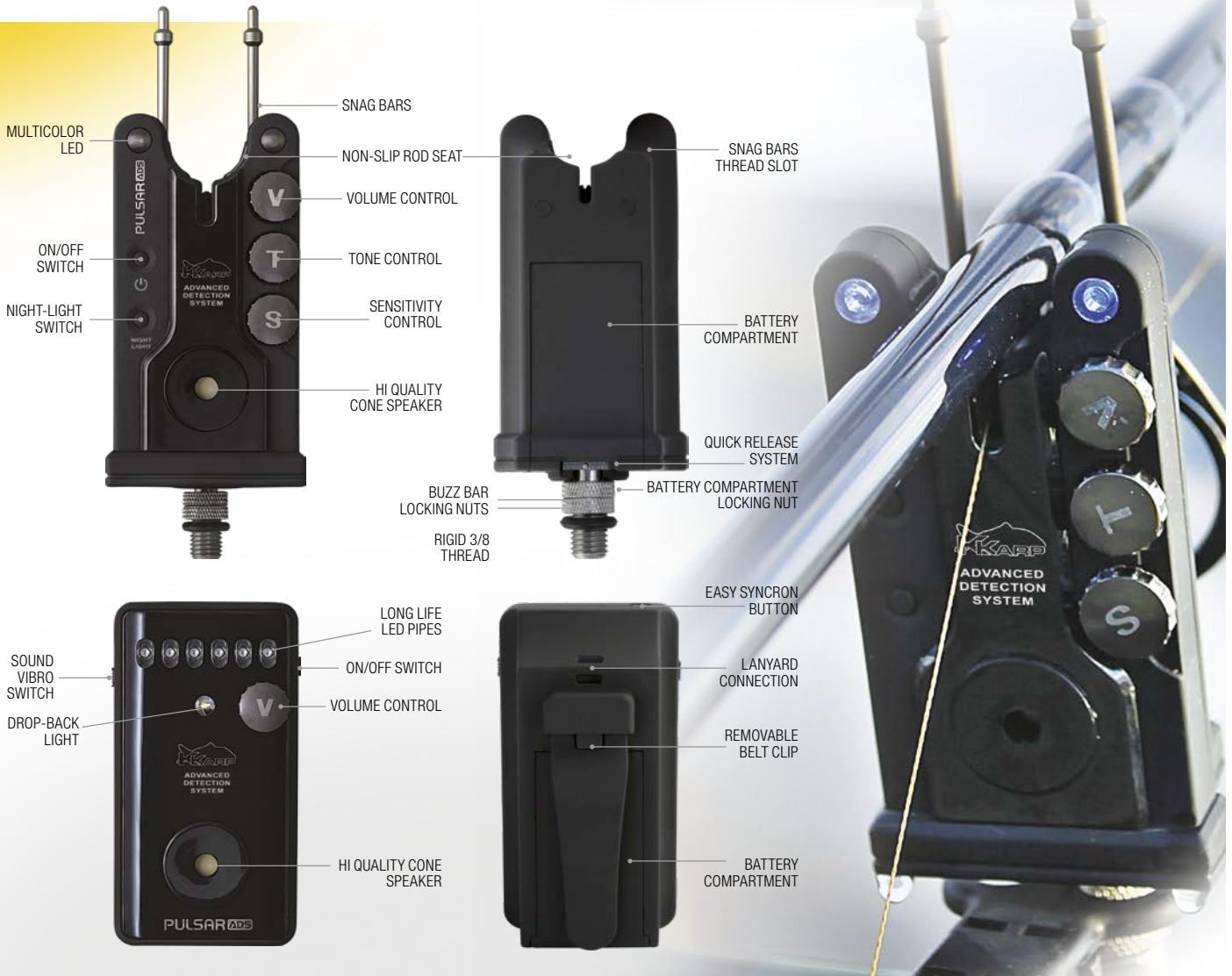

PULSAR ADS MINI

The elegant, handy case holds and protects the new, fantastic set of Pulsar electronic bite alarms and their dedicated receiver, forming a technologically advanced system. The first physical contact with rubber finish of each single component gives a pleasant sensation, but it's on the water that the satisfaction goes to the top, as soon as the system is activated, enabling the remote control of the situation, during the day as well as through the night, from an operating distance which is so long to enable to pay a visit to the other carpers around the lake. The system has been designed and engineered to cooperate with Pulsar ADS Lamp, widening the chances to take full advantage from these bite indicators. The set is available in two versions, for three or four rods, and comes already synchronized to wireless receiver, which is prepared to accept other indicators, thanks to the specific button located on top of the receiver's body. Being completely weather proof, the indicator's cases are ultra compact and include highly miniaturized circuits, which develop total precision and reliability.

019-27-200 Pulsar ADS Mini 3+1

019-27-210 Pulsar ADS Mini 4+1



Volume, Tone, Sensitivity & Wireless. Volume, tone and sensitivity can be adjusted by pressing dedicated controls, familiarise yourself with the controls before connecting the batteries.



Run'N Drop Bite Detection. The alarms are able to detect running or drop back bites, whilst the receiver will alert you for a drop back bite with a dedicated led and sound.



Audible & Visual Replication. Each sound pulse and led flash from the bite alarm is replicated exactly at the receiver, thus to eliminate strikes on false triggering caused by the wind and water movement.



Ultra Long Range Signal. Pulsar ADS Mini contains an advanced transmitter device, capable of long distances.



Easy Syncro. Sync the units on the receiver has never been so easy, just with the push of Syncro button on the receiver the unique identification code will be registered.



Multi-Channel Receiver. The receiver works with up to four different channels, so up to four units can be used at once.



Silent & Vibro Mode. The units can be set to silent mode without the need to switch-off, while the receiver can be set to "Sound", "Sound+Vibro" or "Vibration" mode.



Energy Saver Circuit. The Pulsars are designed to reduce at minimum the battery consumption with advanced energy saver devices.



Low Battery Warning. The Pulsars continuously monitor the battery voltage and detects its failing with audible/visual warnings which are also transmitted where specified.



Induction Night-Light. The led Night-Light glimmer continuously confirming that the alarm is switched on, the function can be easily switched On/Off by a dedicated button in front of the alarm.



Memory Function. The units and the receivers remember all personal settings when changing batteries or turning them off.



Weather-Proof Body. The Pulsars have been designed to be totally weatherproof and withstand to the most rigorous conditions.



2 Years Warranty. Pulsars are supplied with a two years warranty terms as a standard.



PULSAR ADS LAMP

The Pulsar ADS Lamp is surely the most advanced system of remote bite indication, designed to be connected with six indicators belonging to Pulsar ADS or Pulsar ADS Mini range. Its function is to receive the signal and automatically switch a large LED lamp, whose power consumption is so low to grant 80.000 hours of light. The emitted light has the same colour of the bite alarm, so that the indication contains also the information about which rod must be grabbed for the fight. The lamp can be hung inside the bivvy by the provided hook, or can be applied to any metal surface, thanks to the magnet included in the body. It can even be used as a normal illumination device, using the easy access switch located on the body's side.

019-27-300 Pulsar ADS Lamp



Multicolour Led Selection with Brightness Adjustment. This allows the choice of six colours and their brightness to be selected with the push of one button.



Easy Syncro. Sync the alarms on the Pulsar ADS Lamp has never been so easy, just with the push of Syncro button on the lamp the unique identification code will be registered.



Ultra Long Range Signal. The Pulsar contains an advanced transmitter device, capable of long distances.



Multi-Channel Receiver. The Pulsar ADS Lamp works with up to six different channels, so up to six alarms can be used at once.



Energy Saver Circuit. The Pulsar ADS Lamp is designed to reduce at minimum the battery consumption with advanced energy saver devices.



Low Battery Warning. The Pulsar ADS Lamp continuously monitors the battery voltage and detects its failing with visual warnings which are also transmitted where specified.



2 Years Warranty. Pulsars are supplied with a two years warranty terms as a standard.



DRAKE TX

High quality, ultra compact and reliable bite indicator sets. The latest cutting edge technology at your service.



- Run 'N' Drop Bite Detection differentiation
- Night Light Mode Option with low battery consumption diode
- Vibro & Mute Mode Selection to help you position your rods correctly without to be forced to turn-off your alarms
- Auto Detection System to easily sync your alarms and the receiver
- Bright high quality long-life LEDs
- Compact design
- Long Range Signal (100/150 m depending on conditions)
- Low Battery Consumption with Low Level Battery Warning
- Energy Saver ON/OFF switch
- Adjustable Sensivity & Volume & Sound
- Ultra Strong ABS Case with Soft Touch treatment
- Resin Coated Electronic Circuits
- Elements Resistant Speakers & Case
- Power Out Socket for Drake Hangers
- Detachable belt clip on receiver
- Receiver functions with 3x 1.5V AAA batteries and the alarms with 1 battery 9V(6LR61)
- Batteries not included

019-25-920 Drake TX Bite Alarm Set 3+1
 019-25-930 Drake TX Bite Alarm Set 4+1

DRAKE TX BITE ALARM SET

Advanced bite alarm for the most demanding angler. Designed with a shock resistant ABS shell and electronic components have been flooded into a thick resin foam to avoid problems with water and moisture. In evidence there is the Run'N'Drop function, producing different tones and different flash light if the carp is running away or coming in. Then we added a switch for activating or deactivating the night light. The electronic is supplied with Energy Saver technology, allowing to fully disconnect the battery circuit increasing its durability even under high humidity. Receiver range is field tested at 150 meters with perfect signal reception. The "Auto Detection System" automatically synchronizes the receiver with the alarms.



K-KARP BITE INDICATION SYSTEM



- Auto Night Light Mode Option with a low battery consumption diode
- Energy Saver technology with Ultra Low Battery Consumption
- Vibro & Mute Mode Selection to help you position your rods correctly without to be forced to turn-off your alarms
- Auto Detection System to easily sync your alarms and the receiver
- Bright high quality long-life LEDs
- Ultra-Compact design
- Long Range Signal (100/150m depending on the conditions)
- Adjustable Sensivity & Volume & Sound
- Ultra Strong ABS Case with Soft Touch treatment
- Resin Coated Electronic Circuits
- Elements Resistant Speakers & Case
- Power Out Socket for Drake Hangers
- Detachable belt clip on receiver
- Receiver works with 3x 1.5V AAA batteries (LR03)
- Alarms work with 3x 1.5V AAA batteries (LR03)
- Batteries not included

GLADIO TX MICRO BITE ALARM SET _____

Bite alarm equipped with the best electronic. The compact and minimalist design adapts to anglers demand, while inner electronic will surprise even the most expert anglers. Special feature is the "Auto Night Light", a small LED that turns on automatically when daylight is fading, so saving battery energy. Gladio TX features digital tone, volume and sensitivity control too, to always face the fishing conditions at best. The receiver self-synchronizes with the bite alarms thanks to "Auto Detection System" and can receive the signal even at long range, 150 m according to K-Karp team field tests. Both the receiver and alarms are equipped with "Energy Saver" technology to preserve battery life.

019-25-950 Gladio TX Micro Bite Alarm Set 3+1

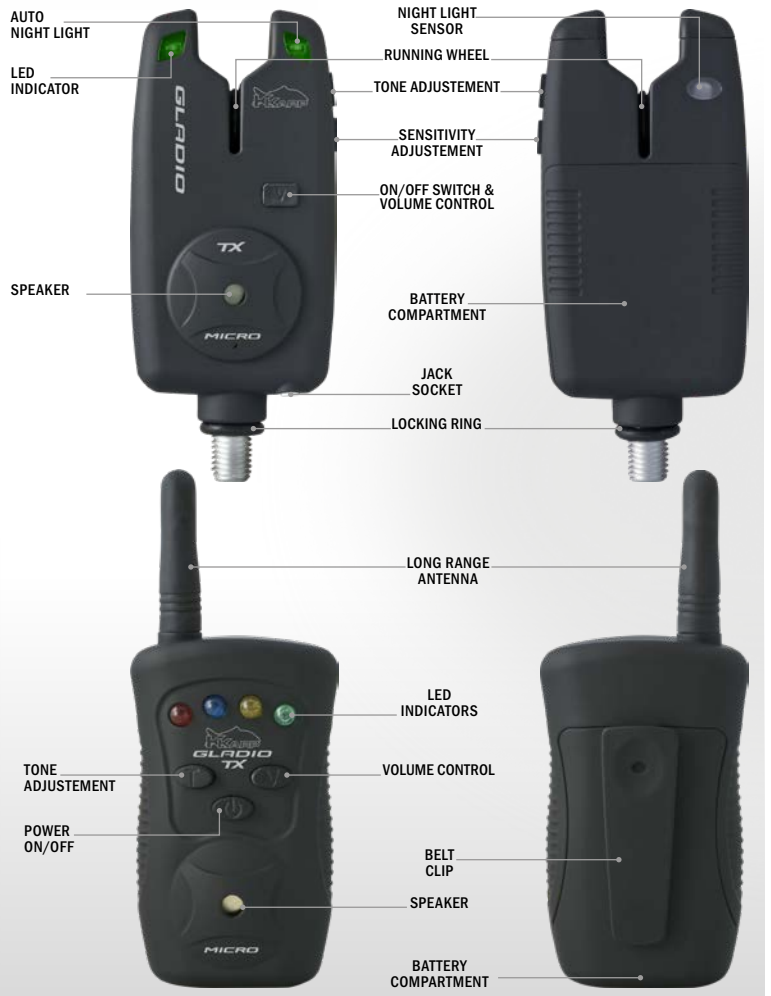

DRAKE XTR BITE INDICATOR



Recently improved, the Drake Plus Bite Alarm feature Nite-Glo LED and magnetic bite detectors. Compact and attractive shape with mat black soft touch finish. Internal electronic components have a special coating which protect from rain and humidity, and make possible to set in four different level volume, tone and sensibility. The led have 30 seconds memory and on the bottom there is an output jack where illuminated bite indicators can be connected. Available in four different colours: blue, green, yellow and red, it works with MN-ZN 9V batteries.

- Easily tuning thanks to four weatherproof buttons
- Four different adjustable grade of sensitivity
- Elements resistant speaker
- Nite-Glo sensitive led with 30 seconds (approx.) latching time
- Fully integrated system with Drake Hangers
- Magnetic rollers coated and shaped to increase friction
- Drop bite detection
- Resin coated electronic circuit
- Water resistant case
- Works with MN-ZN 9V batteries

019-25-901 Drake XTR Bite Alarm 9V Blue

019-25-902 Drake XTR Bite Alarm 9V Green

019-25-903 Drake XTR Bite Alarm 9V Yellow

019-25-904 Drake XTR Bite Alarm 9V Red

GLADIO BLACK HANGER SET

The Gladio Black Hangers are available just as a 4 rods set, to offer the angler a complete bite indicator set-up. The innovative self-tensioning line gate holds nylon or braid without danger of premature release even under brutal tight line tension, but releases cleanly on the strike every time. Whilst the 2oz sliding weight helps to cope with all conditions you may be facing. The Gladio Black Hanger set is available only with a stylish steel grey colour heads and comes in a neat, fully padded protective case. It plugs into all K-Karp Bite Indicator.



190-40-700 Gladio Black Hanger Complete Set 4pcs





DRAKE XTR STIFF HANGER

Drake XTR Illuminated Stiff Hanger is designed to face any situations, from long range as well as to short and medium range. It's fitted with a sliding weight to allow to adjust line tension. Drake XTR features a fully integrated, self-tensioning line clip, suitable for both mono and braided lines. The smooth rounded head ensures tangle-free operations. The fluorescent head features a led illuminating system, with 20" latching time. It plugs into all K-Karp Bite Indicator.

190-40-500	Drake XTR Stiff Hanger Complete Set 4pcs
190-40-510/5	Drake XTR Stiff Hanger Blue
190-40-520/5	Drake XTR Stiff Hanger Red
190-40-530/5	Drake XTR Stiff Hanger Green
190-40-540/5	Drake XTR Stiff Hanger Yellow



The 4 rods presentations set is provided as standard with a stylish zippered protective case.

DRAKE DROP HANGER

Suitable for short and medium distance use, these Drop Hangers feature fluorescent coloured heads and lighting system with 20 seconds memory. The line tensioning system is adjustable and is perfect for both braided and monofilament lines. The device lights up when the buzzer is activated and confirms whether the bite is a "run" or a "drop back". Available in four colours, Drop Hangers are compatible with all Drake Bait and Bite Indicator Alarms.

190-40-310/5	Drake Drop Hanger Blue
190-40-320/5	Drake Drop Hanger Red
190-40-330/5	Drake Drop Hanger Green
190-40-340/5	Drake Drop Hanger Yellow



BAIT BOAT

BAITING WITHOUT LIMITS

ARDITO



WATCH THE VIDEO



Baiting the target swim with the aid of a bait boat is the most effective way, not only for the reachable distances, but especially for the accuracy. In fact, the concentration of the loose feed in the selected point and in a restricted area pushes carp to compete for food, raising the chances of getting a bite and causing faster takes. This applies in the winter months, when volumes are necessarily low, but even at the height of the season, when significant amounts of food are released to draw the attention of big carp.





GARANZIA 24 MESI*

ARDITO BAIT BOAT

The K-Karp projects in the bait boat's field have always been at the highest quality level, and this new model confirms the image of reliability and efficiency gained through thousands and thousands of units currently serving the best carp anglers across Europe. The Ardito has the big responsibility to replace the old Black Queen, but it does the job exceeding its basic physical characteristics with a completely new design, which led to a smaller outer size in spite of the identical load capacity. The new concept has also reduced the total weight, with obvious benefits in terms of stress on the engines. The feed hopper system ensures the complete release of boilies, pellets, corn, seeds, while a light signal indicates that the operation was successfully completed. The hook clip is located in an area protected from any contact with the vegetation or debris on the surface, and is connected to a light signal that is activated by the release system itself. Quite interesting solution has been adopted for the upper shell, which is magnetized for easy removal at the end of the fishing session, to ensure complete drying at home and long lifetime of the equipment. Available as an option, the Fish Finder remote control allows to explore the aquatic environment in search of fish and underwater features, as well as checking the depth.

190-72-500	Ardito Bait Boat
190-72-400	Fish Finder

Solar Panels Recharger

The solar panels recharger allow to be completely independent during the long fishing sessions. It is enough a good illumination to allow the complete recharge of the batteries. For the maximum performance of the panels we advise to put them perpendicularly to the solar rays.

190-72-200	Boat Battery Solar Recharger
190-72-250	Car Charger

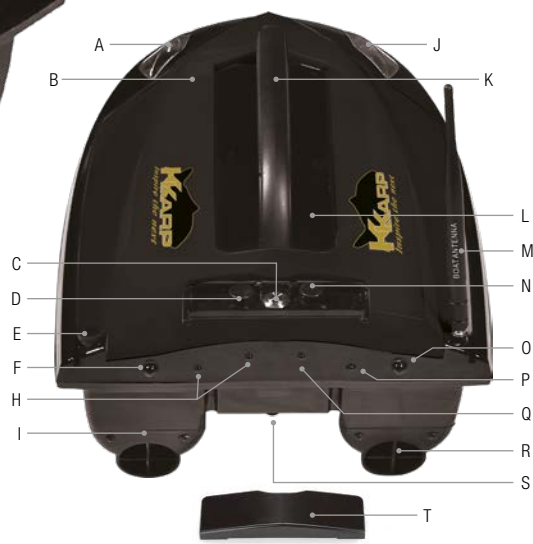

BAIT BOAT LEGENDA

- | | | | |
|---|----------------------------|---|---------------------------|
| A | Front light | K | Folding Handle |
| B | Upper shell | L | Bait hopper |
| C | Power switch | M | Boat antenna |
| D | Charging socket | N | Optional accessory socket |
| E | Fish Finder antenna socket | O | Signal light |
| F | Signal light | P | Bait release light |
| H | Battery capacity light | Q | Hook release light |
| I | Weed guard | R | Weed guard |
| J | Front light | S | Hook Clip |
| | | T | Magnetic cover |

Dimensions:	L470mm - W310mm - H250mm
Weight:	5.6kg – including batteries
Bait Tank:	1
Hoopers:	1
Bait capacity:	2kg approx
Maximum speed:	50-80meters/minute according to conditions
Electrical system:	12V DC
Range:	500 +/- meters depending on weather and environmental conditions
Radio handset:	4 channels, 2.4GHz
Lights:	2 front, 2 rear, 1 for the hook, 1 for bait door, 4 battery status
Propulsion:	2 independent propellers
Batteries:	2 x 6V/4.5AH lead-acid for bait boat, 8 x 1.2V rechargeable for the handset, 1500mAh 1.2V rechargeable battery for the remote control handset
Running time:	1.5 hours (at max speed)
Accessories:	1 pc 15V 1.2A home charger for bait boat 1 pc 12V 0.5A home charger for handset 1 pc antenna for bait boat Carry bag

*Visit our website to know more about the warranty terms and download the informative brochure.

SHELTERS

The whole K-Karp shelters production has been designed and tested to offer the best they can find on the market. The new shelters are equipped with the latest mounting systems and configurations that make them more versatile to face any condition.



ENEMY DOME

Innovative four season two-person bivvy. Preassembled frame made of 10 mm diameter aluminium poles ensures great stability even in extreme windy conditions. Despite the big size it is very easy to set up thanks to the "delta" side junctions; actually it is sufficient to peg the rear part and then pull forward the whole structure and you are done. Enemy dome is wide enough to accommodate two anglers and all the equipment they need, ensuring an exceptional insulation even in very challenging conditions. The outer sheet is made of HT tissue and can withstand a water column of 5000mm: even the most violent storm cannot produce such a quantity of water! Supplied with a frontal transparent window that can be obscured or substitute with a mosquito net in the warm season. Removable PVC floor. Supplied with pegs and carry bag.

FEATURES

- Frame Cover
- Removable Heavy Duty PVC Waterproof groundsheet
- Seams in 120G/SQM PE all heat welded
- Aluminium rings and tent pegs
- Adjustable Tension Poles
- 2nd door with mosquito net
- Aeration back window
- Central lantern hook
- Carrying bag

191-30-170 Enemy Dome

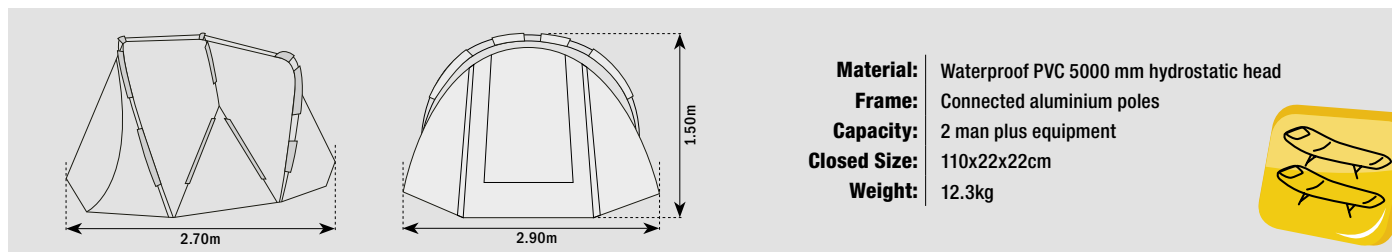

Material:	Waterproof PVC 5000 mm hydrostatic head
Frame:	Connected aluminium poles
Capacity:	2 man plus equipment
Closed Size:	110x22x22cm
Weight:	12.3kg





GLADIO ELEMENTS BIVVY

Born from a retro design shaped on the needs of the modern carp angler that requires speed, stoutness and practicality. The Gladio Elements Bivvy manages to combine the convenience of a bivvy, with the capacity of a dome, actually its generous measures can comfortably accommodate a bedchair plus all the equipment used for a fishing session, protecting an overnight stay comfortable during several days. The special aluminium poles creates an high structure so you can have extra space for better comfort. The front is protected by a small porch, for extra protection and a great comfort when raining, and it is big enough to keep the door open even during heavy rains. The cover is completely waterproof and can withstand a water column of 5000mm, offering a complete protection ; even the three windows are well protected. In any case it will be sufficient to remove their protection to turn them into a mosquito mesh for the warmer months. Speaking of warm season you cannot avoid to notice the rear windows, positioned to increase air circulation and cool the inner room.

On the front there are two special joints that hosts the poles and ensure complete blockage in an elegant and safe way, even in case of strong winds. In addition drives have been made in very tough and long lasting. Finally, the removable floor is made of sturdy PVC to allow fishing in those areas where the use of the floor is prohibited. Pegs and carry bag supplied.

FEATURES

- Frame Cover
- Removable Heavy Duty PVC Waterproof groundsheet
- Seams in 120G/SQM PE all heat welded
- Aluminium rings and tent pegs
- Adjustable Tension Poles
- Aeration back windows
- 2nd door with mosquito net
- Central lantern hook
- Carrying bag



191-30-220 Gladio Elements Bivvy

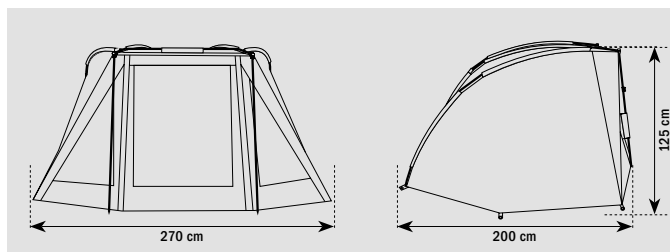

- Material:** Waterproof PVC 5000 mm hydrostatic head
- Frame:** Connected aluminium poles
- Capacity:** 1 man plus equipment
- Closed Size:** 148x20x15cm
- Weight:** 8.0kg



PUNISHER DOME

It has been designed by K-Karp team to actually contain two bedchairs plus a lot of tackle, this new bivvy which features the classic hinged frame which allows to set it up and fold it down in a few minutes. The main frame is made by strong tubular aluminium sticks, shaped and anodized to resist to stress and weather without risk of oxidation. The cover is made by a strong PVC sheet of 210 denier, coated to become fully waterproof and strong enough to bear 5000 mm of water pressure, an extreme condition which is not recorded in the weather statistics because is more than rare. All stitching are made from PE filament and then hot sealed to grant full safety and durability. The cover sheet's tension can be pulled to the maximum, thanks to the aluminium rings and pegs supplied with the product.

The main door and lateral windows feature the mosquito net, as well as both aeration windows located on back side, which are useful in summer season to keep the inside as fresh as possible. In the middle of ceiling, a hook is provided to hang the bivvy light. The groundsheet is made from strong PVC to resist from abrasion due to rocks hidden in the ground, and can be removed to easily wash it. The Punisher is supplied with a carry bag for easy transport.

191-30-230 Punisher Dome



FEATURES

- Frame Cover
- Removable Heavy Duty PVC Waterproof groundsheet
- Seams in 120G/SQM PE all heat welded
- Aluminium rings and tent pegs
- Adjustable Tension Poles and tent pegs
- 2nd door with mosquito net
- Aeration back window
- Central lantern hook
- Carrying bag

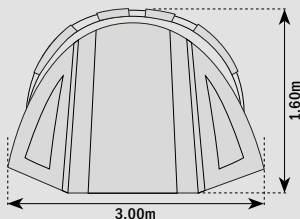
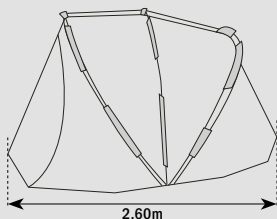

Material:	Waterproof PVC 5000 mm hydrostatic head
Frame:	Connected aluminium poles
Capacity:	2 man plus equipment
Closed Size:	185x25x25cm
Weight:	10.5kg





EXCELLENCE BROLLY

In addition to greatly expanded landscape tents range, K-Karp, decided to also introduce a brolly, able to withstand any weather situation. The Excellence, is dedicated to all Carpanglers, lovers of short sessions and mobile fishing, where a shelter for quick assembly, no doubt helps with the move. It has three windows with mosquito net, two on the sides and one on the main entrance, which also includes a transparent layer of PVC, ensuring excellent visibility. If necessary, all the windows can be covered to prevent excessive morning light. In summer, the front can be removed, transforming the Excellence in a convenient umbrella oval. The structure is remarkably robust and can withstand extreme conditions of wind and rain, thanks to four aluminium poles in that can be screwed directly on the ribs of the umbrella. Excellence has pegs with screw anchorage and includes the bottom tear-washable. The best solution for short fishing sessions.

FEATURES

- Frame Cover
- Heavy Duty Waterproof groundsheet
- Seams in 120G/SQM PE all heat welded
- 4 telescopic poles
- Zip-in removable front panel with doors
- Heavy Duty tent rings
- Tent Pegs
- Carrying bag

191-30-110 Excellence Brolly

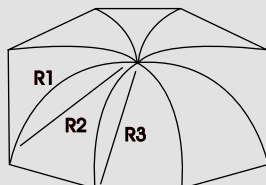
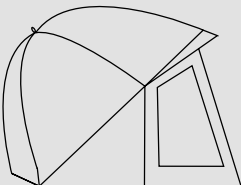

R1=1.50m
 R2=1.75m
 R3=1.25m

Material: Waterproof PVC 5000 mm hydrostatic head
Frame: Tilt opening system
Capacity: 1 man plus equipment
Closed Size: 183x15x15cm
Weight: 8.9kg



BIVVY BAG

Designed to carry a bivvy or an umbrella, this bag is made from 1200 Denier strong fabrics, and features Velcro handles plus a removable padded shoulder strap. Both ends display another handle, which are aimed to help extract the bag from the car's boot, when it is particularly stuffed of tackle. Two lateral zippered pockets are destined to contain pegs, strings and any other accessory of the bivvy.



		DIMENSIONS
193-30-500	Bivvy Bag	130x25x25 cm

HAMMER & PEG KIT



Kit with 10 stainless steel bivy pegs and hammer all in one bag. The pegs feature screw point and metallic head which allows to use them also in the hardest ground.

		DIMENSIONS
193-30-065	Hammer & Peg Kit	43x9x9 cm

POD LAMPS

Multifunction LED lamp, created to accompany the carper. It can be used as a hand torch or it can be turned into a handy and stable tripod. The Large model, works with 3/9 AA batteries, and is used in open spaces, the Compact which uses 1/3 AAA batteries fits perfectly in the tent to facilitate any operation.



190-51-020	X-Large 5 Leds
190-51-025	Compact 3 Leds

PIONEER TABLE



Large aluminium table, suitable for rig making during long fishing sessions. Designed with raised edges and adjustable telescopic legs. It is a steady flat space for your keys, mobile phone, cups etc. It is coated with a strong paint which is heat and crackling resistant. Legs can be closed again easily and it is equipped with a bag for transport.

		DIMENSIONS
191-20-050	Pioneer Table W/Bag XL	50x30x16.5x23 cm

PULSAR MOVEMENT SENSOR LAMP

Lamp equipped with night movement detector. Thanks to this innovative lamp you will have no more problems and you will find your shoes or clothes during the exciting moments when the bite alarm starts screaming in the middle of the night. It will be sufficient your movement to turn the lamp on. It can eventually be used as a common lamp using the switch.



190-51-050	Pulsar Movement Sensor Lamp
------------	-----------------------------



BANDIT SLEEPING BAG



Sleeping bag dedicated to mid-season and the summer with internal fabric in soft, warm micro fleece. The outer shell, breathable, prevents condensation, leaving the body dry. Despite the large size (230X90 cm), attaches easily to the bed through the pockets and adjustable

belt. Comes with handy carrying case in which, when folded, occupies a minimum size. The measures are in fact held 45x25x25 cm.

191-15-120	Bandit Sleeping Bag	DIMENSIONS 230x90 cm
------------	---------------------	--------------------------------

REACTION COVER BLANKET



Usually you don't use the same sleeping bag and not always the same sleeping bag is sufficient to face the lower temperatures. For this reason the K-Karp Team wanted to create a new blanket to face all the needs of carp fishing. Actually the Reaction Cover has been mainly designed to face Summer nights, as a simple shelter, but it fits perfectly as a blanket when you are sitted outside waiting for a carp bite during a cold autumn day, and finally found a specific use

to enhance the thermal barrier of your sleeping bag during the cooler nights. Breathable outer cover, breathable hollow fibers padding and soft polar fleece inner part are the main data to define a key element for the most demanding angler! All around it there hooks to lock it to the bedchair.

191-15-140	Reaction Cover	DIMENSIONS 230x140cm
------------	----------------	--------------------------------

CHAIRS

The good quality relax, while our baits are doing their job, is the key to be quick and fit in the moment of the truth, when the most loved alarm will wake us up.



PUNISHER BEDCHAIR

Punisher is a particularly comfortable bedchair, featuring six legs, of which four are adjustable in length. All feet are designed with wide diameter to avoid digging into the mud and to protect bivvy's groundsheet from any damage. Their bottom end is tilting to automatically adapt to the ground profile. The frame is fully built from tubular aluminium, to provide lightness and strength at the same time. The cover is made from breathable fabrics, while the pillow is well padded

		DIMENSIONS
191-10-470	Punisher Bedchair	210x82x38 cm



BEDCHAIR BAG

Very practical bag in waterproof, anti-tear strong fabric 1200D for packing away the bed at the end of a session. The length of the padded shoulder strap is adjustable for easy transport. The bag also has ergonomic handles, a reinforced main zip and specially reinforced seams to make it long-lasting over time. This bag can comfortably hold any of the K-Karp chairbeds.

191-15-040 Bedchair Bag



ANTIDOTE BEDCHAIR

The K-Karp team, after years of experience and field tests, designed this new bedchair that can be offered at an affordable price.

The Antidote Bedchair is absolutely an high quality item but you don't need to spend too much to have it. The aluminium frame features six legs, using the Fast Lock System and fully adjustable anti mud feet. All the feet are soft rubber coated to prevent any damage to the floor of your tent. The bedchair padding is over 5 cm thick in all the parts that need to support your body when laying and it is entirely covered in High Impact fabric, a really strong and long lasting material. The overall structure is

really strong and can accept XXXL carp anglers. The backrest, featuring a neoprene pillow, can be adjusted through a big knob.

		DIMENSIONS
191-10-420	Antidote Bedchair	225x95x40 cm

BANDIT CHAIR

This chair is the K-Karp answers to the many requests coming from the more extreme carp anglers, people who is fishing all the year long. The aluminium light weigh frame allow an easy transport even for long ranges, and the adjustable legs and feet make it suitable for every ground. The Bandit chair uses the new Eazy Lock system, a very very fast way to adjust the chair with just one act and avoiding to screw and unscrew for minutes. Padding is 3 cm thick and fabric is made of 600 deniers. Some members of the K-Karp Team have even spent the whole nights fishing on the Bandit thanks to its high level of comfort.

		DIMENSIONS
191-10-330	Bandit Chair	61x55x68/102 cm



CHAIR BAG

Practical bag made in tear-proof, waterproof strong fabric 1200D for packing away the chair at the end of the session. The length of the padded shoulder-strap can be adjusted for easier transport. The ergonomic handles, reinforced main zip and reinforced seams ensure it will be long-lasting over time. This bag can easily contain any of the K-Karp chairs (apart from Mesh Fold and Easy Chairs that come with their own carry-bags).

191-15-050	Chair Bag
------------	-----------



CHAIRS & BEDS POUCH

Convenient pocket to be applied to the chair or bed-chair. It can be used with all products, not just with K-Karp. Enables the angler to store all the objects that should not become dirty or just to have them handy.



		DIMENSIONS
191-15-100	Chairs & Beds Pouch	40x24 cm



TOURER MKII CHAIR

It's more than a common carp chair, as it doesn't limit to hold the user, but goes further and assists him with some useful accessories. Apart from the arm rests, it offers a practical adjustable rod rest, plus a wide accessory tray. All legs are adjustable and feature tilting mud feet. The seat is made from waterproof fabric, while the back rest is padded.

		DIMENSIONS
191-10-480	Tourer MKII Chair	43x47x31/73 cm

BEDCHAIR FEET COVER

This cover protects the bedchair feet from mud, sand and dirt in general to prolong the life of the chairbed. Made in waterproof, anti-tear material, it can easily be washed.

191-15-030	Bedchair Feet Cover
------------	---------------------

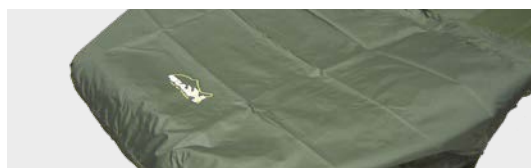

LUGGAGE & HOLDALLS

SHARING PASSION QUALITY

The K-Karp Team is committed to re-searching the best materials from years, to produce what's probably the best range of luggage now available.

Materials, solutions and fabrics are chosen by carpers who really live on the banks and know what carp fishing is. The sharing of our passions has let us designing quality products, improve functionality and durability and to suit your own individual requirements, non-just on the banks but also logistically when you need to pack and transport them. Through the whole range you'll find we utilized only tear and water-resistant treated polyester, lightweight but extremely durable, strengthened and sturdy zips to withstand extreme use, strengthened scuff pads and stiffened and padded handles to help the transport and to spread the load for the maximum comfort! We're proud to share our passions, experiences with other carpers and that's possible through our luggage range.



DESIGN



Designed to offer maximum load capability, functionality and comfort, by our Team Members and produced to the highest standard.

FABRIC



Tear and water-resistant treated polyester, used throughout the range is lightweight but extremely durable.

ZIP

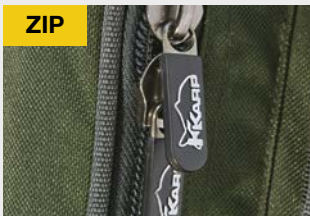

All zips through the range are specially strengthened and sturdy to withstand extreme use.

HANDLES



Stiffened and padded handles help the transport and to spread the load for the maximum comfort.



GLADIO MAX RODS HOLDALL

The number of carp anglers that decide to take long vacations on the lakes or to perform never ending sessions, is increasing every year. That's why we decided to build a holdall that can really carry 6 rods with reels with the same protection of a single padded sleeve. We know pretty well how much an angler loves his tackle, so we rejected any compromise in terms of quality and created a super high end holdall. If the protection grade of an holdall would be measured on a scale, the Gladio Max Rod Holdall would be at the top!

So our new rod holdall features six rod posts for 6 complete rod+reel sets, and two external side pockets that can be used for pegs or umbrellas. The inner posts are all individually padded to avoid any contact between the rods and the reels, even for big pit reels. It can be used both with 12' or 13' rods.



EXPEDITION 3/5 ROD HOLDALL
 21.5x33 cm



INTREPID 3 ROD HOLDALL
 21.5x33 cm



EXPEDITION 3/5 ROD HOLDALL

Expedition is designed for expert carpers. It can hold up to 5 rods and is extremely versatile. Totally padded to provide full protection, it has been tested with over 60 kilos weight. Equipped with 2 very roomy outside pockets and an aluminium tube for internal support. The bottom is reinforced with artificial leather to protect it against stones and gravel. Straps have a special anti-slip lining and are designed to stay in the centre of the shoulder when the bag is being carried. It is one of the most hi-tech rod bags on the market, designed for carpers and offered at an extremely competitive price.

193-00-000 Expedition 3/5 Rod Holdall



INTREPID 3 RODS HOLDALL

Designed for expert carpers, this holdall provides perfect protection for rods and reels during transport. The position of the straps and handles balance the bag to make carrying easy. The materials used have been tested and selected to be hard-wearing and resistant to all the strain a carper's equipment is subjected to. The Intrepid 3 rods is padded throughout to completely protect the 3 rods. The inside has a waterproof lining, so it can be easily washed and is not damaged by carrying wet or damp equipment. The Intrepid 3 has been tested with loads of over 50 kilos, so it is guaranteed reliable and long-lasting over time.

193-00-010 Intrepid 3 Rods Holdall



PIONEER 3 ROD HOLDALL
 155x28 cm



GLADIO 2 RODS HOLDALL
 200x24x22 cm



OVATION 3 ROD HOLDALL
 195x40 cm



PIONEER 3 ROD HOLDALL



The Pioneer rod holdall has been developed from the need to accommodate your three sections rods, both the 12" and 13". The materials used have been thoroughly tested to be hard-wearing and above all, strong. For this purpose, we opted for a tear-proof, waterproof 1200D strong fabric with PVC. We also added double padding, reinforced straps, zips and seams, protected, waterproof bottom, safety catches and a padded and anti-slip handle.

193-00-080 Pioneer Rod Holdall

GLADIO 2 RODS HOLDALL

Designed for short sessions and stalkers, Gladio is able to carry and protect two assembled rods and reels. Well-padded throughout, the rod sleeves have large reel pouches which will easily accommodate Big Pit reels as required. The heavy duty zip is situated on the opposite side to the reel pouch to prevent any possibility of catching the line during transport. Able to carry rods up to 12'6".

193-00-090 Gladio 2 Rods Holdall

OVATION 3 ROD HOLDALL

Holdall suitable for transportation of 3 rods with reels whose original structure has been designed for practical anglers. The inner part of the holdall, that can host 12' or 13' rods, has a lamellar frame that separate the blanks avoiding any friction. Three additional sleeves have been included inside, to be used as an extra protection for each rod. The holdall is padded in all the strategic points, such as on top, to increase the protection action.

193-00-130 Ovation 3 Rods Holdall



EVASION PRO DESK BAG

New rigid bag designed for long fishing sessions. With its 70 liters capacity it can carry a large amount of equipment, hardware and bait. It is possible to use it as a table because the inner space is protected by 4 metal ribs that make it extremely solid. Designed for the transport with trolleys, it is provided with a rich endowment which includes 1 K Box Rig Storage SL, 4 Accessory Boxes and 8 bait jars. PU molded washable bottom, removable molded cover, the two side pockets contain the jars while the front pocket carries the K-Boxes. EVA handle and padded non-slip shoulder straps.

	DIMENSIONS
193-20-080 Evasion Pro Desk Bag	63x34x35 cm

EVASION DESK CARRYALL

Developed in cooperation with everybody at the K-Karp Team, the Evasion Desk provides a volume of 55 lt and it therefore ideal for short sessions. The hard Eva top made is completely removable through a reinforced zip and can be conveniently used as a lap support for rigs building. If kept into position on the bag, it provides a solid base of support. The bottom is made of PVC and waterproof, as the whole bag is, ensure maximum protection also to the most demanding carp anglers. Three large side pockets, optimized for K-Boxes, complete this versatile carryall.

	DIMENSIONS
193-10-130 Evasion Desk Carryall	50x33x34 cm



EVASION DESK ORGANIZER

The smallest Desk Bag of our line, ideal for transporting small quantities of ready-made boilies, accessories and parts or as a reserve bag. Once again the inner space has been optimized to host our K-Boxes, while the hard top provides a solid base of support. The opening front zip is very practical and allows direct access to the contents without removing the objects resting on the lid. Waterproof and tear-resistant, reinforced double slider zips.

	DIMENSIONS
193-20-100 Evasion Desk Organizer	28x28x35 cm





GLADIO RUCKSACK 70LT

Special rucksack designed for stalkers, medium sized with 70 liters capacity. Equipped with 3 external pockets, additional pocket with Unit Box, extra padded shoulder straps and sturdy base, covered in non-slip PVC. Made in tear resistant double stitched material, as for all K-Karp luggages. Very comfortable.

		DIMENSIONS
193-20-045	Gladio Rucksack	40x30x61 cm



SUPREME STALK RUCKSACK 50LT

Superior capacity rucksack dedicate to the stalking. The structure is divided in 7 different spaces for different purposes. The central big space, that can be split, is huge and can really contain a lot of stuff, for sure everything you need for a whole day of fishing; in the front part there two large pockets, one holds a large plastic tackle box, the second one is empty and can be used to cram bulky stuff. The right side is set up to host some pegs, useful for sessions where you need to change very often your position, while the left side displays a document holder. Back and shoulder straps are fully padded and breathable, to grant the maximum comfort for long and arduous journeys, even during Summertime. The Supreme Stalk Rucksack is the perfect fellow for a dynamic style of fishing, offering great comfort and ergonomic.

		DIMENSIONS
193-20-110	Supreme Stalk Rucksack	36x26x54 cm



STALK SHELL RUCKSACK

The Stalk Pro Organizer has been designed for carp stalkers or lovers of short sessions, anglers who need to have everything at hand in a practical, multifunctional and spacious bag. The bag contains a table with adjustable legs for rig construction, a large central pocket where to store the Unit Boxes and other bulky equipment. In the front pocket there are 3 Accessory Boxes and a Rig Box SL. The padded back and shoulder straps provide extra comfort. Shoulder straps, if not used, can be stored in a dedicated pocket.

		DIMENSIONS
193-20-040	Stalk Shell Rucksack	50x40x20 cm





GLADIO STALK BAG

Very practical bag that can be carried as a backpack or shoulder bag, designed for the stalkers who love to travel frequently in search of their prey. The middle section opens like a book and it is divided into three modular parts, where you can arrange the material as you prefer. The shoulder straps when not in use can be stored in a dedicated pocket, while the bottom base is made of waterproof PVC. Made with no tear material and double stitching.



193-30-330 Gladio Stalk Bag

DIMENSIONS
46x15x40cm



PATRIOT EVA 100LT CARRYALL

Bag with very capacious main compartment plus two side and one front pocket. The fabric is anti-tear polyester and all seams are double to make it strong and hard-wearing over time. The bottom is in high density EVA with a strong zip to give access to more storage space. Ideal for carrying bulky equipment or accessory boxes, which can be comfortably arranged inside for transport. Loading equipment is made easy by the wide access to the main compartment. Straps are well-padded for maximum carrying comfort. Mud and dirt are easily washed off the EVA bottom.

193-20-020 Patriot EVA 100lt Carryall

DIMENSIONS
44x67x33 cm



FRONTIERS MKII EVA 60LT CARRYALL

Frontier 60lt EVA is a medium size bag that can hold a lot in its top-opening spacious inside compartment. Equipped with three big outside pockets designed to hold all the accessories and odds and ends normally stored in accessory boxes. The bottom in high density EVA protects the bag from damage and wear by stones and gravel, and opens completely to form a handy compartment for more accessory boxes. The top of the inside compartment is equipped with elastic cords to hold other equipment or accessories. With its space optimizing design, this is a bag that will amaze you for its capacity and practicality.

193-10-000 Frontiers MKII EVA 60lt Carryall

DIMENSIONS
36x52x33 cm

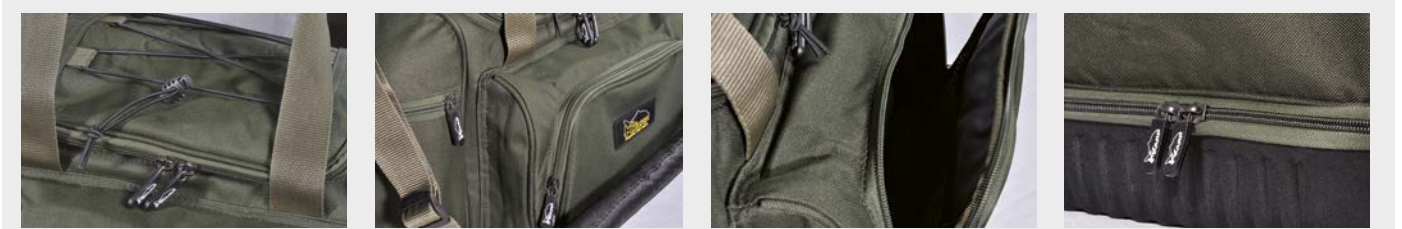



ATTRACTION MODULAR CARRYALL



A great bag designed for the serious angler, who spends long fishing sessions in search of the record carp. The product is not only great in sizes, but also great in versatility, considering that the user's needs can vary according to seasons or to fishing spots. The main characteristic is the modularity: four squared pockets, applied externally by Velcro bands, can be removed on the basis of the space requirement, up to make the bag completely naked. Since they feature handles, those pockets

become individual bags. Fully made from a strong and waterproof 1200 Denier fabric, the bag has stiff and waterproof top and bottom. Sizes of main compartment: 60 x 30 (h 36) cm.

		DIMENSIONS
191-15-075	Attraction Modular Carryall	82x42x36 cm



GLADIO COMBI CARRYALL

Convenience, efficiency and organization, we can summarize with these words the Gladio Carryall. The book style opening design and the three large internal pockets with independent zippers, allow you to have all the material on hand, ordered and distributed as needed. The upper and lower parts are waterproof and built in a rigid anti shock and waterproof EVA shell. The tear-resistant, waterproof material, coupled to the padding material delivers maximum protection. High load carrying capacity of 84 lt.

		DIMENSIONS
193-10-120	Gladio Combi Carryall	59x31x46 cm

PIONEER HARD CARRYALL

This Hard case has been developed by our team for the tackles transport during long sessions, and so it is able to withstand all environmental conditions. The upper and lower parts are waterproof and constituted by a rigid EVA shell, anti-shock and waterproof. The cover is completely removable thanks to a large perimeter really indestructible zip. On the front there is a practical zip allowing to access the inner space without having to remove the whole cover. There are also two convenient side padded pockets for storing accessories, while the inner space are optimized for the use of K-Boxes.

		DIMENSIONS
193-10-110	Pioneer Hard Carryall	62x31x42 cm





MEAL SET

Meal Set contains high quality tableware and is designed for maximum functionality in minimum space. The envelope contains 2 melamine plates, a towel, 2 stainless steel knives and forks and a cheese-knife. This is an essential accessory for carpers who love long fishing sessions and want the maximum comfort and practicality for their "spot".

193-50-000	Meal Set	DIMENSIONS 27x27 cm
------------	----------	-------------------------------



CAYENNE MEAL BAG

Bag equipped with a food set for two persons, made of sturdy 1200D washable strong fabric. The main compartment, easily accessible, is thermal and contains 3 food boxes, a cooler for drinks with screw cap, salt and pepper jars, napkins, cutlery and glasses.

193-50-090	Cayenne Meal Bag	DIMENSIONS 22x15x28 cm
------------	------------------	----------------------------------

AIR-DRY BOILIES BAG

Mesh cases essential for the maintenance of the anglers baits. They are ideal for storing ready made boilies especially if they are "non preserve-baits", the preservative ingredient can often lessen the effectiveness of any type of bait.

For this, we studied these mesh cases to maintain adequate ventilation and avoid harmful mould. They are available in two sizes.



193-30-165	Air-Dry Boilies Bag Small	DIMENSIONS 26x26x9 cm
193-30-166	Air-Dry Boilies Bag Large	DIMENSIONS 36x36x11 cm

WALKER

THERMIC BAG & BOTTLE SET

Practical container for carrying and storing drinks. Made in a special isothermal material that keeps the temperature of the bottle constant for a long time, whether hot or cold. The bottle included has a double pouring system.



193-50-040	Walker Thermic Bag & Bottle Set
------------	---------------------------------

CRUSADER COOLER BAG

For the transport of bait or food, K-Karp suggests this essential, strong and compact cooler bag. Made from strong and water-proof 1200 Denier fabrics, include a main compartment, whose walls are padded to keep the inside temperature as much stable as possible, plus a front pocket, destined to contain accessories, catapults, etc. Two side mesh pockets complete the available rooms, while both handle and shoulder strap for transport are well padded.



193-30-480	Crusader Cooler Bag	DIMENSIONS 30x24x27 cm
------------	---------------------	----------------------------------

ORGANIZER COOLER BAG

Cooler bag with zip that allows the lid to be opened just partially to prevent changes in temperature. Two removable trays with eight screw-top containers. The compartment can contain 4kg of boilies plus the trays. Shaped EVA base protects the bottom of the bag and holds the large Unit K-Karp drawers for small objects. Inside and outside pockets can hold a lot of accessories for baiting.



193-50-055	Organizer Cooler Bag	DIMENSIONS 29x30x20 cm
------------	----------------------	----------------------------------

PIONEER PRO AIR DRY

Bags for lovers of self-made, developed in collaboration with our testers. The Pioneer Pro Air-Dry rubber mesh allows the correct aeration and conservation of self made boilies, avoiding loss of effectiveness and the formation of mold. The mesh is also ice friendly, thus allowing you to put your boilies into freezer without removing them. All zips are reinforced and have the double slider. An additional and very practical pocket positioned on the bottom allows you to draw the required quantity of boilies in a few seconds.

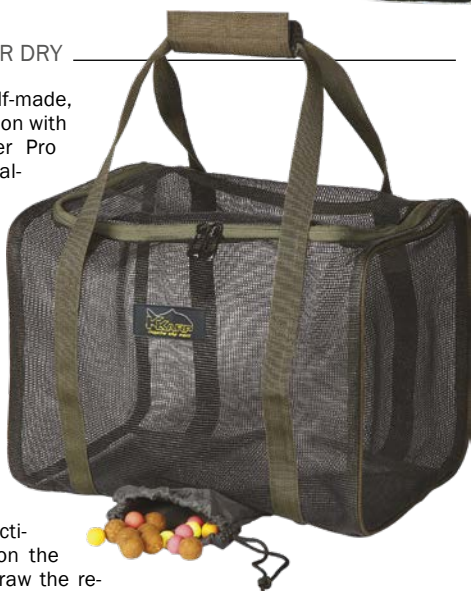

		DIMENSIONS
193-30-360	Pro Air Dry Small	25x23x24 cm
193-30-370	Pro Air Dry Large	35x25x26 cm

METHOD & BOILIES BAG

Bag designed for storing boilies or mixing and storing method groundbait. The thermic padding ensures proper preservation both during winter and summer sessions. It is also equipped with a rigid bottom and washable interior. It can be squeezed closed with the zips to take up very little space. The cover zips shut to protect the contents from rain and sun. Once shut it takes up just 8cm.



193-30-170	Method & Boilies Bag	DIMENSIONS 27x30 cm
------------	----------------------	-------------------------------

CAYENNE ORGANIZER PLUS

Rigid utility bag designed with two sections, one of which contains 9 jars suitable for the transport of boilies and the other is equipped with an EVA table suitable to contain a number of rigs and a section where are accommodated 3 boxes to organize small tackle. Stylish and made of 1800D strong fabric, enables secure protection and easy transport.



		DIMENSIONS
193-30-340	Cayenne Organizer Plus	30x24x15 cm



BAIT BAGS K-KARP

Bag for carrying Boilies and other bait sensitive to direct sunlight. In the 8 tub model, the two separate compartments hold 4 acrylic tubs each and are totally knock-proof. A description of the contents of each tub can be written on the plastic lid with special pens that can be cleaned off quickly with a damp cloth. The bottom is in artificial leather with anti-slip inserts. In the 6 tub model, the tubs are arranged in a single layer and separated by removable dividers.



		DIMENSIONS
193-30-010	8 Cans Bait Bag	44x33x33 cm
193-30-000	6 Cans Bait Bag	28x15x8 cm



LUGGAGE & ACCESSORIES BELT

Padded, adjustable belt for use on all K-Karp and other makes of bags and rod holders.

193-10-080	Luggage & Accessories Belt
------------	----------------------------

PIONEER RIG BAG

This small bag is designed to carry rigs and the equipment necessary to make them. It's equipped with two EVA pads, removable for ready rigs, while the space is specially adjusted to contain the K-Karp Accessory Box from 2-3 and 4 compartments. The lid has two pockets and an elastic band to contain scissors, knot puller, etc..

	DIMENSIONS
193-30-210 Pioneer Rig Bag	35x21x8 cm
193-30-215 Pioneer Pro Rig Bag	35x21x8 cm



2 SIDE RIG BAG

This new organizer have two different storage side both equipped with heavy duty zipper. In one side we put an high density EVA board and PVC bags where you can store a big number of ready rigs and accessories, in the other side you can find one K-Box Unit with removable dividers that can hold all the accessories required for the construction of new rigs.

	DIMENSIONS
193-30-245 2 Side Rig Bag	26x24x16 cm

CAYENNE WALLET ORGANIZER

1200D strong fabric wallet equipped on one side with a K-Boxe Rigs Storage SL, to hold your ready to use hooklinks, and on the other side with 4 Accessory Boxes, removable and customizable, designed to contain all the tackles you need to build your rigs. Double slider zip.

	DIMENSIONS
193-30-350 Cayenne Wallet Organizer	36x12x6 cm





PIONEER PRO RIG WALLET

We added to our luggage offer a new small bag for ready rigs, small but still able to contain more than 50 ready rigs. The inner part is divided by a divider that can be used to store small tackles, such as swivels, needles and pins.

	DIMENSIONS
193-30-235 Pioneer Pro Rig Wallet	32x21x5 cm

ZIG RIG BAG

A clever rig container, made from a high density EVA cylinder, around which the rigs are wound, to be then fixed by the pegs supplied with it. Everything is stored inside a nice bag, tailor made from strong and waterproof fabric. Consequently, the protection is total: no chance for UV rays to reach the rigs, nor for rocks or any other object to hit and damage them. The EVA element can be opened from one end and small accessories and components can be stored inside of the tubular core.



	DIMENSIONS
193-30-470 Zig Rig Bag	24.5x10 cm

FIREFOX K WALLET

With this rigid bag covered in 1200D strong fabric, you can store all the small items you need to tie your rigs, and thanks to the EVA rigid rig board you can store a good number of ready rigs.

Three Accessory Boxes with two, three and four compartments are included.



	DIMENSIONS
193-60-045 Firefox K Wallet	30x13x6 cm

K-BOX UNIT BOX

A very convenient box, purposely designed to easily store and protect many, many ready rigs; it's extraordinarily handy and very much practical. Produced from strong yet light plastic, it's shaped to be actually rain proof and can be opened and closed by efficient clips. Inside, six EVA boards with 12 pegs each can hold as many as 72 different sort of rigs, certainly more than enough for any expert carper, but also for the advanced feeder guys, who often face more variations in fishing conditions, compared to the carp scene. Thanks to its compact shape and size, the box can be stored in any carry bag pocket. Sizes of closed unit: 25x9x4,5 cm.



	DIMENSIONS
190-74-300 K-Box Unit Box	25x9x4.5 cm

UTILITY BAGS

FISHING EQUIPMENT 19|20



RIGS WALLET DOUBLE

Double rigs wallet with two EVA pads complete with stops and handy steel bars to hold hooks. Pins allow rigs of different lengths to be stored. Dimensions: length 40 cm, width 14 cm and thickness 4 cm.

	DIMENSIONS
193-30-035 Rigs Wallet Double	40x14x4 cm

RIGS WALLET

Another rigs wallet with 24 hooks on two EVA pads with two handy steel bars for hanging hooks. Dimensions: height 29 cm, width 14 cm and thickness 4 cm.

	DIMENSIONS
193-30-030 Rigs Wallet	29x14x4 cm

PIONEER PRO-BUZZ BAG

We all know how important is to store our buzz bars with the alarms mounted on. That is why we designed a bag that could protect the alarms in best way possible. A thin and padded divider separates the front buzz bar from the back one, while useful inner pockets can host small tools, tackles and tool kits.

	DIMENSIONS
193-30-115 Pioneer Pro-Buzz Bag	72x20x10 cm



CAYENNE ACCESSORY BAG

Fully padded bag, designed to store all the tackles that can be useful during the fishing sessions. It is the ideal bag where to put all the stuff that normally you need but that it is spread in 2 or 3 other bags. Perfect for short sessions when it can replace bigger carryalls. It can also be used as a beauty case to store all the stuff for the personal care.



	DIMENSIONS
193-30-430 Cayenne Accessory Bag	25x15x19 cm

WAIST BAG

Another version of the waist bag for personal accessories. This bag has a large main section, a zipped outside pocket, two side pockets to hold bottles or boilers, an elastic cord in front of the outside pocket for accessory boxes. Can be fastened round the waist with the quick-release adjustable strap or worn on the shoulder.



193-30-100 Waist Bag Small

CAYENNE RIG BIN

Useful cylindrical hard case for all the carp anglers. The external stiff hard case is the perfect protection for the rigs, while the inner HDE (High Density Eva) tube allows to wrap carefully all the hook lengths, whatever the length. It can be really useful when storing rigs such as the chod, granting the fluorocarbon line the correct bending. The inner cylinder is hollow and can be used to store some tackles such as needle or other useful small items.



	DIMENSIONS
193-30-420 Cayenne Rig Bin	Ø10x24 cm

FIREFOX RIG WALLET

High quality rig wallet, made following the high level standard of the Firefox range. Heavy duty cordura green lining and non slip Neoprene handle.



	DIMENSIONS
193-60-070 Firefox Rig Wallet	30x25x5 cm



CAYENNE LEAD BAG



Leads are an important part of the anglers equipment. If stored in the wrong way they can be spoiled and consequentially more visible to the carp. The Cayenne Lead Bag is the best way to store them, cause it is fully padded, keeping a transparent robust window on the front, allowing us to check the materials inside. The bag is available in two sizes and it is equipped with a carrying handle and an heavy duty double zip.



		DIMENSIONS
193-30-400	Cayenne Lead Bag	18x13x7 cm
193-30-410	Cayenne Lead Bag XL	26x18x7 cm



SPOOL CASE

The protection and transport of reel's spools, filled with fresh line and ready to be used, requires a certain care because the line damage can cause a fish lost. Also this problem has a solution at K-Karp: the specific container made from strong and waterproof fabric, closed by Velcro bands and supplied with internal partitions. The Spool Bag is wide enough to even contain the size 12000 spools.

		DIMENSIONS
193-30-490	Spool Bag	28x10 cm

SPOOL & REEL CASE

Reel Case designed by the K-Karp Team to hold and protect a reel with two spare spools. The anti-tear, waterproof 1200D strong fabric together with the padded interior keep the reel safe from knocks during transport. The generous size means it can also hold Big Pit reels. Equipped with a inside mesh pocket under the lid for accessories and a handle in anti-slip EVA.



		DIMENSIONS
193-30-085	Spool & Reel Case	22x30x11 cm

REEL CASE



Case to carry reel in total safety. Padded in EVA to protect against knocks and equipped with a carry handle.

		DIMENSIONS
193-30-080	Reel Case	21x16x11 cm

REEL PROTECTOR

Protects reels when they are mounted on the rod. Handy and quick, it satisfies the demands of those who appreciate practicality.

193-30-083	Reel Protector
------------	----------------



ATTRACTION BIVVY STATIONS



PRO STATION

We designed these new stations to store all the tackles in one single and practical bag, making simpler to find what you need. It is always time consuming and enervating to open half a dozen of small bags to find out what you need. So we decided to concentrate everything in one single station that is anyway offered in two sizes: the larger one is dedicated for people fishing in long sessions and using a lot of tackles, the smaller one is for the more organized carp anglers that can discern easily what they will need and what won't. Inside the station you can find three pots and several tackle boxes. The smaller version features six HDE (High Density

STATION

Eva) discs where to put the ready rigs, while the larger one features a cylindrical HDE tube (the same you can find in the Cayenne Rig Bin). The stations have four telescopic legs that can be adjusted in their position and secured with Velcro straps. The bottom part is rubber covered and can be washed easily.

		DIMENSIONS
193-30-460	Attraction Pro Station	50x35x13 cm
193-30-450	Attraction Station	43x30x13cm

GLADIO TECK BAG



The Gladio Tech bag offers a great transport capacity. Its specific property to open in two equal parts like a book is ingenious, cause in this way it will create a stiff and stable support surface where you can prepare your rigs with easy. Inside the bag you find two great spaces: in the first one there are six pots and a large tackle box, the second one is completely empty to allow you to store bulky stuff or several tackle boxes. The bag is made of sturdy fabric that can be washed easily.

		DIMENSIONS
193-30-440	Gladio Teck Bag	42x27x26 cm

K-BOX COMPLETE STATION

A very much advanced container for all those bits and pieces which any carp angler brings to the bank during long sessions to prepare the rigs. The telescopic, fully foldable legs convert it into a firm table, which has a wide working top with raised perimeter to avoid small things rolling off. The front drawer carries an EVA board to store ready rigs, while an internal box and tray can be hung on each side. Inside, many spaces can be adapted to personal needs, while three small boxes with 4, 6 and 8 compartments provide plenty of room for small accessories such as swivels, hooks, beads, clips, etc. The whole thing is quite compact when legs are fold down, and it's coloured in dark, classic green.



		DIMENSIONS
190-75-000	K-Box Complete Station	49x33x14 cm*

*Closed Sizes





K-BOX UNITS PRO

The new K-Box Unit Pro is able to store an incredible quantity of small accessories. In this unit is possible to fit two Rig Storage SL, eight Accessory Box, and many other rigs materials. Like the other Unit (medium and large) this box have meters and inches scale printed on the top.

190-74-125 Unit Pro

* Accessory Boxes not included

364x286x61 mm

K-BOXES UNITS

Unit large and medium are the best to contain all carp fishing accessories. The divisors are removable to personalize each box. You can fill them with hooks, rockets, leads, and so on, but also small tools thanks to the accessory boxes. K Boxes are equipped of strong tops, shock resistant, on which you can find a meters and inches meter, very useful for rigs. The spring lock zips are reinforced.



190-74-120 Unit Medium

190-74-110 Unit Large

UNIT MEDIUM
236x221x61 mm

UNIT LARGE
346x236x61 mm

K-BOXES COMPLETE SET



190-74-200 Complete Set (Unit+Rig Box+6 Acc.Boxes)





K-BOX RIGS STORAGE SL

This new rig box is made following the same quality standard of our well known K-Karp boxes. This rig storage feature a thinner shape which allow to store two rigs boxes on the same space where before was possible to store just one rig box. Fitting the rig still easy and fast thanks to the special bar for the hooks and the pins. Two small compartment inside allow to store other small accessories.

190-74-102 K-Box Rigs Storage SL

340x84x25 mm

K-BOX RIGS STORAGE

K-Karp have designed these special rigid boxes for rig protection. Inserting the rigs is easy and fast, attaching the hooks to the special bar and fixi the line with the special pins. This box can carry over 50 rigs to be instantly ready for use in every situation. There is further space inside to store other small accessories to tie new rigs.

190-74-100 K-Box Rigs Storage



340x93x47 mm

ACCESSORY BOX

These boxes allow you to put in all your small tools, in a orderly way far from water and dust. They are perfect for swivels, clips, sleeves and others small accessories. All the Units perfectly fit with all the accessory Boxes.

190-74-142 Accessory Box 2 Compt.

190-74-143 Accessory Box 3 Compt.

190-74-144 Accessory Box 4 Compt.

190-74-146 Accessory Box 6 Compt.

190-74-148 Accessory Box 8 Compt.

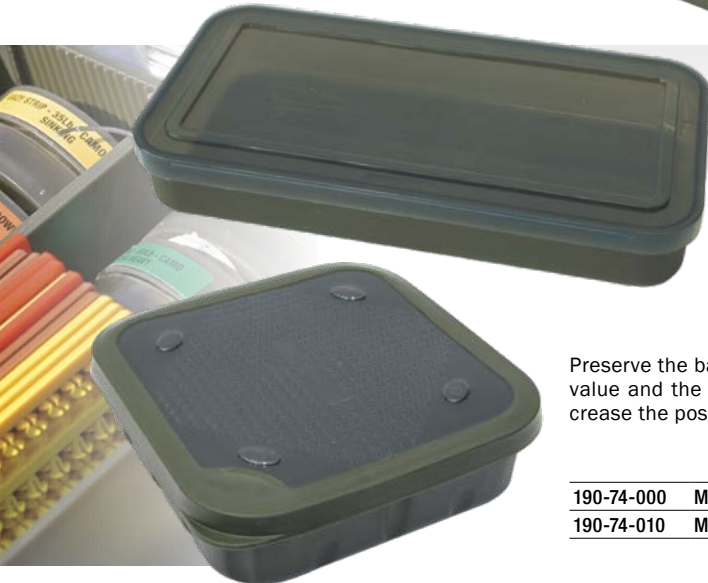

MAGIC BOXES

Special plastics boxes that don't absorb the flavours, ideal for the storage and transport of your favourite baits.

Preserve the baits, maintaining the nutritional value and the integrity of the flavours will increase the possibilities of success.

190-74-000 Magic Box Double 5.5pt

190-74-010 Magic Box 2.2pt

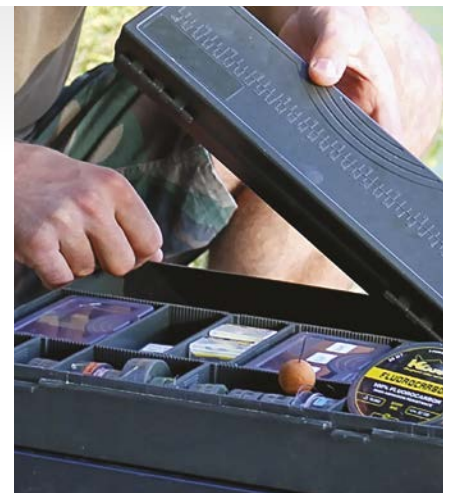

CARP CARE

BUILT TO PROTECT



CAYENNE EVO MAT

The new Cayenne mat measures 130x80cm and when opened is large enough to safely protect your bigger and vivacious carp. The raised outer edges help the fish to stay in the center of the mat. It is filled with a thick and highly protective foam padding. Construction is really lightweight and waterproof material prevents absorption of water. Special PU coating is extremely comfortable for the carp and it is easy to wash. Thanks to the many zips every part of the padding is removable.



		DIMENSIONS
193-40-140	Cayenne Evo Mat	131x80x10.5 cm

CRUSADER CARP CRADLE

The total value of technical and quality specification pushes this cradle on top of K-Karp specific range. First of all the dimensions are impressive: with more than one metre length and sixty centimetres width, it can contain any carp that swims in Europe or most grass carp. Fully made from PVC, the container offers the adjustable depth and features two side mesh to download the excess of water. The folding cover can be used to protect the fish from direct sunrays and to keep it calm, thanks to the darkness which can be created underneath. All legs feature tilting mud feet and have the adjustable length. For ease of transport, this cradle has been designed to be fold down in two halves.



		DIMENSIONS
193-40-170	Crusader Carp Cradle	101x62x36 cm



NURSYP CARP CRADLE

The K-Karp team always directed attention to the carp care. The carp care is always important for everybody but even more for people that wants to take pictures of their carps. This is the reason why the guys from the K-Karp team designed the Nursy, a crib that grants a sure protection to every carp, even the more nervous. The aluminium frame is light weight but sturdy and the adjustable anti mud feet make it stable on every terrain. The upper part is equipped with a double water-repellent sheet to protect the carp from direct sunlight and keeping it more calm. The measurements of the crib have been se to host both big carp and amur.



		DIMENSIONS
193-40-160	Nursy Carp Cradle	145x80x40 cm



XTR DIGITAL SCALE

Among many accessories currently used by the serious carp angler, scales and camera are as important as most of the others, as everybody likes to bring home nice images to remember the personal best forever. This XTR model by K-Karp provides the best possible service on the basis of an impressive list of quality points.

- Waterproof body
- Folding arms, useful to lift heavy fish
- Maximum weight 50 kg (110 lbs)
- 20 grams intervals
- Displays weight in kg - lbs - oz
- Powered by 2 AAA batteries (not included)
- Automatic lock of weight indication
- Temperature indication in °C or °F
- Blue display light
- Automatic switch off
- Magmetic hook hold (on back side)



190-50-390	XTR Digital Scale
------------	-------------------

TOTAL AIR SACK

Big sized carp sack with waterproof PVC bag. For this product we used the best materials available, slime friendly and extremely soft. Oversized zip closure with clip, ventilated corners. The K-Karp team is allways working to keep maximum attention to carp safety and care, that's why we pay much attention to details and we recommend to keep not more than one carp on the same carp sack. We used a bright red foam floats on the rope, to immediately detect where the carp sack is located.



		DIMENSIONS
193-40-130	Total Air Sack	120x100 cm

SUPER MAT

Exceptional mat for unhooking, weighing and returning the fish to the water. This mat has been developed to comfortably hold the fish during the unhooking, weighing and return into the water. The mat is fitted with a velcro closure system that avoids the carp falling dangerously in the case of sudden movements. The closure mesh also enables the angler to always have the fish under control when inside. The sides are generously padded to offer the maximum protection. The inside is PVC dressed - this avoids dangerous damage to the carps mucus, and can be easily washed. Super Mat is able to keep and to protect the biggest carps, a record even!

		DIMENSIONS
193-40-020	Super Mat	104x50 cm



CRUSADER LANDING NET

NEW 2019

Crusader landing net has a stiff and slim Powerfibre handle, complete of non-slip grips. The precise screw thread has been machined out of a block of solid alloy and then firmly secured to the handle. Powerfibre net's arms are 42" long equal to 104cm. The net itself is made of hexagonal soft yarn mesh, to prevent any injury to the carp. The mesh is a new camouflage colour.

		DIMENSIONS
084-41-010	Crusader Landing Net * 180 cm	104x104 cm



EASY PRO MAT

This compact size unhooking mat is designed specifically for anglers who love short sessions and insist on safeguarding the care of every fish caught. The padding is not excessive and provides convenient transportation without unnecessary bulk. K-Karp recommends Easy Pro Mat in any situation also for barbel fishing.

		DIMENSIONS
193-40-060	Easy Pro Mat	100x60 cm

OVATION SACK

Perforated weighing bag designed for anglers who demand precision, even for small and medium-sized catches. The construction of the fabric allows rapid draining of excess water, thereby ensuring accurate weight readings.



		DIMENSIONS
193-40-070	Ovation Sack	85x55 cm



GLADIO LANDING NET & WEIGHSLING

The landing net-weighing sling Gladio is characterized by a number of innovative features to help your fishing and offer the ultimate in care of the fish. One piece Carbon handle 180cm long, ultra-resistant carbon arms, with a hexagonal mesh built with a specific yarn that is not entangled and does not harm the fish, steel block with quick release system. But the real peculiarity is that the mesh, when detached, it becomes a real weighing sling with handles and sides with double-stitched immune to the deterioration and zipper closure on top.

084-40-700 Gladio L/Net & Weighsling *1.80 cm



INTREPID NET HANDLE

Net handle with 1K Woven Carbon printing, extremely lightweight and totally reliable can easily handle the bigger carp to the unhooking mat.

The special carbon used allows to drastically reduce the diameter and to keep good stiffness. Anti slip wrapping and solid metallic screw.



084-40-650 Intrepid Net Handle * 180 cm

CRUSADER NET HEAD STINK BAG

It has been specially designed to contain the carp net head, saving the car's cabin from water's drip and from the horrible stink usually sent out by the wet net after being used. Completely made from PVC, it's totally waterproof and easily washable. The generous sizes and the reglable strap allow to accept any size of landing net. The outside, lateral pocket, featuring its own strap, enable to transport the handle as well.

193-40-190 Crusader Net Head Stink Bag



XTR SPARE CARP NET

This spare net is 42" and will fit every landing net. It is made of two different textures designed to carefully protect the carp, not harming its skin, scales and fins, and to be strong and resistant along the perimeter. We always care carps' health and pursue long lasting tackles.

084-40-850 XTR Spare Carp Net



LANDING NET FLOAT

The Landing Net Float is designed to make easier netting the carp while playing the fish. The net float allows the entire landing net to float just on the surface and ready to action. The Net Float will prevent also the mesh snagging on the lake bed, that's the last thing you want to happen when playing a record carp.

193-30-190 Landing Net Float



ROD PODS

BUILT TOGETHER CONCEPT

The K-Karp range of rod pods is quite wide and appreciated as it can meet all different carpfishing needs. Like all products designed and marketed by K-Karp, also in this case our staff and testers carried out the development and testing of every single product to assess their stability, duration and easy adjustment.



The strict tests our pods undergo before being put on the market mean we can supply you with products of the highest quality standards. We have also opted for a variety of shapes to satisfy individual needs and to ensure easy use and exceptional stability on all kinds of ground. Every pod is highly adjustable, especially in height, to overcome the various obstacles that can be met in European waters. We have tried to eliminate unnecessary



adjusting screws, repositioning those remaining in a smart way, to make them more practical to use and as far as possible prevent the chance of line tangling during fishing action. All pods are supplied with carry-bags designed individually to perfectly hold all the parts. The materials used for the bags (up to 1200 denier) are extremely hard-wearing and the extra-strong zips are matched by strong comfortable grip handles.



NEW 2019

FUSION
BLACK POD - 4 ROD

- A great allrounder designed to deliver stability when fishing on large lakes or rivers.
- Highly customizable structure, allowing the angler to choose several solutions to fit most fishing styles and conditions.
- Legs can be adjusted independently both in its inclination and angle.
- The body can be adjusted in length to fit the bank and all standard rod length.
- The rear buzzer bar block can be moved along the body
- Provided with a pair of additional legs and carry bag.

192-00-360 Fusion Black Pod



Here above are displayed just some of the configurations the Fusion Pod can be set-up on the bank.

ROD PODS

CAYENNE BLACK POD | GLADIO X-LITE

CAYENNE BLACK POD

NEW 2019

Cayenne Black Edition is an evolution of the original Cayenne pod, definitely one of the most versatile and simple KK pods to use. Improvements have been made on the original structure and the central hub, to increase strength, stability and to further improve the clamping and locking possibilities. These features make it one of the best pods on the market. Additionally the buzzer bars has been improved and are now stronger, more ergonomic and appealing. The legs suit perfectly any terrain and they're still fitted with the practical and robust Fast Lock System. The central hook, allows for a weight to be added for increase stability. The Cayenne Pod is equipped with a very durable cordura carry bag

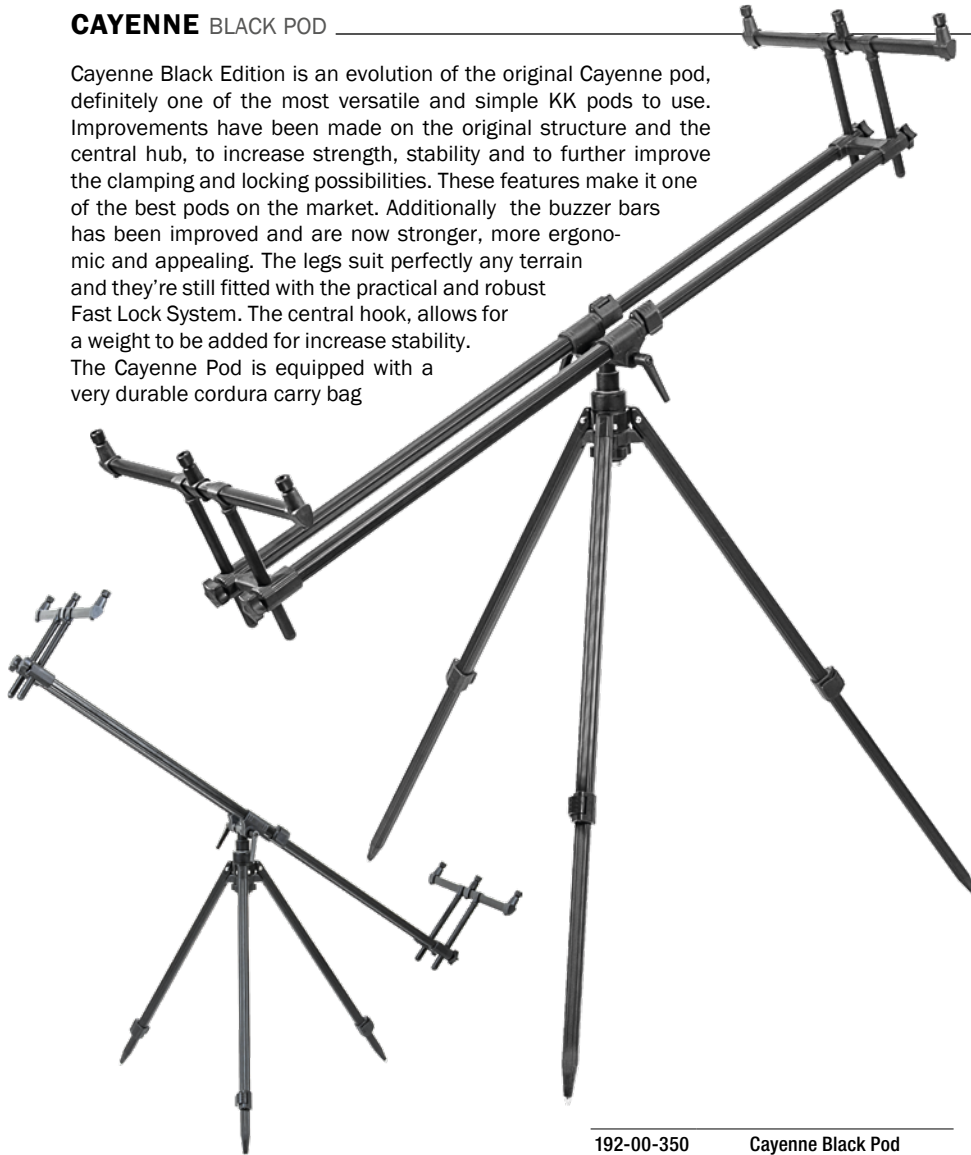

192-00-350 Cayenne Black Pod

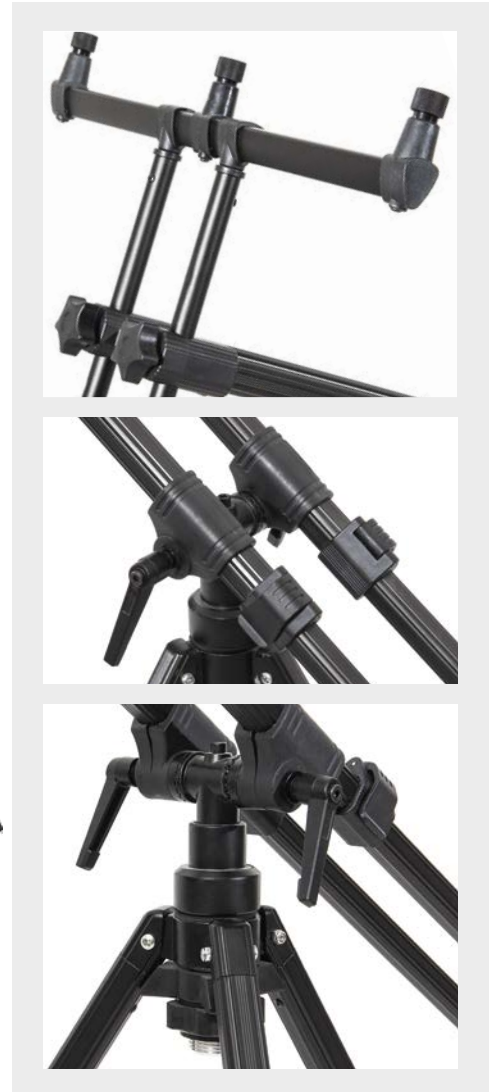

GLADIO X-LITE POD

NEW 2019

Goalpost styled rod pod, extremely compact and lightweight. It uses a built around a central core that houses all four legs held in place by a block closure. Stable, manageable, robust and reliable, is likely to be transferred from one location to another mounted, without tipping over as with other types of pods and can be disassembled in few seconds. Fully adjustable, is presented with 3 rods buzzer bars and four adjustable legs, which allow you to level the pod in the right position even in the most uncomfortable swims.



192-00-330

Gladio X-Lite Pod

ANTIDOTE ROD POD

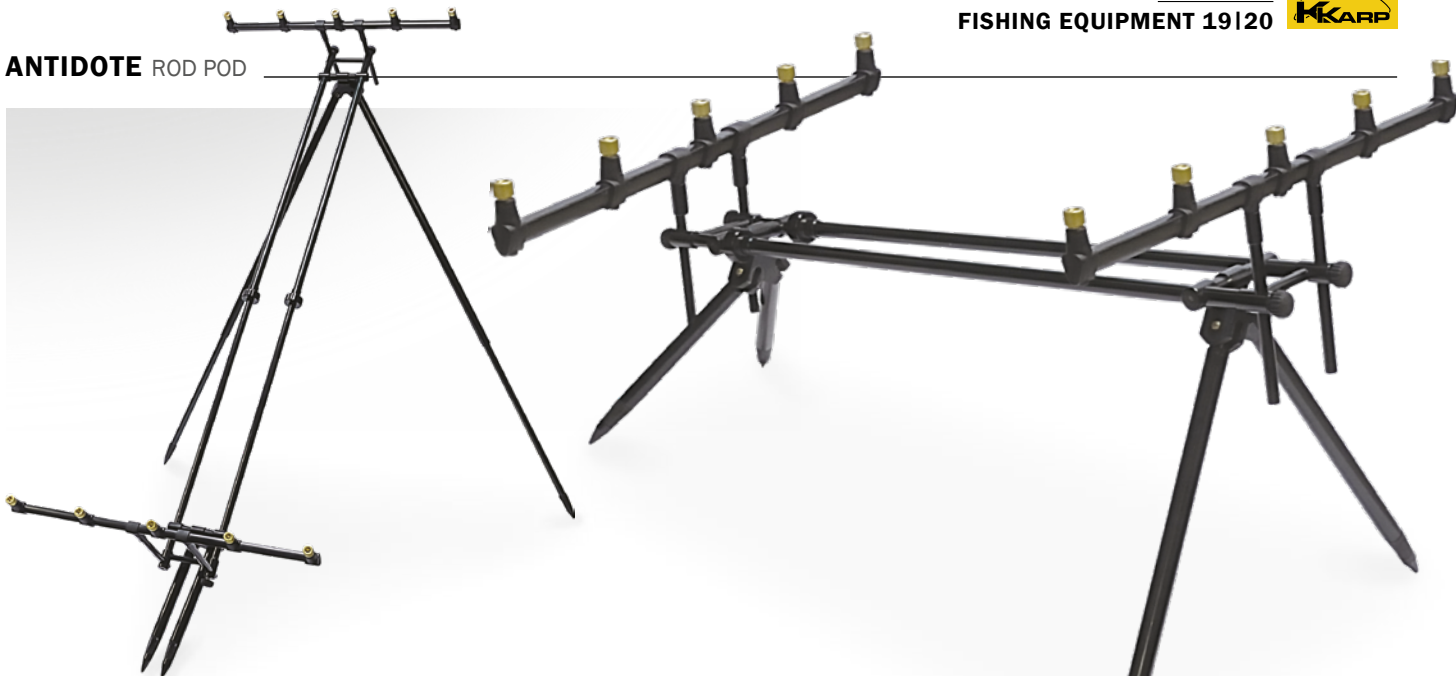

The experience of the K-Karp Team has designed a pod to meet a range of needs almost infinite, in fact, the Antidote Pod can be at home in a variety of situations for the facility with which you can replace the normal legs with a pair of longer ones (Sky Option), being able to direct the rods both towards the sky or towards the water surface, but always keeping a flawless stability thanks to the wide base of support. The combinations to adjust this pod are virtually endless adapting to the needs of each angler in every situation, every component is fully adjustable. The Buzzer Bar has five places, so they can be used with either three or four rods keeping them always equidistant.



192-00-250 Antidote Rod Pod

REACTION ROD POD



The range of use of this pod is really wide, it can actually be used both in a big lake or in a small canal, due to the adjustable legs, that can be extended up to an incredible length. It is the perfect solution too for the anglers that need to position the rods very high, pointing to the sky, to by pass obstacles close to the shore. But it can be the perfect solution also for the angler fishing in a more neat venue, where the rods can stay horizontal. The legs junction has been engineered with great attention, getting a new design that is perfect to perfectly fit to every terrain, making this pod absolutely brilliant and versatile. The possibility to change the configuration of the pod allows you to pass from a 4 legs pod to a 3 one, thus really covering every need. Every angler should have a pod like this! Made of strong and light weight aluminium.

192-00-300 Reaction MKII Rod Pod





DRAKE TX POD

Brand new pod designed from the original Drake design, an ultra-lightweight and compact goal post style pod with a low centre of gravity makes this a very stable set-up on any bank. Supplied with a 3 rods buzzer bars and featuring a central telescopic frame to fit on any standard rod length. Easy to pack releasing legs and buzz bars. The special aluminium tubes are light and stable granting a perfect alignment between rod rests and bite detectors.

NEW 2019

192-00-340

Drake TX Pod

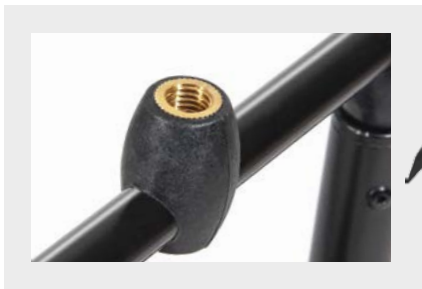

SNIPER POD



Probably the most versatile of all the Pods produced by the K-Karp Team. Packs very small for transport, but once open its size and stability are surprising. Constructed in stainless steel, it adapts to any kind of placement, even the most improbable, thanks to the adjustable central bar that turns on a floating pivot and can be locked at practically any angle, either frontally or laterally. Inclination of the telescopic feet is self-locking by means of aluminium hooks fixed to a central steel pivot. Speed of assembly and positioning are the main features of this exceptional pod, ideal for short or medium range use. The Sniper pod comes with a practical carry-bag. The price does not include buzzer bars.



*Buzzer Bars not included

192-00-000

Sniper Pod



REACTION BARROW

Innovative trolley which allows you to keep up the load in any situation of rough terrain or slope. Reaction Barrow is robust, quick to assemble and adjustable in both length and width so it can be adapted to transport every kind of equipment. Supplied with tubeless wheels, locking

points for elastic ropes and low profile chassis. Cordura covered side banks for better load protection. In a nutshell the best all grounds trolley you can buy.

192-30-180

Reaction Barrow



EXCELLENCE POD

This is one of most versatile, functional, most highly adjustable pods. Impressive also for its size and stability, given by the use of a tripod mounted on telescopic legs which can be adjusted individually to suit the ground or increase the area of rest surface in case of strong winds. In addition, there are holes at the end of the legs to insert an anchoring stake. Aluminium is the main material used for this pod, making it easy to position and reducing the weight,

which can be a problem with many pods, all without compromising its strength and reliability. The central base is equipped with a new system with a central pivot which can be turned to any angle, either frontally or laterally, within a 360° radius. The central arm can also be made longer to correctly position the rods. Buzzer bars are not included in the price.

192-00-100

Excellence Pod



*Buzzer Bars not included

XTR POWER BAR



System equipped with buzz bars and pegs included. It is very suitable for fishing in all those places where you can plant your pegs, considerably reducing the overall weight of your tackles and speeding up the preparation of our base camp. Its minimalist but solid nature ensures that you can plant them even in hard ground and achieve a good result.

192-20-120 XTR Power Bar



BUZZER BARS

Buzzer Bar models are in stainless steel or in aluminium. Most of them are telescopic so they can be extended. A little plaque in each Buzzer Bar shows that they have been tested with the maximum care.

192-20-010 Stainless Steel Inox 3 canne Tel.

REGOLAZIONE LATERALE



PIONEER PRO BUZZ BAG

We all know how important is to store our buzz bars with the alarms mounted on. That is why we designed a bag that could protect the alarms in best way possible. A thin and padded divider separates the front buzz bar from the back one, while useful inner pockets can host small tools, tackles and tool kits.

193-30-115	Pioneer Pro Buzz Bag	DIMENSIONS 72x20x10 cm
------------	----------------------	----------------------------------



BANKSTICK SCREW END

Bank stick with steel drill point to penetrate the toughest grounds - they can be used to build a simple rod pod in every situation (i.e. when rods are very close to water). They are fitted with a steel bar to help screw into the hard ground.

192-07-000	Screw End Bankstick L
192-07-100	Screw End Bankstick XL



BANKSTICK PROTECTOR



Planting your bankstick, even in hard ground, will no longer be your problem! Often we give up cause of our hands sore but now we just to screw the Bankstick Protector to have a solid fulcrum in our hand. It is also possible to hammer down the bankstick while preserving its integrity.

190-50-230/10 BankStick Protector

BANKSTICK BAG

No carp angler can live without banksticks, but they need some careful attention during transport, because they can be dangerous for the rest of the tackle and accessories. So K-Karp developed this clever solution, easy to use and quickly washable, made from tear free and waterproof material. The banksticks are fixed by an elastic band and a second Velcro strap; all points fit into several dedicated pockets. The bag folds down to keep a limited space in the car's booth or in the bivvy bag.

193-00-105	Bankstick Bag	DIMENSIONS 60x45 cm
------------	---------------	-------------------------------





XTR BUTT REST LUMINOUS

Thanks to the XTR Luminous Back Rests it will not be difficult to identify the rod pod even in the darkest of nights without using any light source. It is sufficient the daylight to charge them, then they will be bright in darkness. They deliver an exceptional grip avoiding butt rods to slide forward while the stainless steel screw ensures a lifetime performance. The XTR Luminous Back Rests are sold in blister packs of three pieces each.



192-25-260/5 XTR Luminous Butt Rest / 3pcs

ANTI DRAW BACK REST

Anti Draw Back rest is designed to grip the rod tightly eliminating the danger of slippage during the run of the carp. The innovative spring lock system works in just one direction and releases the rod only when the angler picks it up. Suitable for almost every rod from 10 mm up to 35 mm, it's fitted with a stainless steel thread with adjusting nut.



192-25-250/10 Anti Draw Back Rest

XTR SNAG EARS

Stainless steel is the total constituent of this kit, born to increase the security of your rods. It should be mounted behind your bite alarms and ensures greater stability of your fishing rods in case of strong wind or violent runs of carps, that may shift them from their posts. They are adjustable in height and their particular profile prevents line tangles.

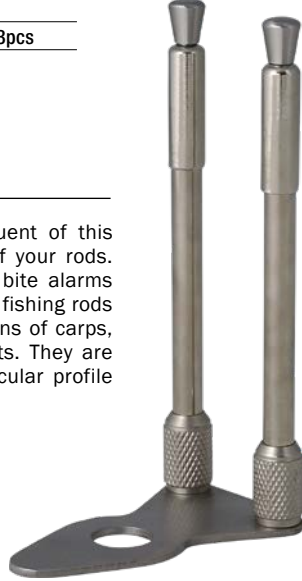

192-25-300/5 XTR Snag Ears



SS SPACER

Premium grade stainless-steel spacer for attaching your favorite K-Karp alarms to buzz bars. The increased clearance above the buzz bars helps to fit neatly any visual bite indicators and access the alarms functions with ease. Fits all K-Karp metal ware products and alarms.

190-50-240/10 SS Spacer

XTR ADJUSTABLE BUTT REST

The K-Karp Team endorsed the production of this precision engineered stainless steel rear rod rest with adjustable width via thumb screws on its side, and able to lock full eva/cork to abbreviated butts with ease. The rubber sleeves offer a tight grip in every conditions and the locking collar helps to align perfectly the rods on the buzzer bar.

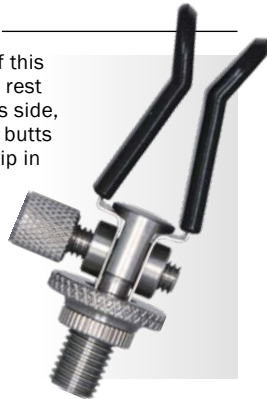

192-25-290/6 XTR Adjustable Butt Rest

ROD REST SET

A very simple, old fashioned, rod rest that delivers its job properly. With a few coins it is possible to buy a complete 3 rods set. Good performance and long lasting.



192-25-270/10 Rod Rest Set / 3pcs

ROD CLIPS

K-Karp clips are in a non slip "Soft Touch" rubber that allows them to fix to the rods safely and to easily release on the strike. All threads are made by stainless steel or brass, for the maximum resistance against elements and therefore to guarantee a long-life usage. Moreover all K-Karp Butt Rests are fitted with a locking nut to allow the correct positioning every time.

SURE LOCK BUTT REST

Butt Rest based on new concept, lightweight, elastic enough and very efficient. Its main characteristic consists in the automatic locking mechanism, which clamps the rod's butt preventing it from falling or being blown away by the wind. A slight pressure activates the pivoting arms, while the extraction of the rod in the event of bite is equally easy.



192-25-120/5 Sure Lock Butt Rest



192-25-100/5 Master Butt Grip

192-25-110/5 Super Butt Grip S/S

192-25-210/10 Slim Butt Grip

192-25-200/10 SS Rod Rest

192-25-130/5 Fast Lock Rubber B.G. Small

192-25-140/5 Fast Lock Rubber B.G. Medium

LINES & LEADERS

XTREME



FLUORO COATED & CAMOU MAINLINES

All The Xtreme lines are sold with tin container to guarantee the extra protection, keeping it in a permanent darkness and out of direct sunlight, as well as to maintain it at a constant level of humidity. Always remember to return the unused line to the tin and store it away from heat and direct sunlight. To keep the line in pinpoint conditions, please always remember to wipe it with a damp cloth at the end of every session, this will remove any debris and increase its lifetime. Please take extra care when loading your Xtreme line onto your reel's spool:

always allow the spool to spin freely when loading into the reel, applying a good level of resistance by gently trapping the line between your fingers or loading the line from a warm bucket of water thus resetting any memory coils, giving you a perfectly filled reel's spool.

Suggested Knots: Double Grinner / Albright Special / Grinner / Half Blood / Palomar



A small label, applied every 200 metres of line, enables to spool the reel with maximum accuracy. This solution avoids line waste, helps to partially use the product and gives you the indication about how much line you've left.



XTREME FLUOROCARBON COATED LINE | CAMOUFLAGED LINE

FLUOROCARBON COATED LINE

The Xtreme Fluorocarbon is the ultimate choice for the allround carpers, offering an ultra low visibility and the ultimate camouflage. By using the latest line extrusion technology, XTREME exhibits outstanding suppleness with the stiff wiry feel often found on super tough reel lines. The fluorocarbon coating adds weight to the line for a superb sinking action, high knot strength and increased abrasion resistance for fishing in heavy weed or snaggy swims, all combined with a low stretch and memory free, whilst the super smooth surface aids casting distance and accuracy.



- High Abrasion Resistance
- Low Stretch Monofilament
- Superior Knot Strength
- Molecular Treatment

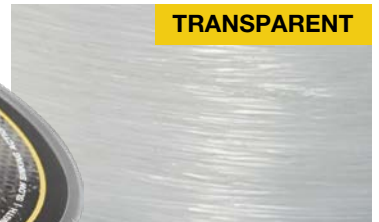

	COLOR	YDS/M	ØMM	⚖	🐟
198-33-280/3	Transparent	1100/1000	0.286	9.80	22
198-33-300/3	Transparent	1100/1000	0.309	11.95	26
198-33-350/3	Transparent	1100/1000	0.354	15.80	35
198-33-400/3	Transparent	1100/1000	0.405	21.15	47

ADVANCED CAMOUFLAGED LINE

The Xtreme Camo line, as the name itself suggests, has been specially designed to withstand extreme fishing conditions as gravel bars and snaggy swims. Produced by technologically innovative copolymers, Xtreme features a tremendous abrasion resistance, high knot strength, a low stretch and total absence of memory, thus combined to a great suppleness and a slow sinking rate. The Camo Green Colour is designed to fish in heavy weed, while the Camo Brown is perfect on high abrasive gravel bars and snaggy swims.

	COLOR	YDS/M	ØMM	⚖	🐟
198-31-280/3	Camo Green	1100/1000	0.286	9.80	22
198-31-300/3	Camo Green	1100/1000	0.309	11.95	26
198-31-350/3	Camo Green	1100/1000	0.354	15.80	35
198-31-400/3	Camo Green	1100/1000	0.405	21.15	47
198-32-280/3	Camo Brown	1100/1000	0.286	9.80	22
198-32-300/3	Camo Brown	1100/1000	0.309	11.95	26
198-32-350/3	Camo Brown	1100/1000	0.354	15.80	35
198-32-400/3	Camo Brown	1100/1000	0.405	21.15	47

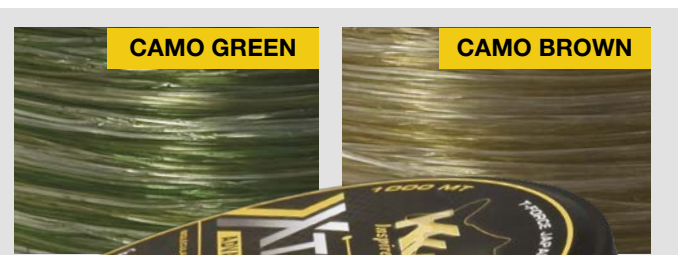

DYNA-TEX POWER BRAID



An excellent braided line wholly yarned by Dyna-Tex, the special fibre invented and developed by our Karp K-Team. Dyna Tex features an extraordinary compactness, associated with a very small diameter compared to the tensile strength and it presents “zero” elongation. This combination makes it ideal for fishing at long range and even extreme range. Moreover, the strong resistance to abrasion and knot strength provide a virtually unlimited use over time and in any fishing situation. Especially good when used in swims containing snags, weed and gravel where wear resistance is essential. The green colour gives camouflage on most lake bottoms.

	YDS/M	ØMM	⚖	🐟
198-50-030/5	500/457	0.24	13.61	30
198-50-040/5	500/457	0.28	18.14	40
198-50-045/5	500/457	0.30	20.41	45
198-50-050/5	500/457	0.34	22.68	50
198-50-060/5	500/457	0.37	27.22	60
198-51-030/1	1500/1371	0.24	13.61	30
198-51-040/1	1500/1371	0.28	18.14	40
198-51-045/1	1500/1371	0.30	20.41	45
198-51-050/1	1500/1371	0.34	22.68	50
198-51-060/1	1500/1371	0.37	27.22	60

HI-FLOW

	YDS/M	ØMM	⚖	🐟
198-20-250/10	330/300	0.255	5.80	13
198-20-280/10	330/300	0.286	7.15	16
198-20-300/10	330/300	0.309	8.50	19
198-20-320/10	330/300	0.325	9.45	21
198-20-350/10	330/300	0.354	10.50	23
198-20-400/10	330/300	0.405	13.50	30
198-21-250/10	660/600	0.255	5.80	13
198-21-280/10	660/600	0.286	7.15	16
198-21-300/10	660/600	0.309	8.50	19
198-21-320/10	660/600	0.325	9.45	21
198-21-350/10	660/600	0.354	10.50	23
198-21-400/10	660/600	0.405	13.50	30
198-22-250/1	1300/1200	0.255	5.80	13
198-22-280/1	1300/1200	0.286	7.15	16
198-22-300/1	1300/1200	0.309	8.50	19
198-22-320/1	1300/1200	0.325	9.45	21
198-22-350/1	1300/1200	0.354	10.50	23
198-22-400/1	1300/1200	0.405	13.50	30

Monofilament that is manufactured and spooled observing all the strict rules of K-Karp standards. However it has a very competitive price. This line is particularly strong, abrasion resistant and it has a good knot strength. We suggest to use Palomar, double Palomar or Grinner knots. Its dark colour is perfect for all lake beds.



MONO PLUS

Carp-Fishing specific line with excellent knot strength, very good abrasion resistance, complete absence of memory and super soft. It is exceptional for its extra low stretch characteristic. The best line for wary fish in difficult swims with sunken and hidden obstacles. Its light brown colour, nearly neutral, makes a perfect camouflage on every type of bottom.

	YDS/M	ØMM	⚖	🐟
198-05-280/6	660/600	0.286	10.43	23
198-05-330/6	660/600	0.331	14.97	33
198-05-370/6	660/600	0.370	16.78	37
198-06-280/6	660/600	0.286	10.43	23
198-06-330/6	660/600	0.331	14.97	33
198-06-370/6	660/600	0.370	16.78	37
198-07-280/1	1300/1200	0.286	10.43	23
198-07-330/1	1300/1200	0.331	14.97	33
198-07-370/1	1300/1200	0.370	16.78	37





SINKING PLUS

	YDS/M	ØMM	⚖	🐟
198-15-250/6	330/300	0.255	8.36	18
198-15-280/6	330/300	0.286	9.80	22
198-15-300/6	330/300	0.309	11.95	26
198-15-320/6	330/300	0.325	13.85	31
198-15-350/6	330/300	0.354	15.80	35
198-15-400/6	330/300	0.405	21.15	47

	YDS/M	ØMM	⚖	🐟
198-16-250/6	660/600	0.255	8.36	18
198-16-280/6	660/600	0.286	9.80	22
198-16-300/6	660/600	0.309	11.95	26
198-16-320/6	660/600	0.325	13.85	31
198-16-350/6	660/600	0.354	15.80	35
198-16-400/6	660/600	0.405	21.15	47

	YDS/M	ØMM	⚖	🐟
198-17-250/1	1300/1200	0.255	8.36	18
198-17-280/1	1300/1200	0.286	9.80	22
198-17-300/1	1300/1200	0.309	11.95	26
198-17-320/1	1300/1200	0.325	13.85	31
198-17-350/1	1300/1200	0.354	15.80	35
198-17-400/1	1300/1200	0.405	21.15	47



Sinking Plus line uses advanced dyeing technology to create a camouflage effect through five different tonal colours that alternate every 30 cm. Unquestionably, this breaks up the shape and appearance of the line, helping it to blend in and disappear whatever the surroundings. It is without any doubt, one of the most technological lines on the market nowadays, enabling maintenance of sinking quality and an incredible abrasion resistance. Despite all these qualities, it keeps its softness along with low stretch and it doesn't suffer the torsion effect. Ideal in clear waters when camouflage is necessary.

SHOCK LEADER IMPACT

This Monofilament has been introduced exclusively for the creation of Shock Leaders. Effectively having "Zero Memory" thanks to its unique rigid structure, it has been tested to resist the most aggressive and powerful casting. Moreover, the special treatment Super Cast allows extreme casting distances, speeding the flow of the line through the guides and by its increased natural resistance to abrasion. It is also ideal when using a shock leader as anti abrasion piece, enabling fishing in areas where there are many sharp and rough obstacles. The brown colour ensures a unique camouflage on any bottom.

	YDS/M	ØMM	⚖	🐟
198-35-500/10	110/100	0.500	34.96	77
198-35-600/10	110/100	0.600	38.20	84
198-35-700/10	110/100	0.700	41.70	92

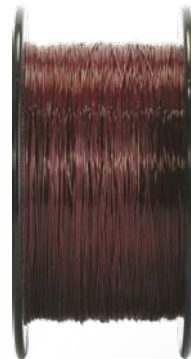

MIMETIC MONO

At the request of a wide array of carp anglers, K-Karp has designed the Mimetic monofilament, which is dedicated to those who love fishing in rivers or in waters where many obstacles are present. Its camou color ensures a perfect camouflage on the bottom and, in clear water conditions it helps to break the visibility of the line thanks to alternation of shades of green and brown. Resistance to abrasion, good knot strength and the low elasticity of Mimetic make a really tough line suitable for the most challenging waters. The price is highly competitive and it is available up to 0,50 mm diameter.

	YDS/M	ØMM	⚖	🐟
198-24-300/10	330/300	0.309	8.50	19
198-24-320/10	330/300	0.325	9.45	21
198-24-350/10	330/300	0.354	10.50	23
198-24-400/10	330/300	0.405	13.50	30
198-24-450/10	330/300	0.450	15.00	33
198-24-500/10	330/300	0.500	18.00	40

	YDS/M	ØMM	⚖	🐟
198-25-300/6	660/600	0.309	8.50	19
198-25-320/6	660/600	0.325	9.45	21
198-25-350/6	660/600	0.354	10.50	23
198-25-400/6	660/600	0.405	13.50	30
198-25-450/6	660/600	0.450	15.00	33
198-25-500/6	660/600	0.500	18.00	40

	YDS/M	ØMM	⚖	🐟
198-26-300/1	1300/1200	0.309	8.50	19
198-26-320/1	1300/1200	0.325	9.45	21
198-26-350/1	1300/1200	0.354	10.50	23
198-26-400/1	1300/1200	0.405	13.50	30
198-26-450/1	1300/1200	0.450	15.00	33
198-26-500/1	1300/1200	0.500	18.00	40

HOOKLINKS

DYNA TEX ADVANCED

K-Karp in conjunction with Dyna-Tex Fiber, world leader in synthetic yarn industry, are proud to release a new range of unrivalled hooklinks. The high modulus polyethylene fibres used to braided these products are able to offer incredibly performance, in terms of abrasion resistance, strain, versatility all in relation to their low and inconspicuous diameters. All stated breaking strains refer to the line knotted by a simple knot; however, with a technically superior knot nowadays known in fishing, it's possible to achieve even more.



3K LINK

The toughest link perfect in the most extreme conditions, such as gravel bars or in snag infested swims. It's a triple structured 8 strands braid that blends together 3 materials to provide the highest abrasion resistance, strength, anti-tangle properties and high sinking ratio. X3 Link also performs excellently as a shock leader when spodding or casting.

	COLOR	MTRS	🐟
198-82-025/5	Camou	20	25
198-82-035/5	Camou	20	35
198-82-045/5	Camou	20	45

FIGHT CORE

The toughest armoured leadcore available! The outer armour is combined to 16 strands advanced PE fibres to improves dramatically the abrasion resistance, ideal for fishing in extreme conditions, as gravel bars, snaggy swims, heavy weed and other abrasive underwater obstacles. The outer sheath is made with tri-tones fibres, perfectly chosen to obtain an extreme camouflage effect when submerged in water.

	COLOR	MTRS	🐟
198-83-045/5	Weedy Green	5	45
198-83-145/5	Gravel Brown	5	45

HI-GRAVITY

The best environment friendly and most clever alternative to leadcore! It splices extremely well, producing strong loops for easy connection and it's braided with a 16 strands of ultra-heavy weight, abrasion resistant and soft fibres. Hi-Gravity hugs the contours of the lake bed improving bait presentation to target wary carp. The outer sheath is made with tri-tones fibres, perfectly chosen to obtain an extreme camouflage effect when submerged in water.

	COLOR	MTRS	🐟
198-83-245/5	Camou	10	45



CAMOU BROWN

CAMOU GREEN

XTREME SOFT SKIN

Highly abrasion resistant coated link, with a soft inner 8 strands braided core woven from exceptional strong fibres that offers superb knot strength and reliability with a round profile. Extremely supple and smooth, that hugs the contours of the lake bed improving bait presentation to target wary carp, can be knotted easily without damaging it. A great allrounder available in two low visibility camo colours.

	COLOR	MTRS	🐟
198-80-025/5	Camou Green	16	25
198-80-035/5	Camou Green	16	35
198-80-045/5	Camou Green	16	45
198-80-125/5	Camou Brown	16	25
198-80-135/5	Camou Brown	16	35
198-80-145/5	Camou Brown	16	45

XTREME STIFF SKIN

It's the ultimate link for big continental carp! The outer coating combined with the 8 strands braided inner core offers unrivalled abrasion resistance, good anti-tangle properties, strength and the required stiffness to improve anti-eject properties required for advanced rig set-up. It's ideal for fishing at long range or in extreme conditions and can be used to create all manner of rigs including Combi Rigs.



CAMOU BROWN

CAMOU GREEN

	COLOR	MTRS	🐟
198-81-025/5	Camou Green	16	25
198-81-035/5	Camou Green	16	35
198-81-045/5	Camou Green	16	45
198-81-125/5	Camou Brown	16	25
198-81-135/5	Camou Brown	16	35
198-81-145/5	Camou Brown	16	45

FX LINK

This new Fluorocarbon 100% has been developed by K-Karp team in conjunction with Dyna-Tex Fibre, world leader in the synthetic fibre's industry, to offer the dedicated carp angler an ideal material to build up very special rigs. Beyond his property to be invisible in water, this product is totally waterproof, and this means that it's abrasion free, UV safe and even oil and alcohol proof, so that it can't be harmed by flavours and liquid additives. Even though it's softer than most common Fluorocarbon materials, FX Link is heavier than nylon, so it sinks well, sitting on the bottom to create unobtrusive rigs. Consequently, rigs made from this product won't spook wary carp at all.

INVISIBLE



	COLOR	MTRS	🐟
198-85-015/5	Transparent	20	25
198-85-025/5	Transparent	20	35
198-85-035/5	Transparent	20	45

DYNA TEX

LEAD CORE

ELUSIVE

X-TRA TOUGH

EASY STRIP

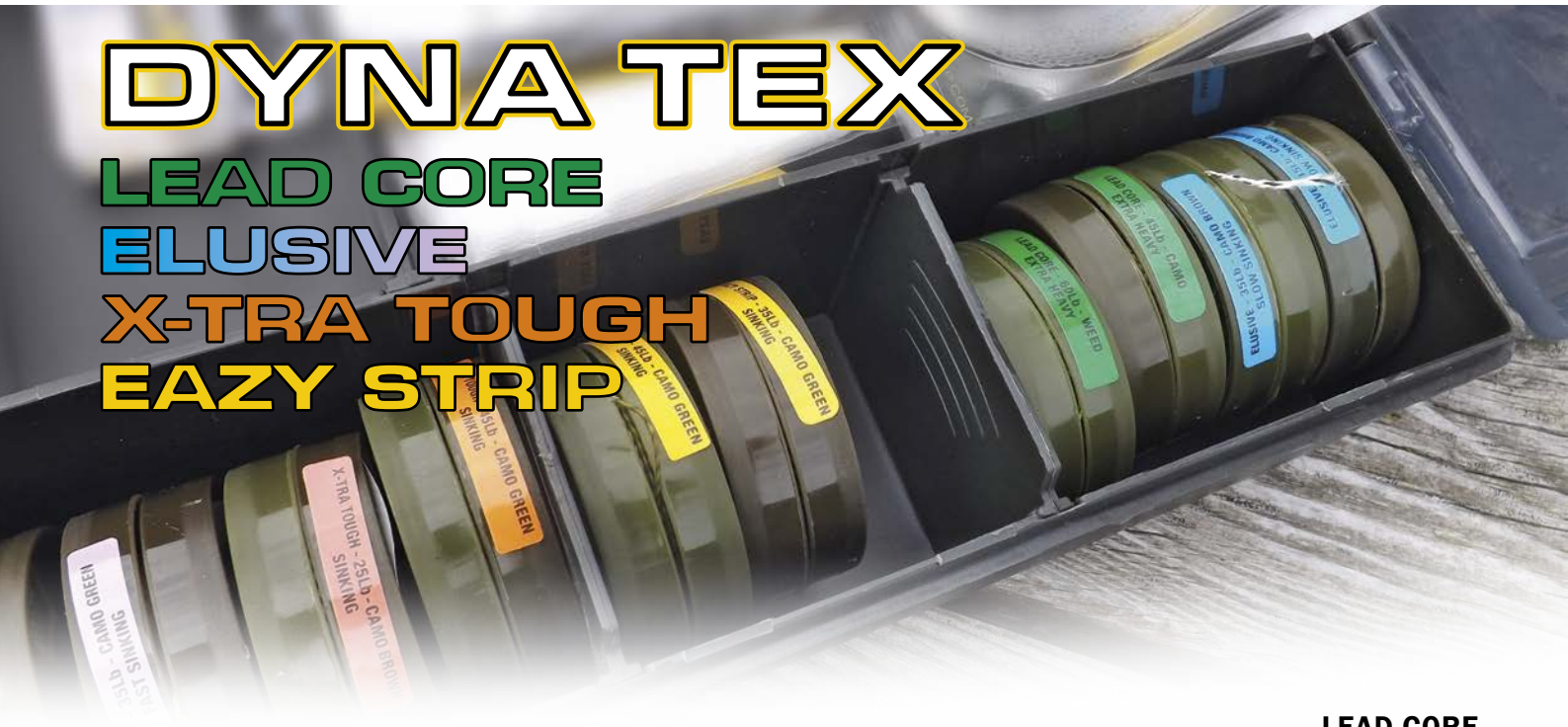

LEAD CORE

DT Lead Core is set up using Dyna Tex in two different main colours: Weed and Camo. It is notable for its extraordinary resistance to abrasion and the larger diameter of the internal lead, thanks to which the line lays perfectly on any type of bottom – remaining invisible to even most wary carp. The creation of eyes or loops for swivel or main reel line attachment is eased by a special lubricant treatment called Fast Knot, which compacts the fibres and increases durability.

	COLOR	MTRS	🐟
198-75-045/10	Weed	5	45
198-75-060/10	Weed	5	60
198-76-045/10	Camou	5	45
198-76-060/10	Camou	5	60



ELUSIVE

This is an exceptional, ultra soft braided line. It offers two sinking speeds: Fast and Slow, and two different camouflage colours. The particular design of its Dyna Tex fibres, has resulted in a softness that makes it almost completely undetectable to the carp when it eat the bait. The addition of a small percentage of Sinking Fiber with a greater specific weight, provides a quick sinking, making it perfect for hard bottoms and for very wary carp.

FAST SINKING	COLOR	MTRS	🐟
198-70-015/10	Camo Green	20	15
198-70-025/10	Camo Green	20	25
198-70-035/10	Camo Green	20	35
SLOW SINKING			
198-71-015/10	Camo Brown	20	15
198-71-025/10	Camo Brown	20	25
198-71-035/10	Camo Brown	20	35





X-TRA TOUGH

The X-Tra Tough is a braided line completely made from Dyna-Tex with an added High Resistance fibre. It has been introduced specifically for the toughest of fights in very inaccessible areas. Its exceptional resistance to abrasion, wear, and its perfect sinking action ensures tenacity and resistance in all settings. Its unique fibre's compactness allows the creation of semi-stiff rigs which enhance the hook's rotation within fish mouth. The green and brown colours provide excellent camouflage on all types of bottom.

	COLOR	MTRS	🐟
198-65-025/10	Camo Green	20	25
198-65-035/10	Camo Green	20	35
198-65-045/10	Camo Green	20	45
198-66-025/10	Camo Brown	20	25
198-66-035/10	Camo Brown	20	35
198-66-045/10	Camo Brown	20	45



EAZY STRIP

Braided line covered with an easily removable layer of PVC, offering exceptional resistance to abrasion and a perfect sinking action. This combination represents the best way to create the modern combi rigs, which are formed by a rigid portion followed by a softer section that ensures high mobility to hookbait and increases the anti-ejection effect. The internal braid is the new Dyna Tex compound with micro filaments, which provides high abrasion resistance. Two colours are available: Camou Brown and Camou Green, both camouflaged and very dark in tone. These are ideal for camouflage on both muddy and sandy bottoms and also on those covered with weed. To verify the true "camou effect", we recommend to wet the braid: it will totally change the colour acquiring a true camouflage look.



	COLOR	MTRS	🐟
198-60-025/10	Camo Green	16	25
198-60-035/10	Camo Green	16	35
198-60-045/10	Camo Green	16	45
198-61-025/10	Camo Brown	16	25
198-61-035/10	Camo Brown	16	35
198-61-045/10	Camo Brown	16	45

WEEDY TRAP



Weedy-Trap represents the ultimate solution to camouflage your rigs! It looks and feel like the natural weed which can be found on most carp waters, creating an unrivalled disruptive camouflage pattern when trying to disguise your end tackle where there's any weed. It's available as a leadcore or leader material. The Weedy Trap Leadcore is extremely easy to splice and features an extra heavy core to ensure your rig lays on the lakebed, this to prevent the chance of spooking any carp when visiting the swim or feeding on the baited area.

WEEDY TRAP LEADCORE	COLOR	MTRS	🐟
198-84-145/10	Natural	5	45

WEEDY TRAP HOOK LEADER	COLOR	MTRS	🐟
198-84-045/10	Natural	5	45

Weedy-Trap Leader can find a multitude of uses, and can be employed as hooklink itself or wrapped around your favourite hooklink material to dramatically improve bait presentation. In addition, Weedy Trap leaders are extremely resistant to abrasion, making them the perfect leader material when fishing heavy weed and snaggy venues.

HOOKS

the fantastic hi-carbon steel with chemically sharpened point, nothing less than the worldwide best specifications.

The K-Karp hook's range is simply complete, as it offers all patterns and sizes needed to present the whole variety of nowadays carp baits. These two pages are dedicated to the top of the range, with 6 series featuring the PTFE treatment and packed into plastic boxes having each hook clipped inside. The second part, shown in the next two pages, includes 7 series packed into traditional bags. Both have in common



The PTFE treatment provides three advantages. The surface is very slick, so that everything is built on the shank slides well; the point is protected from abrasion, thus it lasts longer; the hook is mimetic, because it doesn't cast any glare in the water.



The anti-glare surface treatment guarantees the maximum camouflage and offers additional protection to the hook, preserving the integrity of the point for a longer time.



Reinforced and chemically sharpened point last longer and have a better penetration, dramatically decreasing the chances to unhook the carp.



K-Karp hooks are subjected to a special process insuring the hook eye is perfectly closed, for maximum security and reliability of your rigs.

ANTI SNAG

Designed for heavy duty fishing conditions, such as facing snaggy waters where carp must be pulled away to avoid losing it. Consequently, its wire is oversized and the bend is forged.

PTFE treatment eases the operations connected to rig making, as well as protecting the point from abrasion. The hook shape makes it the ideal component for sinking or balanced hookbaits.

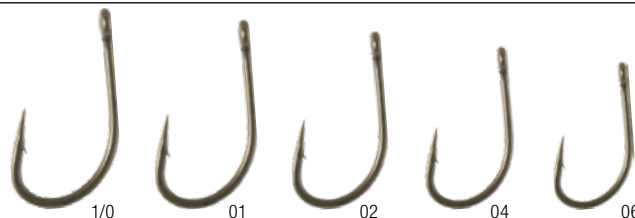

	SIZE	PCS
197-50-009/10	1/0	10
197-50-010/10	1	10
197-50-020/10	2	10
197-50-040/10	4	10
197-50-060/10	6	10

CONTINENTAL BOILIE

A classic shape since long time, very versatile for many different presentations and displaying a good compromise between weight and strength, this hook is recommended for open and snag free waters. Thanks to the deadly combination of chemically sharpened point and PTFE treatment, the new Continental Boilie is extremely well performing, and it offers the additional size 6 to match the trend of using smaller hooks also on the continent.

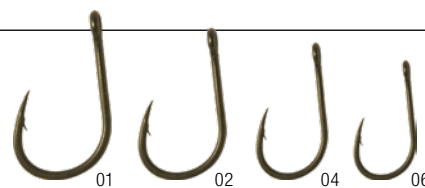

	SIZE	PCS
197-52-010/10	1	10
197-52-020/10	2	10
197-52-040/10	4	10
197-52-060/10	6	10

ANTI-EJECT



The name says all about this efficient hook, which provides safe hold in most conditions. The bent shank and long, in-turned point are the secrets behind this fantastic pattern, which is recommended for highly pressured waters because carp can hardly get rid of it. Both boilies and particles are suitable hookbaits, specially with balanced presentations. Thanks to PTFE treatment, the point is safe from abrasion, thus it lasts longer than usual.

	SIZE	PCS
197-53-020/10	2	10
197-53-040/10	4	10
197-53-060/10	6	10

TURN DOWN



This is the ideal weapon to make the most advanced rigs. Its unique shape allows an instant rotation while in the fish mouth, working extremely well in case of waters subject to high fishing pressure. It's recommended for pop-ups and balanced bottom hookbaits as well. As all the other series in the TF range, the chemically sharpened point is well protected by PTFE coating.

	SIZE	PCS
197-54-020/10	2	10
197-54-040/10	4	10
197-54-060/10	6	10



THE CHOD



Specially developed for Chod Rigs, the popular pop-up stiff presentations which have accounted for so many big catches all over Europe in the recent years. Fluorocarbon hooklink is a must to provide the correct stiffness which is so important for the efficiency of the system. Compared to former Chod series, the size 1 has been deleted in favour of size 6, which is surely more in demand today. The long, beak point is extremely sharpened for instant prick.

	SIZE	PCS
197-55-020/10	2	10
197-55-040/10	4	10
197-55-060/10	6	10

D-RIG



Purposely born to make D-Rigs, this hook shows a long shank on which the "D" finds plenty of room. The in-turned eye helps rotation when the carp tries to eject the hookbait, fitting the point safely within fish's mouth. Thanks to PTFE treatment and forged structure, the D-Rig hook performs very well and lasts quite long. It's definitely recommended for pop-up boilies and particles.

	SIZE	PCS
197-51-010/10	1	10
197-51-020/10	2	10
197-51-040/10	4	10
197-51-060/10	6	10

PERFECT HAIR TIER



Hair rig's length is quite important, as it plays a big role in the hookbait's efficiency. To tie a nice hair rig is not a big problem for most of today's anglers, but preparing many with same length is quite difficult. That's why K-Karp team has developed this useful tool, which makes it very, very easy through knotless knot. Made from stainless steel, it's quite handy and finds place in any tackle box along with all the common tools like needles and drills. A detailed instruction sheet enables the user to quickly learn the simple way to use this clever accessory.



- Form the loop at one end of the line and insert hook in the dedicated slot.
- Lock the hook firmly by turning the tool's handle.
- Fix the hair's length by moving the sliding nut.
- Insert the loop over the peg.
- Pull the line.
- Wind the line around hook's shank (6-8 turns are enough).
- Pass the other line's end through hook's eye.
- Moisten the knot and tighten it.



190-20-470/10 Perfect Hair Tier

The lines engraved along the handle help stopping the running body every 5 mm, allowing to easily fix hair's length.



SERIES 8210

The unique shape of this hook is perfect when the target are suspicious and wild carp. Long and sharp point, with medium sized barb and the in-turned eye, allow to penetrate easily in any conditions, thanks to the perfect rotation this hook can achieve once in the carp's mouth. European K-Karp team has tested this hook in really extreme conditions, and we can definitely say that this is one of the strongest hook in the market. Hi-Carbon steel, in-turned point, short shank, perfect to be used also with oversized boilies.



	SIZE	PCS
197-70-010/10	1	10
197-70-020/10	2	10
197-70-040/10	4	10
197-70-060/10	6	10

SERIES 8353 BD



This straight, long shank hook with an in turned eye, constitutes the most effective solution to very wary carp, when the long run, type D-rig is required. It seems to have the talent to produce more bites and positive hooking in these situations. The hook shape is modelled to bring an instant penetration. K-Karp hooks utilise the latest cutting system, low friction coating technology. In our opinion they are the best for strength, sharpness and durability.

	SIZE	PCS
197-68-020/10	2	10
197-68-040/10	4	10
197-68-060/10	6	10

SERIES 8354

Certainly the most favourite hook for many carp anglers, thanks to its versatility of use. The 8354 is the hook to use if you are looking for an edge when using subtle rigs, in particular with short hooklinks, and short hair-rig presentations. The extra wide gape, short shank, with a straight eye and in turned point pattern sets the hook every time. In our opinion they are the best for their balanced strength, sharpness and durability. Compared to former series, this new one has dropped size 1/0.



	SIZE	PCS
197-64-010/10	1	10
197-64-020/10	2	10
197-64-040/10	4	10
197-64-060/10	6	10

SERIES 8355 BD



Straight eyed hooks are used in many fishing situations. If you superglue the shank of these hooks to floating baits and have the point directed away from the bait then the line will come straight off the eye and away from the surface. The hooking ability of the straight eye hooks can be improved dramatically by creating a line-aligner using shrink tubing. In our opinion they are the best for strength, sharpness and durability. Compared to former series, this one has dropped size 1/0.

	SIZE	PCS
197-66-010/10	1	10
197-66-020/10	2	10
197-66-040/10	4	10
197-66-060/10	6	10



SERIES 8626 BD

SERIES 8714 BD



Bent, forged, with slightly in-turned eye to allow knotless knot. The point is chemically sharpened, has beak profile and include a micro barb for easy penetration and quick disgorging operation. The medium long shank, wide gape and light structure make it perfect for pop-up presentations of single boilies or tiger nuts. The black nickel finish offers good camouflage on the bottom, but also the best possible protection from abrasion, actually expanding point's life length.

Straight, forged, with in-turned eye, this hook shows a special bend which has been designed to ease the quick rotation towards lower lip, with consequent, immediate penetration. The Black Nickel finish is not obtrusive for carp's environment, but is also providing strong protection against abrasion, which means that the chemically sharpened needle point lasts definitely longer. The micro barb helps hook setting and speeds up disgorging operation as well.

	SIZE	PCS
197-60-010/10	1	10
197-60-020/10	2	10
197-60-040/10	4	10
197-60-060/10	6	10

	SIZE	PCS
197-62-020/10	2	10
197-62-040/10	4	10
197-62-060/10	6	10

SERIES 8723

The most popular all-rounder hook suitable for pop-up boilie presentation. The progressively curved, medium to long shank and 20 degrees down turned eye maximises strength, and the 8723 has a legendary reputation for turning, setting and staying in. In our opinion they are the best for strength, sharpness and durability.

	SIZE	PCS
197-22-040/10	4	5
197-22-060/10	6	5
197-22-080/10	8	5

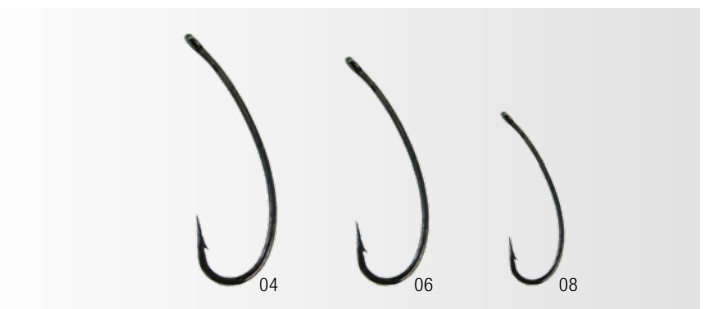

DYNA TEX

ADVANCED READY-TIED CARP RIGS

A comprehensive range of ready-tied Carp Rigs designed and approved by our Team Members and tied to perfection! Each rig has been tested for long time and assembled to our own exacting specifications. Featuring proven K-Karp components only, which include Dyna-tex Advanced hook-links and our K-Karp Hi-Carbon Hooks, the range includes rigs with different specifications and sizes to cover almost all eventualities. Even the most experienced anglers will have no problem in incorporating them into their tackle box.



TRIGGER STIFF RIG

Great Stiff Rig designed for presenting pop-ups, particles or even small sinking boilies. The hook employed is the Continental Boilie, which guarantees a perfect hook-set. The Kwik Change swivel allows to easily change the rig.

		HOOK / SIZE	LB	PCS
197-40-120/5	Trigger Stiff Rig	Continental / 02	35	2
197-40-140/5	Trigger Stiff Rig	Continental / 04	35	2
197-40-160/5	Trigger Stiff Rig	Continental / 06	25	2

**Xtreme
STIFF SKIN**



POP-UP BOILIE RIG

Pre-Tied rig designed by our team members to presenting a single popup boilie over a bed of boilies when fishing for big carp. The pop-up must be placed very close to the hook shank to have the best bait presentation possible. If necessary, it can be well employed also using sinking baits and spacing these about 5-8 mm from the hook shank. Tied with Anti-Eject hook and Xtreme hooklink.

		HOOK / SIZE	LB	PCS
197-40-220/5	Pop-Up Boilie	Anti-Eject / 02	35	2
197-40-240/5	Pop-Up Boilie	Anti-Eject / 04	35	2
197-40-260/5	Pop-Up Boilie	Anti-Eject / 06	25	2

**3X Link
TRIPLE STRUCTURE**



CONTINENTAL KD-RIG

Despite the name, this rig is coming straight from UK and it is the best solution for waters subjected to strong fishing pressure. It is has been designed for popup baits to weight directly on the hair with a small lead shot. This solution will allow the pop-up to raise just a little over the groundbait. You will be surprised of how much efficient this rig is, even in venues traditionally very difficult. The resistance is granted by the use of the K-Karp Xtreme Soft Skin.

		HOOK / SIZE	LB	PCS
197-40-920/5	Continental KD-Rig	Anti-Eject / 02	35	2
197-40-940/5	Continental KD-Rig	Anti-Eject / 04	35	2
197-40-960/5	Continental KD-Rig	Anti-Eject / 06	25	2

**FREE
EXTENDING
STOP** **Xtreme
STIFF SKIN**



SLEEVED CHOD RIG

The chod rig has become probably the most used rig in carp fishing in recent years, this is down to the fact it's very reliable, tangle-free and has produced several big catches during these years. It's tied using our Chod hooks, 100% fluorocarbon and the sleeve is transparent to perfectly conceal the bait presentation. It can be fished in conjunction with leadcore and a chod bead or straight from the mainline in its naked version.

		HOOK / SIZE	LB	PCS
197-40-320/5	Sleeved Chod	The Chod / 02	35	2
197-40-340/5	Sleeved Chod	The Chod / 04	35	2
197-40-360/5	Sleeved Chod	The Chod / 06	25	2

**FLUORO
carbon** **100%
FLUOROCARBON**



CASTING COMBI RIG

The Casting Combi Rig is a traditional combi, designed to dramatically reduce tangles during the casting. The first part is made of K-Karp XTR Fluorocarbon and the following one is made of K-Karp 3X Link, where it is applied a K-Karp Rig Aligner to achieve a blow back effect. An Anti Snag hook has been used. This rig is sequentially very technical and it is the standard for the K-Karp Team.

3X Link TRIPLE STRUCTURE **FLUORO carbon** **100% FLUOROCARBON** **FREE EXTENDING STOP**

	HOOK / SIZE	LB	PCS
197-40-820/5 Casting Combi Rig	Anti-Snag / 02	35	2
197-40-840/5 Casting Combi Rig	Anti-Snag / 04	35	2
197-40-860/5 Casting Combi Rig	Anti-Snag / 06	25	2



COMBI D-RIG

That's the rig used and approved from all our team and it has produced our best catches in the recent years. It's a great all-rounder and can be fished with bottom baits, balanced or even pop-ups. A two-inch KK fluorocarbon is tied securely using a very neat Allbright Special to the Xtreme Stiff link, thus to guarantee good anti-tangle properties and to lay down the rig on the bottom. The connection between fluoro and

braided is also protected by a rubber sinking bead. Definitely the best Combi-Rig available!

3X Link TRIPLE STRUCTURE **100% FLUOROCARBON**

	HOOK / SIZE	LB	PCS
197-40-610/5 Combi D-Rig	Anti-Snag / 01	35	2
197-40-620/5 Combi D-Rig	Anti-Snag / 02	35	2
197-40-640/5 Combi D-Rig	Anti-Snag / 04	35	2



DOWNFORCE RIG

This outstanding strong hair rig has been designed to get its maximum effectiveness with spooky carps. A K-Karp XTR Tungsten Rig Weight grants the rig is sinking, avoiding the fish to get in touch the line. It can be used with sinking or suspending baits. Built with K-Karp Xtreme Soft Skin.

FREE EXTENDING STOP **Xtreme SOFT SKIN**

	HOOK / SIZE	LB	PCS
197-40-720/5 Downforce Rig	Continental / 02	35	2
197-40-740/5 Downforce Rig	Continental / 04	35	2
197-40-760/5 Downforce Rig	Continental / 06	25	2



LINE ALIGNER RIG

The line aligner rig is designed to increase the hook turn speed by using the Line Aligner sleeves, so the point of the hook turns and catches hold extremely quickly. It's ideal when fishing for wary carp, primarily using bottom baits, balanced, or snowman presentations thanks also to the addition of the extenda bait stopper. A must for all our team!

FREE EXTENDING STOP **Xtreme STIFF SKIN**

	HOOK / SIZE	LB	PCS
197-40-510/5 Line Aligner	Anti-Snag / 01	35	2
197-40-520/5 Line Aligner	Anti-Snag / 02	35	2
197-40-540/5 Line Aligner	Anti-Snag / 04	35	2
197-40-560/5 Line Aligner	Anti-Snag / 06	25	2

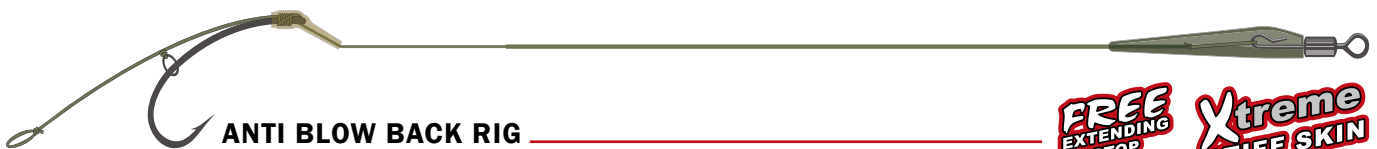

ANTI BLOW BACK RIG

The natural evolution of the original line-aligner, for presenting pop-ups or bottom baits, where a sliding micro rig ring is tied to the hair, enabling the bait to slide along the hook shank. As a result, when the bait is blown out or ejected, the ring leaves the hook point free to catch hold. Supplied with free extenda stops.

È fornito di bait stop.

FREE EXTENDING STOP **Xtreme STIFF SKIN**

	HOOK / SIZE	LB	PCS
197-40-420/5 Anti Blow Back Rig	Turn Down / 02	25	2
197-40-440/5 Anti Blow Back Rig	Turn Down / 04	25	2

DYNA TEX READY CORE

A complete range of ready tied leadcore leaders, all assembled without compromise to the highest quality standards. Ready Core are strictly hand-tied using Dyna Tex Leadcore only, this to ensure the maximum abrasion resistance. The two camou colours significantly darken down when wet, so that they can be selected to match the lake bed colour.



LEADCORE RIGS



UNI LINK

Uni-Link leaders can be assembled to use with just about any kind of lead arrangement, from free running rig to helicopter or bolt clip set up.

	COLOR	CM	LB	PCS
190-01-010/10	Camou Brown	60	45	2
190-01-020/10	Camou Green	60	45	2
190-01-030/10	Camou Brown	90	45	2
190-01-040/10	Camou Green	90	45	2

METAL CLIP

Special leader which features a strong metal bolt clip. In case the lead would get snagged, the rubber cone would slide upwards and free the carp.

	COLOR	CM	LB	PCS
190-01-130/10	Camou Brown	90	45	2
190-01-140/10	Camou Green	90	45	2

XTR CLIP

The Ready Core XTR Clip allow secure connection of the leads and feeders to your main line. They ensure that they are released in case of snagging, but in the meantime, thanks to the XTR Safety clip W/ Pins used, they also offer total reliability for extreme cast.

	COLOR	CM	LB	PCS
190-01-110/10	Camou Brown	90	45	2
190-01-120/10	Camou Green	90	45	2

SLEEVE RIG

Ideal for extreme long range fishing, thanks to the special shape of the rubber head, which carries the metal snap. Both can bear an enormous pressure.

	COLOR	CM	LB	PCS
190-01-150/10	Camou Brown	90	45	2
190-01-160/10	Camou Green	90	45	2

Hi-gravity HARDCORE LEADER

A complete range of ready tied leaders, all assembled without compromises to the highest quality standard. Ready Leaders are strictly hand-tied using Dyna Tex Hi-Gravity Leaders only, lead-free and braided with a 16 strands of ultra-heavy weight, abrasion resistant and soft fibres, that hugs the contours of the lake bed improving bait presentation and ensuring the maximum abrasion resistance.



UNI LINK

Uni-Link leaders can be assembled to use with just about any kind of lead arrangement, from free running rig to helicopter or bolt clip set up.

	COLOR	CM	LB	PCS
190-03-010/5	Camou	100	45	2

XTR CLIP

The XTR Clip is probably the most versatile and safe lead clip, offering a unique and safe bolt rig system. Suitable for long-range fishing, fish friendly and totally tangle-free.

	COLOR	CM	LB	PCS
190-03-110/5	Camou	100	45	2

METAL CLIP

The Metal Bolt Clip create an extremely safe and strong rig system, ideal for long range or big river fishing.

	COLOR	CM	LB	PCS
190-03-210/5	Camou	100	45	2



READY-CORE UNI-LINK

READY-CORE XTR CLIP

READY-CORE METAL CLIP

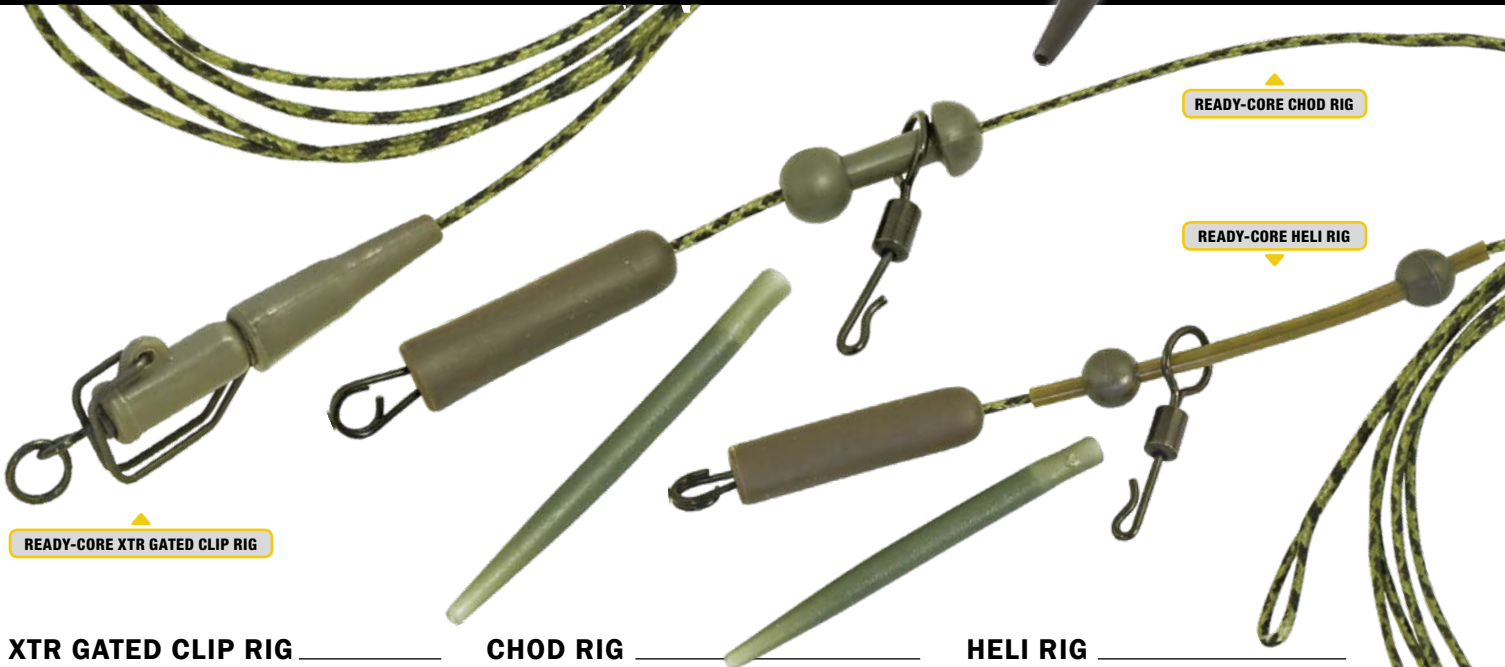

READY-CORE XTR GATED CLIP RIG

READY-CORE CHOD RIG

READY-CORE HELI RIG

XTR GATED CLIP RIG

Bolt rig set ups are the most used today, and our XTR Gated Clip is probably the most versatile and safe lead clip, offering a unique and reliable bolt rig system. The strong wire gate locks the swivel and the lead securely, while ensuring the lead will always pull free if it becomes snagged. Thus to create an extremely safe and effective bolt rig system, suitable for long range and tangle-free fishing.

	COLOR	CM	LB	PCS
190-01-210/10	Camou Green	90	45	2
190-01-220/10	Camou Brown	90	45	2

CHOD RIG

Chod set ups are the most popular presentations nowadays, very subtle on the bottom and quite safe. Our Chod Rigs are hand tied with the best components, spliced at both ends and glued for extra security. The bottom end fits an Heli Bead and Quick Link Snap to allow quick changes of the lead. It creates one of the finest pop-up presentation; using an ultra-short hooklength it is tangle-free, lays on the bottom and provides an anti-eject solution.

	COLOR	CM	LB	PCS
190-01-190/10	Camou Green	90	45	2
190-01-200/10	Camou Brown	90	45	2

HELI RIG

Ready to use Helicopter rig system, hand tied with the best components, spliced at both ends and glued for extra security. The bottom end is fitted with the Heli beads and quick link snap to easily change the lead, while the silicone stop and the swivel can be moved up the leadcore when fishing heavy silt or weed, offering great versatility and a totally tangle-free and long range set-up.

	COLOR	CM	LB	PCS
190-01-170/10	Camou Green	90	45	2
190-01-180/10	Camou Brown	90	45	2

BAIT & FEEDING



BAGS



PVA MINI BAGS

PVA STRING

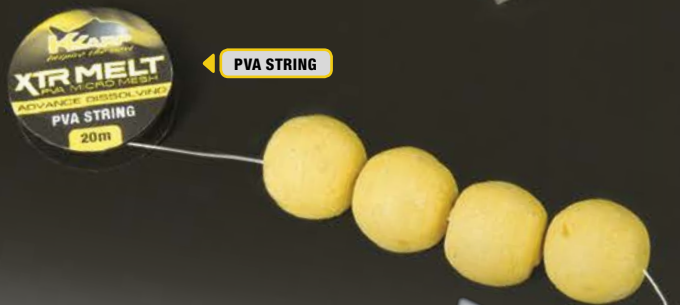

MELT PVA TAPE

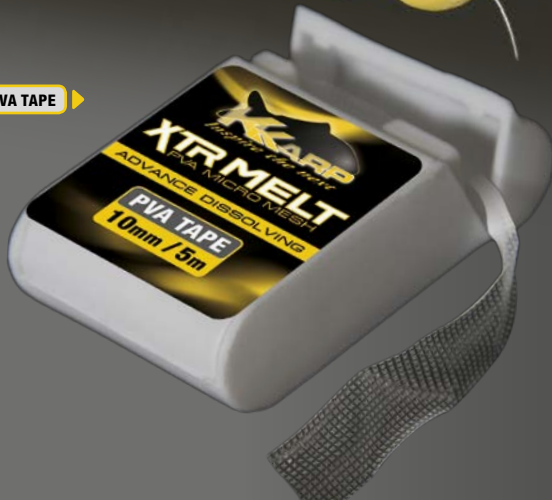

PVA BAGS

Thanks to the wide selection of sizes available this series of PVA bags can be used for any kind of fishing situation, from light marginal to long range or big river fishing, where you need to put a lot of baits on the bags. We have used premium choice PVA which is really strong but in the meantime keep really good dissolving performance even in cold water.

	SIZE	PCS
190-71-400/10	85x175 mm	15
190-71-410/10	60x220 mm	15
190-71-420/10	100x140 mm	15
190-71-430/10	85x120 mm	20

PVA MINI BAGS

The best solution possible to make small and compact PVA bag that can be attached directly to the hook, perfect to be used with pellets, crushed boilies or method. This small bags feature a PVA string in the upper part to ensure easy and safe closure of the bag. Perfect to be used in high pressured water or in any situation where accuracy is needed.

	SIZE	PCS
190-71-440/10	6x5 cm	25

PVA STRING

This PVA string can be used in many different way, like to make few boilies stringer or to close PVA bags. The premium quality PVA used give to this product good melting performance even in cold water.

	TYPE	MTRS
190-71-450/10	6 Strands	20

MELT PVA TAPE

XTR Pva Tape is very strong when dry, making it ideal for tying up the top of solid PVA bags and preparing stringers, because the solid section will actually hold the baits apart even with the force of the cast. Excellent even in cold waters.

	SIZE	MTRS
190-71-460/10	10 mm	5



PVA FUNNEL

Available in two sizes, cover a multitude of uses and can hold any different type of dry baits like pellet, boilies or method. Sold with protective tube case, 5 meters length.

	SIZE	MTRS
190-71-310/10	37 mm	5
190-71-320/10	44 mm	5



PVA REFILL



Three different size available for this PVA Funnel refill. 5 meters spool, it can be used for any kind of dry baits, such as boilies, pellets and paste.

	SIZE	MTRS
190-71-350/10	25 mm	5
190-71-360/10	37 mm	5
190-71-370/10	44 mm	5



XTR BAIT CRUSHER

The Bait Crusher has been developed to crush the hardest baits. It's the perfect tool for blending PVA Bag Mixes, Spod Mix ingredients or handfuls of boilies, the Bait Crusher does the job quickly and efficiently thanks to the stainless steel studs. Simple to use, you just fill to the level with pellets or particles of your choice and grind away until you get them to the size you want them down to, more you grind, more the bait becomes smaller.

190-71-200/5 XTR Bait Crusher



XTR BAIT CRUSHER SMALL

A nice addition to the K-Karp catalogue: a new K-Karp Bait Crusher, smaller than previous one but crushing very efficiently. The inner spikes are able to pierce, chew and grind all the boilies introduced, getting a perfect crumb. It can be used also to grind seeds and tiger nuts, to obtain very effective mix for accurate and attractive baiting. A smaller crusher is more ergonomic, allowing you to apply 100% of your harms force during crunching.

190-71-210/5 XTR Bait Crusher Small

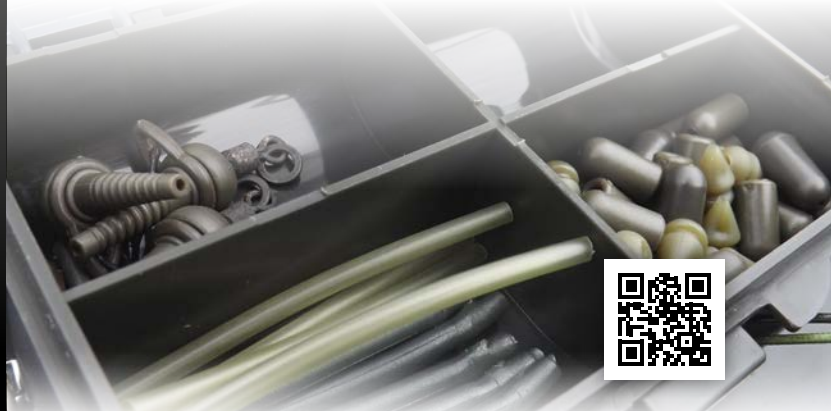

This publication does not contain all the products currently available in the K-Karp assortment. For the complete list of products, please visit our website.



Distributed by:
Trabucco International S.r.l.
Via Atene, 7 – Zona CEPIM Interporto
43010 Bianconese di Fontevivo (PR) Italy
Tel. +39 0521 618000 r.a.
Fax +39 0521 617032
E-mail: info@trabucco.it
Web: www.trabucco.it

K-Karp International reserve the right
to modify prices or specifications without
prior notice.

All product information, weights
and dimensions are approximate
and may vary or be modified.

WWW.K-KARP.COM

<http://www.facebook.com/KKarpInspirethenext>
<http://www.youtube.com/KKarpfishing>

