



Advanced simple Inverter

iMaster-E1

CAUTION

Thank you for purchasing our iMaster-E1 of inverters.

- This product is designed to drive a three-phase induction motor. Read through this instruction manual and be familiar with the handling procedure for correct use.
- Improper handling might result in incorrect operation, a short life, or even a failure of this product as well as the motor.
- Deliver this quick guide to the end user of this product. Keep this in a safe place until this product is discarded.
- For more details, refer to the instruction manual on website. (www.adtech21.com)

SAFETY

FOR THE BEST RESULTS WITH IMASTER-E1 SERIES INVERTER, READ THIS MANUAL AND ALL OF THE WARNING SIGN ATTACHED TO THE INVERTER CAREFULLY BEFORE INSTALLING AND OPERATING IT, AND FOLLOW THE INSTRUCTION EXACTLY. KEEP THIS MANUAL HANDY FOR YOUR QUICK REFERENCE.

DEFINITIONS AND SYMBOLS

A SAFETY INSTRUCTION (MESSAGE) IS GIVEN WITH A HAZARD ALERT SYMBOL AND A SIGNED WORD, **WARNING** or **CAUTION**.

EACH SIGNAL WORD HAS THE FOLLOWING MEANING THROUGHOUT THIS MANUAL.



THIS SYMBOL MEANS HAZARDOUS HIGH VOLTAGE. IT USED TO CALL YOUR ATTENTION TO ITEMS OR OPERATIONS THAT COULD BE DANGEROUS TO YOU OR OTHER PERSONS OPERATING THIS EQUIPMENT. READ THESE MESSAGES AND FOLLOW THESE INSTRUCTIONS CAREFULLY.



THIS IS THE "SAFETY ALERT SYMBOL". THIS SYMBOL IS USED TO CALL YOUR ATTENTION TO ITEMS OR OPERATIONS THAT COULD BE DANGEROUS TO YOU OR OTHER PERSONS OPERATING THIS EQUIPMENT. READ THESE MESSAGES AND FOLLOW THESE INSTRUCTIONS CAREFULLY.



WARNING INDICATES A POTENTIALLY HAZARDOUS SITUATION WHICH, IF NOT AVOIDED, CAN RESULT IN SERIOUS INJURY OR DEATH.



CAUTION INDICATES A POTENTIALLY HAZARDOUS SITUATION WHICH, IF NOT AVOIDED, CAN RESULT IN MINOR TO MODERATE INJURY, OR SERIOUS DAMAGE OF PRODUCT. THE MATTERS DESCRIBED UNDER  **CAUTION** MAY, IF NOT AVOIDED, LEAD TO SERIOUS RESULTS DEPENDING ON THE SITUATION. IMPORTANT MATTERS ARE DESCRIBED IN **CAUTION** (AS WELL AS WARNING), SO BE SURE TO OBSERVE THEM.

NOTES INDICATE AN AREA OR SUBJECT OF SPECIAL MERIT, EMPHASIZING EITHER THE PRODUCT'S CAPABILITIES OR COMMON ERRORS IN OPERATION OR MAINTENANCE.



HAZARDOUS HIGH VOLTAGE

MOTOR CONTROL EQUIPMENT AND ELECTRONIC CONTROLLERS ARE CONNECTED TO HAZARDOUS LINE VOLTAGE. WHEN SERVICING DRIVES AND ELECTRONIC CONTROLLERS, THERE MIGHT BE EXPOSED COMPONENTS WITH CASES OR PROTRUSIONS AT OR ABOVE LINE POTENTIAL. EXTREME CARE SHOULD BE TAKEN TO PROTECT AGAINST SHOCK. STAND ON AN INSULATING PAD AND MAKE IT A HABIT TO USE ONLY ONE HAND WHEN CHECKING COMPONENTS. ALWAYS WORK WITH ANOTHER PERSON IN CASE AN EMERGENCY OCCURS. DISCONNECT POWER BEFORE CHECKING CONTROLLER OR PERFORMING MAINTENANCE. BE SURE EQUIPMENT IS PROPERLY GROUNDED. WEAR SAFETY GLASSES WHENEVER WORKING ON AN ELECTRIC CONTROLLER OR ROTATING ELECTRICAL EQUIPMENT.

PRECAUTION



WARNING : THIS IS EQUIPMENT SHOULD BE INSTALLED, ADJUSTED AND SERVICED BY QUALIFIED ELECTRICAL MAINTENANCE PERSONAL FAMILIAR WITH THE CONSTRUCTION AND OPERATION OF THE EQUIPMENTS AND THE HAZARDS INVOLVED. FAILURE TO OBSERVE THIS PRECAUTION COULD RESULTSIN BODILY INJURY.



WARNING : THE USER IS RESPONSIBLE FOR ENSURING THAT ALL DRIVEN MACHINERY, DRIVE TRAIN MECHANISM NOT SUPPLIED BY ADT Co., Ltd. AND PROCESS LINE MATERIAL ARE CAPABLE OF SAFE OPERATION AT AN APPLIED FREQUENCY OF 150% OF THE MAXIMUM SELECTED FREQUENCY RANGE TO THE AC MOTOR. FAILURE TO DO SO CAN RESULT IN DESTRUCTION OF EQUIPMENT AND INJURY TO PERSONNEL SHOULD A SINGLE POINT FAILURE OCCUR.



WARNING : FOR PROTECTION, INSTALL AN EARTH LEAKAGE BREAKER WITH A HIGH FREQUENCY CIRCUIT CAPABLE OF LARGE CURRENTS TO AVOID AN UNNECESSARY OPERATION. THE GROUND FAULT PROTECTION CIRCUIT IS NOT DESIGNED TO PROTECT PERSONAL INJURY.



CAUTION: HEAVY OBJECT. TO AVOID MUSCLE STRAIN OR BACK INJURY, USE LIFTING AIDS AND PROPER LIFTING TECHNIQUES WHEN REMOVING OR REPLACING.



CAUTION : THESE INSTRUCTIONS SHOULD BE READ AND CLEARLY UNDERSTOOD BEFORE WORKING ON IMASTER-E1 SERIES EQUIPMENT.



CAUTION : PROPER GROUNDS, DISCONNECTING DEVICES AND OTHER SAFETY DEVICES AND THEIR LOCATION ARE THE RESPONSIBILITY OF THE USER AND ARE NOT PROVIDED BY ADT Co., Ltd..



CAUTION : BE SURE TO CONNECT A MOTOR THERMAL SWITCH OR OVERLOAD DEVICES TO THE IMASTER-E1 SERIES CONTROLLER TO ASSURE THAT INVERTER WILL SHUT DOWN IN THE EVENT OF AN OVERLOAD OR AN OVERHEATED MOTOR



CAUTION: ROTATING SHAFTS AND ABOVE GROUND ELECTRICAL POTENTIALS CAN BE HAZARDOUS. THEREFORE, IT IS STRONGLY RECOMMENDED THAT ALL ELECTRICAL WORK CONFORM TO THE NATIONAL ELECTRICAL CODES AND LOCAL REGULATIONS. ONLY QUALIFIED PERSONNEL SHOULD PERFORM INSTALLATION, ALIGNMENT AND MAINTENANCE. FACTORY RECOMMENDED TEST PROCEDURES, INCLUDE IN THE INSTRUCTION MANUAL, SHOULD BE FOLLOWED. ALWAYS DISCONNECT ELECTRICAL POWER BEFORE WORKING ON THE UNIT.

NOTE : POLLUTION DEGREE 2

THE INVERTER MUST BE USED IN THE ENVIRONMENT OF THE POLLUTION DEGREE 2. TYPICAL CONSTRUCTIONS THAT REDUCE THE POSSIBILITY OF CONDUCTIVE POLLUTION ARE,

- 1) THE USE OF AN UNVENTILATED ENCLOSURE.
- 2) THE USE OF A FILTERED VENTILATED ENCLOSURE WHEN THE VENTILATION IS FAN FORCED THAT IS, VENTILATION IS ACCOMPLISHED BY ONE MORE BLOWERS WITHIN THE ENCLOSURE THAT PROVIDE A POSITIVE INTAKE AND EXHAUST.

CAUTION FOR EMC (ELECTROMAGNETIC COMPATIBILITY)

TO SAFETY THE EMC DIRECTIVE AND TO COMPLY WITH STANDARD, FOLLOWS THE CHECKLIST BELOW.



WARNING

THIS EQUIPMENT SHOULD BE INSTALLED, ADJUSTED, AND SERVICED BY QUALIFIED PERSONAL FAMILIAR WITH CONSTRUCTION AND OPERATION OF THE EQUIPMENT AND THE HAZARDS INVOLVED.

FAILURE TO OBSERVE THIS PRECAUTION COULD RESULT IN BODILY INJURY.

1. THE POWER SUPPLY TO IMASTER-E1 INVERTER MUST MEET THESE SPECIFICATIONS
 - a. VOLTAGE FLUCTUATION $\pm 10\%$ OR LESS.
 - b. VOLTAGE IMBALANCE $\pm 3\%$ OR LESS.
 - c. FREQUENCY VARIATION $\pm 4\%$ OR LESS.
 - d. VOLTAGE DISTORTION THD = 10% OR LESS
2. INSTALLATION MEASURE :
 - a. USE A FILTER DESIGNED FOR IMASTER-E1 INVERTER
3. WIRING
 - a. SHIELDED WIRE (SCREENED CABLE) IS REQUIRED FOR MOTOR WIRING, AND THE LENGTH MUST BE LESS THAN 20 METERS.
 - b. THE CARRIER FREQUENCY SETTING MUST BE LESS THAN 5KHZ TO SATISFY EMC REQUIREMENTS.
 - c. SEPARATE THE MAIN CIRCUIT FROM THE SIGNAL/PROCESS CIRCUIT WIRING.
 - d. IN CASE OF REMOTE OPERATING WITH CONNECTOR CABLE, THE INVERTER DOES NOT CONFORM TO EMC
4. ENVIRONMENTAL CONDITIONS – WHEN USING A FILTER, FOLLOW THESE GUIDELINES:
 - a. AMBIENT AIR TEMPERATURE : -10 - +40 °C
 - b. HUMIDITY : 20 TO 90% RH(NON-CONDENSING)
 - c. VIBRATION : 5.9 M/S² (0.6G) 10 – 55HZ (IMASTER-E1-5.5 ~ 380KW)
 - d. LOCATION : 1000 METERS OR LESS ALTITUDE, INDOORS.
(NO CORROSIVE GAS OR DUST)

CONFORMITY TO THE LOW VOLTAGE DIRECTIVE (LVD)

THE PROTECTIVE ENCLOSURE MUST CONFORM TO THE LOW VOLTAGE DIRECTIVE.
THE INVERTER CAN CONFORM TO THE LVD BY MOUNTING INTO A CABINET OR BY ADDING
COVERS AS FOLLOWS.

1. CABINET AND COVER

THE INVERTER MUST BE INSTALLED INTO A CABINET WHICH HAS THE PROTECTION DEGREE
OF TYPE IP2X.

IN ADDITION THE TOP SURFACES OF CABINET ARE EASILY ACCESSIBLE SHALL MEET AT
LEAST THE REQUIREMENTS OF THE PROTECTIVE TYPE IP4X, OR WHICH IS CONSTRUCTED
TO PREVENT SMALL OBJECTS FROM ENTERING INVERTER.

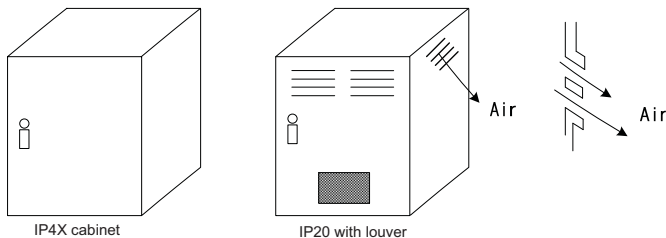

Fig 1. INVERTER CABINET

General Safety Information

1. Installation

CAUTION

- Be sure to install the unit on flame resistant material such as metal. Otherwise, there is a danger of fire.
- Be sure not to place anything highly flammable in the vicinity. Otherwise, there is a danger of fire.
- Do not carry unit by top cover, always carry by supporting base of unit. There is a risk of falling and injury.
- Be sure not to let foreign matter enter inverter such as cut wire refuse, spatter from welding, iron refuse, wire, dust, etc. Otherwise, there is a danger of fire.
- Be sure to install inverter in a place which can bear the weight according to the specifications in the text. (Chapter 6. Specifications) Otherwise, it may fall and there is a danger of injury.
- Be sure to install the unit on a perpendicular wall which is not subject to vibration. Otherwise, the inverter may fall and cause injury to personnel.
- Be sure not to install and operate an inverter which is damaged or has parts which are missing. Otherwise, there is a danger of injury.
- Be sure to install the inverter in an area which is not exposed to direct sunlight and is well ventilated. Avoid environments which tend to be high in temperature, high in humidity or to have dew condensation, as well as places with dust, corrosive gas, explosive gas, highly flammable gas, grinding-fluid mist, salt damage, etc. Otherwise, there is a danger of fire.

General Safety Information

2. Wiring

WARNING

- Be sure to ground the unit.
Otherwise, there is a danger of electric shock and/or fire.
- Wiring work should be carried out by qualified electricians.
Otherwise, there is a danger of electric shock and/or fire.
- Implement wiring after checking that the power supply is off.
Otherwise, there is a danger of electric shock and/or fire.
- After installing the main body, carry out wiring.
Otherwise, there is a danger of electric shock and/or injury.
- Do not remove the rubber bushing where wiring connections are made.
Due to the possibility that a wire may be damaged, shorted or may have a ground fault with the edge of the wiring cover.

CAUTION

- Make sure that the input voltage is:
Three phase 200 to 240V 50/60Hz
Three phase 380 to 480V 50/60Hz
- Be sure not to single phase the input.
Otherwise, there is a danger of fire.
- Be sure not to connect AC power supply to the output terminals(U, V, W).
Otherwise, there is a danger of injury and/or fire and/or damage to unit.
- Be sure not to connect a resistor to the DC terminals(PD, P and N) directly.
Otherwise, there is a danger of fire and/or damage to unit.
- Be sure to install an earth leakage breaker or the fuse(s) which is(are) the same phase as the main power supply in the operation circuit.
Otherwise, there is a danger of fire and/or damage to unit.
- As for motor leads, earth leakage breakers, and electromagnetic contactors, be sure to use equivalent ones with the specified capacity(rated).
Otherwise, there is a danger of fire and/or damage to unit.
- Do not stop operation by switching off the electromagnetic contactors on the primary or secondary sides of the inverter.
Otherwise, there is a danger of injury and/or machine breakage.
- Fasten the screws to the specified torque. Check so that there is no loosening of screws.
Otherwise, there is a danger of fire and/or injury to personnel.

General Safety Information

3. Control and operation

WARNING

- While the inverter is energized, be sure not to touch the main terminal or to check the signal or add or remove wires and/or connectors.
Otherwise, there is a danger of electric shock.
- Be sure to turn on the power supply with the front case is closed.
While the inverter is energized, be sure not to open the front case.
Otherwise, there is a danger of electric shock.
- Be sure not to operate the switches with wet hands.
Otherwise, there is a danger of electric shock.
- While the inverter is energized, be sure not to touch the inverter terminals even while the unit is not running.
Otherwise, there is a danger of electric shock.
- If the retry mode is selected, it may suddenly restart during the trip stop.
Be sure not to approach the equipment. (Be sure to design the equipment so that personnel safety will be secured even if equipment restarts.)
Otherwise, there is a danger of injury.
- Be sure not to select retry mode for equipment running up and down or traversing because there is output free-running mode in term of retry.
Otherwise, there is a danger of injury and/or machine breakage.
- Even if the power supply is cut for a short period of time, the inverter may restart operation after the power supply is restored if the operation command is given.
If a restart may incur danger to personnel, be sure to make a circuit so that it will not restart after power recovery.
Otherwise, there is a danger of injury.
- The stop key is valid only when a function is on. Ensure that there is a hard wired emergency stop that is separate from the stop key of the inverter.
Otherwise, there is a danger of injury.
- With the operation command on, if the alarm reset is ordered, the inverter can restart suddenly. Be sure to set the alarm reset after checking the operation command is off.
Otherwise, there is a danger of injury.
- Be sure not to touch the inside of the energized inverter or to put a shorting bar into it.
Otherwise, there is a danger of electric shock and/or fire.

General Safety Information

CAUTION

- The cooling fins will have a high temperature. Be sure not to touch them. Otherwise, there is a danger of getting burned.
- Low to high speed operation of the inverter can be easily set. Be sure to operate it after checking the tolerance of the motor and machine. Otherwise, there is a danger of injury.
- Install an external breaking system if needed. Otherwise, there is a danger of injury.
- If a motor is operated at a frequency outside of the standard setting value (50Hz/60Hz), be sure to check the speeds of the motor and the equipment with each manufacturer, and after getting their consent, operate them. Otherwise, there is a danger of equipment breakage.
- Check the following before and during the test run.
Was the direction of the motor correct?
Did the inverter trip for on acceleration or deceleration?
Were the RPM and frequency motor correct?
Were there any abnormal motor vibrations or noises?
Otherwise, there is a danger of machine breakage.
- The AC reactor must be installed When the power is not stable.if not, inverter can be broken.

4. Maintenance, inspection and part replacement

WARNING

- After turning off the input power supply, do not perform the maintenance and inspection for at least 10 minutes. Otherwise, there is a danger of electric shock.
- Make sure that only qualified persons will perform maintenance, inspection and/or part replacement.
(Before starting the work, remove metallic objects(wristwatch, bracelet, etc.) from a worker.
(Be sure to use insulated tools.)Otherwise, there is a danger of electric shock and/or injury.

5. Others

WARNING

- Never modify the unit.
Otherwise, there is a danger of electric shock and/or injury.

CAUTION

- Heavy object(over 15kg).
To avoid muscle strain or back injury, use lifting aids and proper lifting techniques when removing or replacing.

CONTENTS

1. GENERAL DESCRIPTION	1-1
1.1 Inspection upon Unpacking.....	1-1
1.1.1 Inspection of the unit.....	1-1
1.1.2 Instruction manual.....	1-1
1.2 Questions and Warranty of the Unit.....	1-2
1.2.1 Questions on Unit.....	1-2
1.2.2 Warranty for the unit.....	1-2
2. Installation and Wiring	2-1
2.1 Installation.....	2-1
2.1.1 Installation.....	2-2
2.2 Wiring.....	2-3
2.2.1 Terminal Connection Diagram (sink type).....	2-4
2.2.2 Main circuit wiring.....	2-7
2.2.3 Terminal connection diagram.....	2-9
3. Operation	3-1
4. Parameter Code List	4-1
4.1 About Digital Operator.....	4-1
4.1.1 Name and contents of each part of Standard-type digital operator.....	4-1
4.1.2 Key Definition and Operation of "SHIFT".....	4-4
4.2 Function List.....	4-5
4.2.1 Monitor Mode (d-group).....	4-5
4.2.2 Trip & Warning monitor mode (d-group).....	4-6
4.2.3 Basic Function Mode.....	4-7
4.2.4 Expanded Function Mode of A Group.....	4-8
4.2.5 Expanded function mode of b group.....	4-17
4.2.6 Expanded Function Mode of C Group.....	4-23
4.2.7 Expanded Function mode of H Group.....	4-27
5. Protective function	5-1
6. Specification	6-1
6.1 Standard specification list.....	6-1
6.2 The selection of braking resistor and the breaking unit.....	6-4
6.3 Dimension.....	6-5

1. GENERAL DESCRIPTION

1.1 Inspection upon Unpacking

1.1.1 Inspection of the unit

Please open the package, remove the inverter, please check the following items.

If you discover any unknown parts or the unit is damaged, please contact ADT Co., Ltd..

- (1) Make sure that the package contains one operation manual for the inverter.
- (2) Make sure that there was no damage (broken parts in the body) during transportation of the unit.
- (3) Make sure that the product is the one you ordered by checking the label specification.

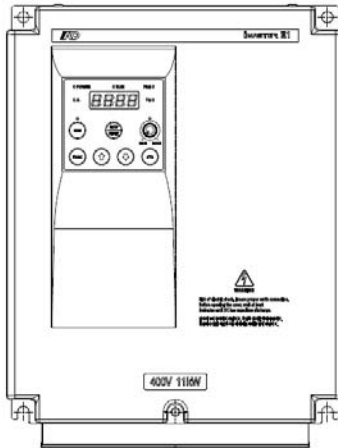

Fig1-1 Outlook of IMASTER-E1 Inverter

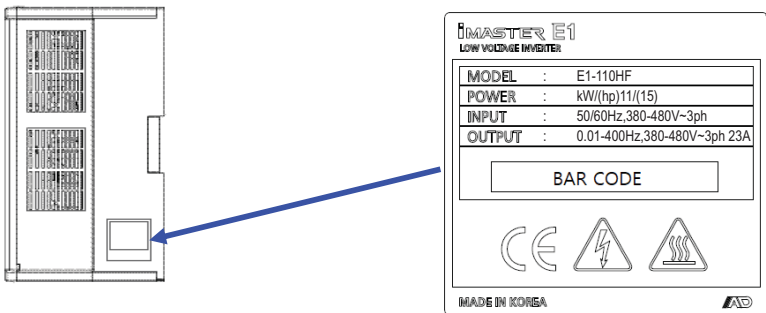

Fig1-2 Contents of Specification label

1.1.2 Instruction manual

This instruction manual is the manual for the IMASTER-E1 inverters.

Before operation of the inverter, read the manual carefully. After reading this manual, keep it on hand for future reference

1.2 Questions and Warranty of the Unit

1.2.1 Questions on Unit

- If you have any questions regarding damage to the unit, unknown parts or for general inquiries, please contact your LOCAL ADT Co., Ltd. BRANCH with the following information.

- (1) Inverter Model
- (2) Production Number (Serial No.)
- (3) Date of purchase
- (4) Reason for Calling
 - ① Damaged part and its condition etc.
 - ② Unknown parts and their contents etc.

1.2.2 Warranty for the unit

- (1) The warranty period of the unit is one year after the purchase date. However the warranty will be void if the fault is due to;
 - ① Incorrect use as directed in this manual, or attempted repair by unauthorized personnel.
 - ② Any damage sustained other than from transportation (Which should be reported immediately).
 - ③ Using the unit beyond the limits of the specifications.
 - ④ Natural Disasters : Earthquakes, Lightning, etc
- (2) The warranty is for the inverter only, any damage caused to other equipment by malfunction of the inverter is not covered by the warranty.
- (3) Any examination or repair after the warranty period (one-year) is not covered. And within the warranty period any repair and examination which results in information showing the fault was caused by any of the items mentioned above, the repair and examination costs are not covered. If you have any questions regarding the warranty, please contact either your Local ADT Co., Ltd. Branch.

2. Installation and Wiring

2.1 Installation

 **CAUTION**

- Be sure to install the unit on flame resistant material such as metal. Otherwise, there is a danger of fire.
- Be sure not to place anything flammable in the vicinity. Otherwise, there is a danger of fire.
- Do not carry the unit by the top cover, always carry by supporting the base of unit. There is a risk of falling and injury.
- Be sure not to let foreign matter enter such as cut wire refuse, spatter from welding, iron refuse, wire, dust, etc. Otherwise, there is a danger of fire.
- Be sure to install the inverter in a place which can bear the weight according to the specifications in the text. Otherwise, it may fall and result in possible injury.
- Be sure to install the unit on a perpendicular wall which is not subject to vibration. Otherwise, the inverter may fall and cause injury to personnel.
- Be sure not to install and operate an inverter which is damaged or parts of which are missing. Otherwise, there is a danger of injury.
- Be sure to install the inverter in an area which is not exposed to direct sunlight and is well ventilated. Avoid environments which tend to be high in temperature, high in humidity or to have dew condensation, as well as places with dust, corrosive gas, explosive gas, inflammable gas, grinding-fluid mist, salt damage, etc. Otherwise, there is a danger of fire.

2.1.1 Installation

(1) Transportation

This inverter has plastic parts. So handle with care.

Do not over tighten the wall mounting fixings as the mountings may crack, causing a risk of falling.

Do not install or operate the inverter if there appears to be damaged or parts missing.

(2) Surface for the mounting of inverter

The temperature of the inverter heatsink can rise very high.

The surface, to which the inverter will be mounted, must be made of a non-flammable material (i.e. steel) due to the possible risk of fire. Attention should also be made to the air gap surrounding the inverter.

Especially, when there is a heat source such as a breaking resistor or reactor.

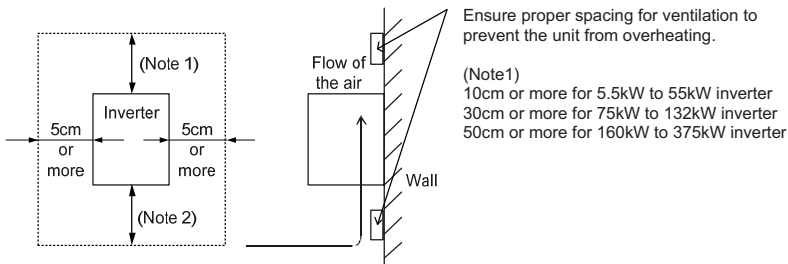

Fig 2- 1Surface for the mounting of inverter

(3) Operating Environment-Ambient Temperature

The ambient temperature surrounding the inverter should not exceed the allowable temperature range (14 to 122°F, -10 to 50°C).

The temperature should be measured in the air gap surrounding the inverter, shown in the diagram above. If the temperature exceeds the allowable temperature, component life will become shortened especially in the case of the Capacitors.

(4) Operating Environment-Humidity

The humidity surrounding the inverter should be within the limit of the allowable percentage range (20% to 90% / RH).

Under no circumstances should the inverter be in an environment where there is the possibility of moisture entering the inverter.

Also avoid having the inverter mounted in a place that is exposed to the direct sunlight.

(5) Operating Environment-Air

Install the inverter in a place free from dust, corrosive gas, explosive gas, combustible gas, mist of coolant and sea damage.

2.2 Wiring

WARNING

- Be sure to ground the unit.
Otherwise, there is a danger of electric shock and/or fire.
- Wiring work should be carried out by qualified electricians.
Otherwise, there is a danger of electric shock and/or fire.
- Implement wiring after checking that the power supply is off.
Otherwise, there is a danger of electric shock and/of fire.
- After mounting the inverter, carry out wiring.
Otherwise, there is a danger of electric shock and/or injury.
- Do not remove the rubber bushings where wiring connections are made.
(5.5 to 22kW) Due to the possibility that a wire may be damaged, shorted
or may have a ground fault with the edge of the wiring cover.

CAUTION

- Make sure that the input voltage is:
Three phase 200 to 240V 50/60Hz
(Model : IMASTER-E1-055LF/075LFP~220LF)
Three phase 380 to 480V 50/60Hz
(Model : IMASTER-E1-055HF/075HFP~3500HF/3800HFP)
- Be sure not to power a three-phase-only inverter with single phase power.
Otherwise, there is a danger of fire.
- Be sure not to connect AC power supply to the output terminals(U, V, W).
Otherwise, there is a danger of injury and/or fire and/or damage to unit.
- Be sure not to connect a resistor to the DC terminals(PD, P) directly.
Otherwise, there is a danger of fire and/or damage to unit..
- Be sure to set a earth leakage breaker or the fuse(s) which is(are) the same
phase as the main power supply in the operation circuit.
Otherwise, there is a danger of fire and/or damage to unit..
- As for motor leads, earth leakage breakers, and electromagnetic contactors,
be sure to use equivalent ones with the specified capacity(rated).
Otherwise, there is a danger of fire and/or damage to unit..
- Do not stop operation by switching off the electromagnetic contactors on the
primary or secondary sides of the inverter.
Otherwise, there is a danger of injury and/or machine breakage.
- Fasten the screws to the specified torque. Check so that there is no loosening of
screws.
Otherwise, there is a danger of fire and/or damage to unit..

2.2.1 Terminal Connection Diagram (sink type)

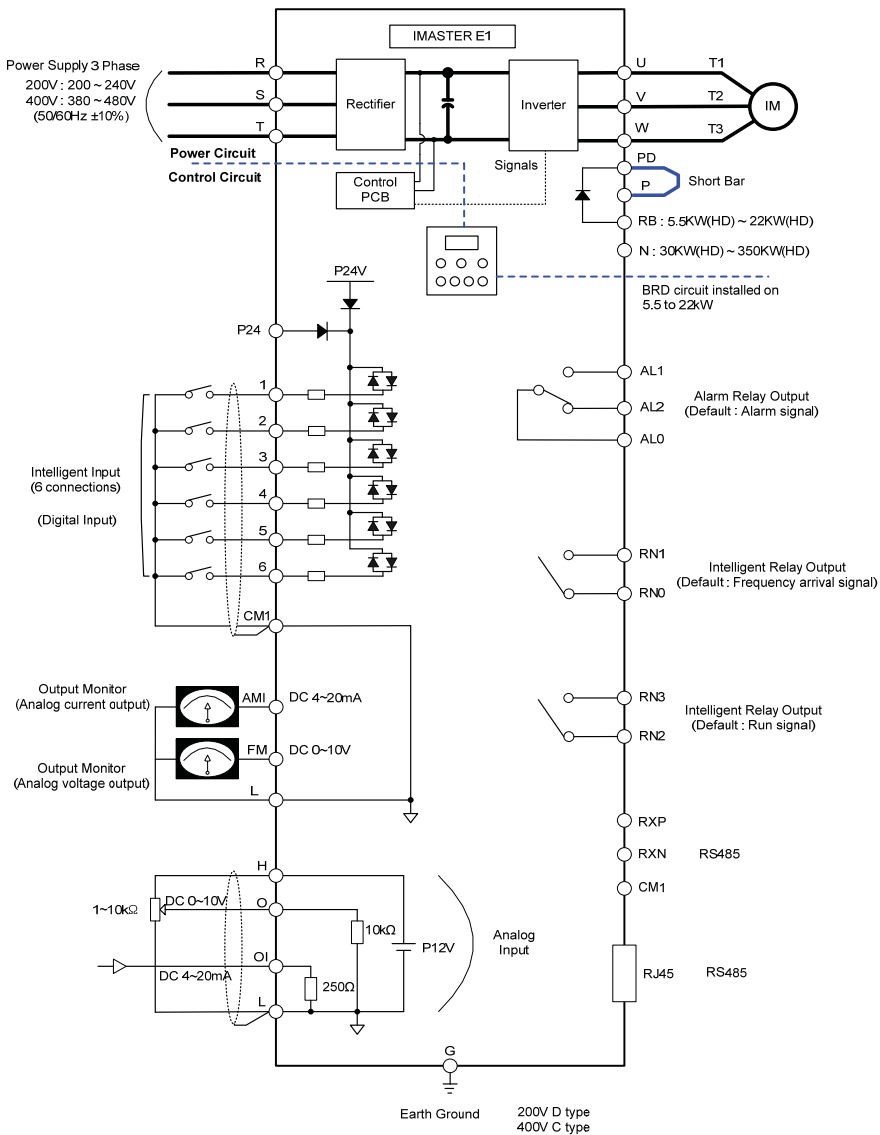

Fig.2-3 Terminal Connection Diagram (sink type)

(1) Explanation of main circuit Terminals

Symbol	Terminal Name	Explanation of contents
R,S,T (L1,L2,L3)	Main power	Connect alternating power supply. When using regenerative converter and RG series, don't connect.
U,V,W (T1,T2,T3)	Inverter output	Connect three-phase motor.
PD,P (+1,+)	D.Creactor	Remove the short bar between PD and P, connect optional Power factor reactor (DCL).
P, RB (+, -)	External braking resistor	Connect optional External braking resistor. (Please install the optional External braking resistor for 5.5~22kW model.)
P, N	External braking Unit	Connect optional External braking Unit (Please install the optional External braking Unit for 30~350kW model.)
G	Inverter earth terminals	Grounding terminal.

Table 2-1Explanation of main circuit terminals

(2) Control circuit Terminals

Signal	Terminal Symbol	Terminal name	Terminal function
Input signal	P24	Interface power	24VDC \pm 10%, 35mA
	6 (RS)	Intelligent Input Terminal	Contact input : Close : ON (operating) Open : OFF(stop) Minimum ON TIME :12msor more
	5 (AT)		
	4 (CF2)	Forward run command(FW), Reverse runcommand(RV), multi-speed commands1-4(CF1-4),2-stage accel/decel(2CH), Reset(RS),Terminal software lock(SFT), Unattended start protection(USP), Current input selection(AT),Jogging operation(JG), External trip(EXT), 3 wires input(STA,STP,F/R) Up/Down(Up, Down), Local Keypad Operation(O/R), Local Terminal Input Operation(T/R), PID Integral Reset(PIDIR), PID Disable(PIDD)	
	3 (CF1)		
	2 (RV)		
	1 (FW)		
CM1	Common terminal for input or monitor signal		
Monitor signal	FM	Analog Monitor (Frequency, Current, Voltage, Power)	0~10Vdc, Max 1mA
	AMI	Analog Monitor (Frequency, Current, Voltage, Power)	4~20mA, Max 250 Ω
Frequency command signal	H	Frequency power	12VDC
	O	Frequency command power terminal (voltage)	0-10VDC, Input Impedance 10k Ω
	OI	Frequency command terminal (current)	4-20mA, Input Impedance 250 Ω
	L	Analog power common	
No.1 Channel Communication terminal	RJ-45	Basic Communication connect	Basic RS-485 Communication terminal
No.2 Channel Communication terminal	RXP	RS-485 Communication + terminal	No.2 Channel RS-485 Communication terminal
	RXN	RS-485 Communication - terminal	

Signal	Terminal Symbol	Terminal name	Terminal function
Output signal	RN0 RN1	Intelligent output terminal: Run status signal(RUN), Frequency arrival signal(FA1), Set frequency arrival signal(FA2), Overload advance notice signal(OL), PID error deviation signal(OD), Alarm signal(AL)	Contact rating: AC 250V2.5A (resistor load) 0.2A (inductor load) DC 30V 3.0A (resistor load) 0.7A (inductor load)
	RN2 RN3		
Intelligent Output signal	AL0 AL1 AL2	Alarm output terminal: Run status signal(RUN), Frequency arrival signal(FA1), Set frequency arrival signal(FA2), Overload advance notice signal(OL), PID error deviation signal(OD), Alarm signal(AL) Alarm output signals : at normal status, power off : AL0-AL2 (closed) at abnormal status : AL0-AL1(closed)	Contact rating: AC 250V2.5A (resistor load) 0.2A (inductor load) DC 30V 3.0A (resistor load) 0.7A (inductor load)

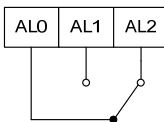

Table2-2Control circuit Terminals

2.2.2 Main circuit wiring

The wiring of main circuit terminals for the inverter are in the following pictures.

Wiring of terminals	Corresponding type	Screw Size	Width(mm)
	MASTER-E1-055LF/075LFP MASTER-E1-075LF/110LFP MASTER-E1-055HF/075HFP MASTER-E1-075HF/110HFP MASTER-E1-110HF/150HFP	M4	10.6
	MASTER-E1-110LF/150LFP	M5	13
	MASTER-E1-150LF/185LFP MASTER-E1-150HF/185HFP MASTER-E1-185HF/220HFP MASTER-E1-220HF/300HFP	M5	13
	MASTER-E1-185LF/220LFP MASTER-E1-220LF	M6	17
	MASTER-E1-300HF/370HFP MASTER-E1-370HF/450HFP	M6	17
	MASTER-E1-450HF/550HFP MASTER-E1-550HF/750HFP	M8	22
	MASTER-E1-750HF/900HFP MASTER-E1-900HF/1100HFP	M8	29

Wiring of terminals	Corresponding type	Screw Size	Width (mm)
	IMASTER-E1-055LF/075LFP IMASTER-E1-075LF/110LFP IMASTER-E1-055HF/075HFP IMASTER-E1-075HF/110HFP IMASTER-E1-110HF/150HFP	M4	10.6
	IMASTER-E1-1100HF/1320HFP IMASTER-E1-1320HF/1600HFP	M10	30
	IMASTER-E1-1600HF/2000HFP IMASTER-E1-2200HF/2500HFP	M10	38
	IMASTER-E1-2800HF/3200HFP IMASTER-E1-3500HF/3800HFP	M13	38

Table 2-3Wiring of main circuit terminals

2.2.3 Terminal connection diagram

(1) Terminal connection diagram

- ① The control circuit terminal of inverters is connected with the control board in unit.



IMASTER-E1#1 ~ #4 (5.5kW(HD) ~ 350kW(HD))

Fig 2-5Terminal connection diagram

(2) Wiring

- ① Above control signals are insulated to its power lines(R, S, T, U, V, W).
Do not connect those signalsto power lines or ground.
- ② Use twisted screened cable, for the input and output wires of the control circuit terminals.
Connect the screened cable to the common terminal.
- ③ Limit the connection wires to 65 feet.
- ④ Separate the control circuit wiring from the main power and relay control wiring.

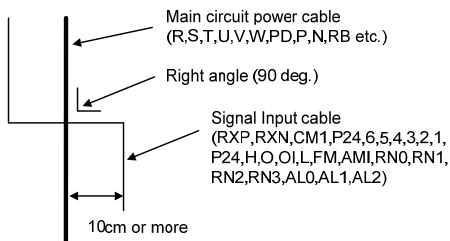

- ⑤ When using relays for the FW terminal or an intelligent input terminal use a control relay that is designed to work with 24Vdc.
- ⑥ When a relay is used as an intelligent output, connect a diode for surge protection parallel to the relay coil.
- ⑦ Do not short the analog voltage terminals H and L or the internal power terminals P24 and all CM1's. Otherwise there is risk of Inverter damage.
- ⑧ When connecting a thermistor to the TH and all CM1's terminal, twist the thermistor cables and separate them from the rest. Limit the connection wires to 65 feet

3. Operation

 **WARNING**

- Be sure not to touch the main terminal or to check the signal add or remove wires and/or connectors.
Otherwise, there is a danger of electric shock.
- Be sure not to turn the input power supply on until after front case is closed.
While the inverter is energized, be sure not to remove the front cover.
Otherwise, there is a danger of electric shock.
- Be sure not to operate the switches with wet hands.
Otherwise, there is a danger of electric shock.
- While the inverter is energized, be sure not to touch the inverter terminals even while the unit is not running.
Otherwise, there is a danger of electric shock.
- If the retry mode is selected, it may suddenly restart during the trip stop.
Be sure not to approach the equipment.(Be sure to design the equipment so that personnel safety will be secured even if equipment restarts.)
Otherwise, there is a danger of injury.
- Be sure not to select retry mode for up and down equipment or traveling equipment, because there is an output free-running mode in term of retry.
Otherwise, there is a danger of injury and/or machine breakage
- Even if the power supply is cut for a short period of time, the inverter may restart operation after the power supply is restored if the operation command is given.
If a restart may incur danger to personnel, be sure to make a circuit so that it will not restart after power recovery.
Otherwise, there is a danger of injury.
- The stop key is valid only when a function is on. Ensure that there is a hard wired emergency stop that is separate from the stop key of the inverter.
Otherwise, there is a danger of injury.
- With the operation command on, if the alarm reset is ordered, the inverter can restart suddenly. Be sure to set the alarm reset after checking the operation command is off.
Otherwise, there is a danger of injury.
- Be sure not to touch the inside of the energized inverter or to put a bar into it.
Otherwise, there is a danger of electric shock and/or fire.

4. Parameter Code List

4.1 About Digital Operator

4.1.1 Name and contents of each part of Standard-type digital operator

(1) Part name

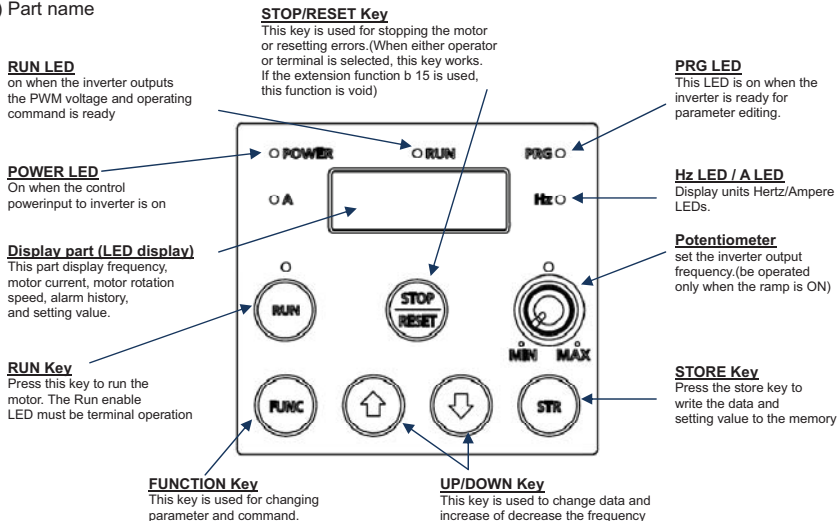
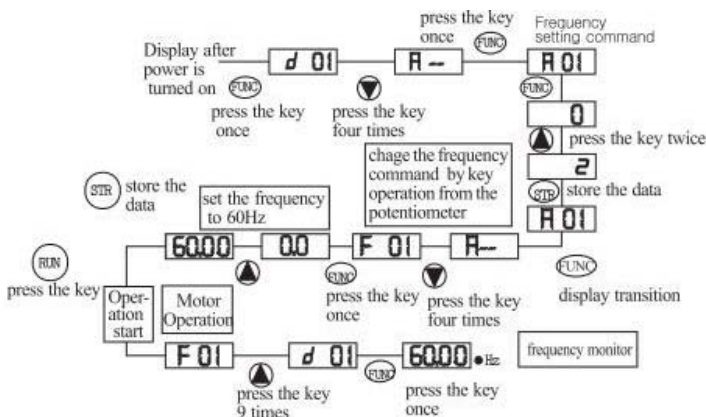

Fig.4-1 LED Type Digital Operator

(2) Operation procedure

- ① Example that the frequency is set from potentiometer to the standard operator and the equipment starts running)



② Key Description

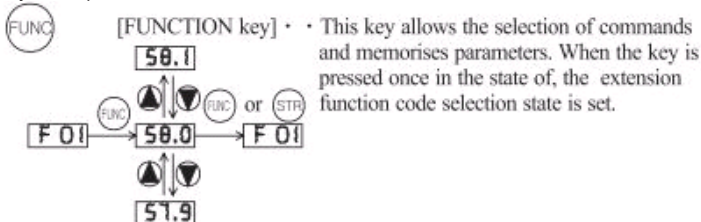

▲ ▼ [UP/DOWN key] · · The key are used to select the command and change the data

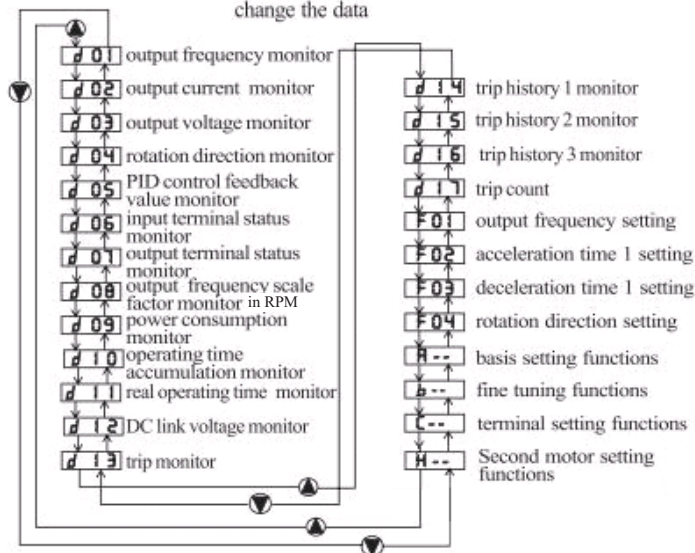

(RUN) [RUN key] · · This key starts the run.

The set value of [F 04] determines a forward run or a reverse run.



[STOP/RESET key] · · This key stops the run

When a trip occurs, this key becomes the reset key.

③ Extended function mode navigation map

Using the / key to enter the expanded function mode, select expanded function command NO. in | and mode.

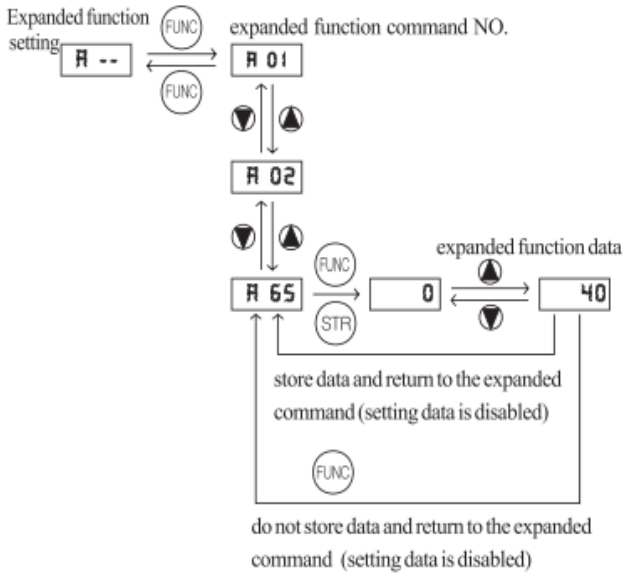

④ Display description:

When the inverter is turned on, one of the display group can appear according to the setting value of b30 (display code setting)

4.1.2 Key Definition and Operation of “SHIFT”

Definition : The“SHIFT”function is enable to press both up and down key simultaneously. The left most 7-segment digit is blinked and if press store key, the blinked segment moves to the right digit. When the 'store' key is pressed, it moved to the right digits again. When the right most digit is blinked and press the 'store' key, it turn back to the function code display.

1. Display digit movement

- Press the UP key and DOWN key at the same time in data setting mode.
→ Change Scroll-mode to Shift-mode

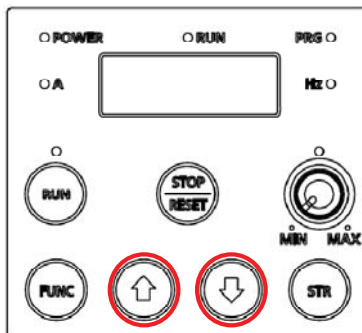

2. Data setting method

Stop in target group using UP/DOWN key → Press the function key, Change to data setting mode.

Press the UP key and DOWN key at the same time. → First number is flashing on the left

Change the data using UP/DOWN key → Press the Store-key
→ Third number is flashing

Change the data using UP/DOWN key → Press the Store-key
→ Second number is flashing

Change the data using UP/DOWN key → Press the Store-key
→ First number is flashing

Change the data using UP/DOWN key → Press the Store-key
→ Target function code is setting

4.2 Function List

4.2.1 Monitor Mode (d-group)

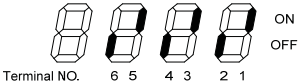
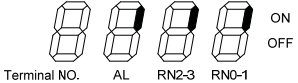
Func-code	Name	Description
d01	Output frequency monitor	Real-time display of output frequency to motor, from 0.00 to 400.0 Hz, "Hz" LED ON
d02	Output current monitor	Real-time display of output current to motor, from 0.0 to 9999A, "A" LED ON.
d03	Output voltage monitor	Real-time display of output voltage to motor
d04	Rotation direction monitor	Three different indications: "F"..... Forward Run "□".... Stop "r"..... Reverse Run
d05	PID feedback monitor	Displays the scaled PID process variable (feedback) value (A50 is scale factor)
d06	Intelligent input terminal status	Displays the state of the intelligent input terminals:  Terminal NO. 6 5 4 3 2 1 ON OFF
d07	Intelligent output terminal status	Displays the state of the intelligent output terminals:  Terminal NO. AL RN2-3 RN0-1 ON OFF
d08	RPM output monitor	0 ~ 65530 (RPM) (=120 x d01 x b14) /H14
d09	Power consumption monitor	0 ~ 999.9 (kW)
d10	Operating time accumulation monitor(hour)	0 ~ 9999 (hr)
d11	Real operating time monitor (minute)	0 ~ 59 (min)
d12	DC link voltage	0 ~ 999 (V)

4.2.2 Trip & Warning monitor mode (d-group)

Func-code	Name	Description
d13	Trip event monitor	Displays the current trip event <ul style="list-style-type: none"> · Display method <ul style="list-style-type: none"> Alarm reason ↓ press the UP key <ul style="list-style-type: none"> Output frequency at alarm event ↓ press the UP/DOWN key <ul style="list-style-type: none"> Output current at alarm event ↓ press the UP/DOWN key <ul style="list-style-type: none"> DC link voltage at alarm event ↓ press the FUNC key <ul style="list-style-type: none"> "d13" display · No trip event
d14	Trip history 1 monitor	Displays the previous first trip event
d15	Trip history 2 monitor	Displays the previous second trip event
d16	Trip history 3 monitor	Displays the previous third trip event
d17	Trip count	Displays the trip accumulation count

4.2.3 Basic Function Mode

Func-code	Name	Run-time Edit	Description	Defaults
F01	Output frequency setting	O	Standard default target frequency that determines constant motor that determines constant motor speed. setting range is 0.00 to 400.0Hz. (In the case of sensorless vector control, setting range is 0.00 to 300.0Hz.) (1) frequency setting from UP/DOWN key of digital operator. (2) Multi-step speed By combining frequency reference and intelligent input terminal ON/OFF, up to 16 step of speed can be set. (3) Remote operator (NOP), control terminal input (O-L, OI-L). Frequency reference by the local potentiometer can be monitored..	0.00Hz
F02	Acceleration time1 setting	O	0.1 ~ 3000sec Minimum setting range 0.1 ~ 999.9 --- by 0.1sec 1000 ~ 3000 --- by 1sec	30.0sec
F03	Deceleration time 1 setting	O	0.1~3000sec Minimum setting range 0.1 ~ 999.9 --- by 0.1sec 1000 ~ 3000 --- by 1sec	30.0sec
F04	Rotation direction setting	X	Two options: select codes: 0... Forward run 1... Reverse run	0
A--	Extended function of A group setting	-	Basic setting functions setting range : A01 ~ A85.	-
b--	Extended function of b group setting	-	Fine tuning functions Setting range : b01 ~ b33	-
C--	Extended function of C group setting	-	Terminal setting functions Setting range : C01 ~ C27	-
H--	Extended function of H group setting	-	Sensorless vector setting functions Setting range : H01 ~ H15.	-

Note) If you set the carrier frequency less than 2kHz, acceleration / deceleration time delays approximately 500msec.

4.2.4 Expanded Function Mode of A Group

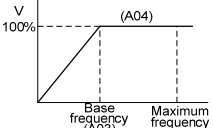
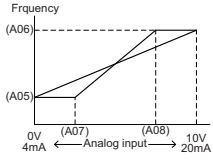
Func-code	Name	Run-time Edit	Description	Defaults
Basic parameter settings				
A01	Frequency command (Multi-speedcommand method)	X	Four options: select codes: 0.... Keypad potentiometer 1.... Control terminal input 2.... Standard operator 3.... Remote operator(1 ST communication-RJ45) 4.... Remote operator(2 ND communication-terminal)	1
A02	Run command	X	Set the method of run commanding: 0.... Standard operator 1.... Control terminal input 2.... Remote operator(1 ST communication-RJ45) 3.... Remote operator(2 ND communication-terminal)	1
A03	Base frequency setting	X	Settable from 0 to maximum frequencyin units of 0.01Hz 	60.00Hz
A04	Maximum frequency setting	X	Settable from the base frequency [A03] up to 400Hz in units of 0.01 Hz. In the case of sensorless vector control, possible for driving to 300Hz	60.00Hz
Analog Input Settings				
A05	External frequencysetting start (O, OI)	X	Start frequency provided when analog input is 0V (4mA) can be set in units of 0.01Hz setting range is 0 to maximum frequency(A04) 	0.00Hz
A06	External frequencysetting end (O, OI)	X	End frequency provided when analog input is 10V(20mA) can be set in units of 0.01Hz. setting range is 0 to maximum frequency(A04)	0.00Hz
A07	External frequencystart rate setting (O, OI)	X	The starting point(offset) for the active analog input range(0 ~ 10V, 4mA ~ 20mA) setting range is 0 to 100% in units of 0.1%	0.0%
A08	External frequencyend rate setting (O, OI)	X	The ending point(offset) for the active analog input range(0 ~ 10V, 4mA ~ 20mA) setting range is 0 to 100% in units of 0.1%	100.0%

Func-code	Name	Run-time Edit	Description	Defaults
A09	External frequency start pattern setting	X	Two options: select codes: 0--- start at start frequency 1--- start at 0Hz 	0
A10	External frequency sampling setting	X	Range n = 1 to 8, where n = number of samples for average	4
Multi-speed Frequency Setting				
A11 ~ A25	Multi-speed frequency setting	O	Defines the first speed of a multi-speed profile, range is 0 to maximum frequency (A04) in units of 0.01Hz. Setting range is 1-speed (A11) to 15-speed (A25). Speed0: volume setting value	speed1: 5Hz speed2: 10Hz speed3: 15Hz speed4: 20Hz speed5: 30Hz speed6: 40Hz speed7: 50Hz speed8: 60Hz etc. 0Hz
A26	Jogging frequency setting	O	Defines limited speed for jog, range is 0.5 to 10.00Hz in units of 0.01Hz. The jogging frequency is provided safety during manual operation.	0.50Hz
A27	Jogging stop operation selection	X	Define how end of jog stops the motor: three options: 0.... Free-run stop 1.... Deceleration stop (depending on deceleration time) 2.... DC injection braking stop (necessary to set DC injection braking)	0
V/F Characteristics				
A28	Torque boost mode selection	X	Two options: 0.... Manual torque boost 1.... Automatic torque boost	0
A29	Manual torque boost setting	O	Can boost starting torque between 0 and 50% above normal V/F curve, from 0 to 1/2 base frequency Be aware that excessive torque boost can cause motor damage and inverter trip. 	1.0%

Func-code	Name	Run-time Edit	Description	Defaults
A30	Manual torque boost frequency setting	O	Sets the frequency of the V/F breakpoint A in graph for torque boost. Range is 0.0 to 100.0%	10.0%
A31	V/F characteristic curve selection	X	<p>Two available V/F curves: three select codes: 0... Constant torque 1... Reduced torque (reduction of the 1.7th power) 2... Sensorless vector control</p>	0
A32	V/F gain setting	O	<p>Sets output voltage gain of the inverter from 20 to 110% It is proper to set the voltage gain above 100% in case the rated output voltage is lower than the rated input voltage</p>	100.0%
DC Injection Braking Settings				
A33	DC injection braking function selection	X	Sets two options for DC injection braking 0... Disable 1... Enable	0
A34	DC injection braking frequency setting	X	The frequency at which DC injection braking occurs, range is 0.50 to 10.00 Hz in units of 0.01Hz	0.50Hz
A35	DC injection braking output delay time setting	X	<p>The delay from the end of Run command to start of DC injection braking (motor free runs until DC injection braking begins). Setting range is 0.0 to 5.0sec in units of 0.1set.</p>	0.0sec
A36	DC injection braking force setting	X	Applied level of DC injection braking force settable from 0.0 to 100.0% in units of 0.1%	50.0% ($\leq 22\text{kW}$) 10.0% ($\geq 30\text{kW}$) 7.0% ($\geq 160\text{kW}$)
A37	DC injection braking time setting	X	Sets the duration for DC injection braking, range is 0.0 to 10.0 seconds in units of 0.1sec.	0.0sec

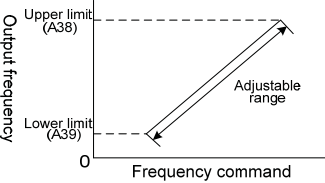
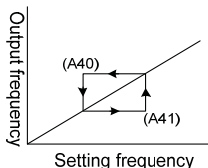
Func-code	Name	Run-time Edit	Description	Defaults
Frequency-related Functions				
A38	Frequency upper limit setting	X	<p>Sets a limit on output frequency less than the maximum frequency(A04). Range is frequency lower limit(A39) to maximum frequency(A04) in units of 0.01Hz.</p> 	0.00Hz
A39	Frequency lower limit setting	X	<p>Sets a limit on output frequency greater than zero. Range is 0.00 to frequency upper limit(A38) in units of 0.01Hz</p>	0.00Hz
A40 A42 A44	Jump(center) frequency setting	X	<p>Up to 3 output frequencies can be defined for the output to jump past to avoid motor resonances (center frequency) range is 0.00 to maximum frequency(A04) in units of 0.01Hz..</p>	0.00Hz
A41 A43 A45	Jump(hysteresis) frequency width setting	X	<p>Defines the distance from the center frequency at which the jump around occurs. Range is 0.00 to 10.00Hz in units of 0.01Hz</p> 	0.00Hz

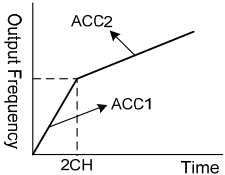
Func-code	Name	Run-time Edit	Description	Defaults
Automatic Voltage Regulation (AVR) Function				
A52	AVR function selection	X	Automatic (output) voltage regulation, selects from three type of AVR functions three option codes: 0... Constant ON 1... Constant OFF 2... OFF during deceleration The AVR feature keeps the inverter output waveform at a relatively constant amplitude during power input fluctuations	2
A53	Motor inputvoltage setting	X	200V class inverter settings: 200/220/230/240 400V class inverter settings: 380/400/415/440/460/480	LF Model 220V HF Model (Note3)
Second Acceleration and Deceleration Functions				
A54	Second acceleration time setting	O	Duration of 2nd segment of acceleration, range is 0.1 to 3000 sec. Second acceleration can be set by the [2CH] terminal input or frequency transition setting	30.0sec
A55	Second deceleration time setting	O	Duration of 2nd segment of deceleration, motor range is 0.1 to 3000 sec. Second acceleration can be set by the [2CH] terminal input or frequency transition setting	30.0sec
A56	Two stageacce1/dece1 switching methodselection	X	Two options for switching from 1st to 2nd accel/decel: 0.... 2CH input from terminal 1.... transition frequency 	0
A57	Acc1 to Acc2frequency transition point	X	Output frequency at which Accel 1 switches to Accel 2, range is 0.00 to maximum frequency(A04) in units of 0.01Hz.	0.00Hz
A58	Decel 1 to Decel 2 frequency transition point	X	Output frequency at which Decel 1 switches to Decel 2, range is 0.00 to maximum frequency(A04) in units of 0.01Hz.	0.00Hz

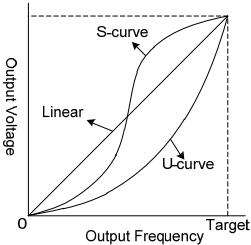
Func-code	Name	Run-time Edit	Description	Defaults
A59	Acceleration curve selection	X	<p>Set the characteristic curve of Acc1 and Acc2, two options:.</p> <p>0 --- Linear 1 --- S-curve 2 --- U-curve</p> 	0
A60	Deceleration curve setting	X	<p>Set the characteristic curve of dec1 and dec2, two options:.</p> <p>0 --- Linear 1 --- S-curve 2 --- U-curve</p>	0
A61	Input voltage offset setting	O	<p>Set the voltage offset for external analog signal input signal adjustment Range is -10.0 to 10.0 [%]</p>	0.0%
A62	Input voltage Gain setting	O	<p>Set the voltage gain for external analog signal input signal adjustment Range is 0.0 to 200.0 [%]</p>	100.0%
A63	Input current offset setting	O	<p>Set the current offset for external analog signal input signal adjustment Range is -10.0 to 10.0 [%]</p>	0.0%
A64	Input current Gain setting	O	<p>Set the current gain for external analog signal input signal adjustment Range is 0.0 to 200.0 [%]</p>	100.0%
A65	FAN operation mode	X	<p>Se the FAN operation mode 0: always ON 1: ONin the run time</p>	0

Note3:055HF~1320HF/075HFP~1600HFP : 380V
1600HF~3500HF/2000HFP~3800HFP : 440V

Func-code	Name	Run-time Edit	Description	Defaults
PID Control(Note4)				
A70	PID Function selection	X	Enables PID function and Feed Forward Function, three option codes: 0.... PID control disable 1.... PID control enable 2.... F/F control enable	0
A71	PID Reference	O	Displays the PID reference. If parameter A72 = 2, Used to adjust the PID reference from UP/DOWN key 0.0 to 100.0% in units of 0.01%	0.00%
A72	PID Reference source	X	Four options : select codes: 0.... Keypad potentiometer 1.... Control terminal input 2.... Standard operator 3.... Remote operator(communication)	2
A73	PID Feed-back source	X	Selects source of PID, option codes: 0.... "OI" (current input) 1.... "O" (voltage input)	0
A74	PID P gain	O	Sets the proportional gain that is applied to the deviation between the reference and the feedback signal. 0.1 to 1000% in units of 0.1%	100.0%
A75	PID I gain	O	Set the integral time to output the accumulated PID error value. 0.0 to 3600sec in units of 0.1sec	1.0sec
A76	PID Dgain	O	Sets the output value to the variation of the PID input. 0.00 ~ 10.00sec in units of 0.01sec	0.0sec
A77	PID Err limit	O	Set the maximum/minimumPID input(error) as a percentage of the maximum error. 0.0 ~ 100.0% in units of 0.1%	100.0%
A78	PID Output high limit	O	Set the maximum PID output as a percentage of the maximum output frequency (A04). -100.0 ~ 100.0% in units of 0.1%	100.0%
A79	PID Output low limit	O	Set the minimum PID output as a percentage of the maximum output frequency (A04). When set to 0.00%, the low limit is disabled. -100.0% ~ 100.0% in units of 0.1%	0.0%

Func-code	Name	Run-time Edit	Description	Defaults
A80	PID Output reverse	X	Two options : select codes 0.... PID output reverse disable 1.... PID outputreverse enable	0
A81	PID scale factor	X	PID scale factor (multiplier), 0.1 to 1000% in units of 0.1%	100.0%
A82	Pre PID frequency(Note5)	X	0.0 to Max Frequency(A04) in units of 0.01Hz. When A82 equals "0", Pre-PID function is disabled.	0.00Hz
A83	Sleep frequency(Note6)	X	0.00 to Max Frequency(A04) in units of 0.01Hz	0.00Hz
A84	Sleep delay time(Note6)	X	0.0 to 30.0sec in units of 0.1sec	0.0sec
A85	Wake up frequency(Note6)	X	Sleep frequency(A83) to Max Frequency(A04) in units of 0.01Hz	0.00Hz

Note 4: PID feedback control

The PID(Proportional, Integral, Differential) control functions can apply to controlling of fan, the air (water) amount of pump, etc., as well as controlling of pressure within a fixed value.

[Input method of target value signal and feedback signal]

Set the reference signal according to the PID reference setting method(A72).

Set the feedback signal according to analog voltage input (0 to 10V) or analog current input (4 to 20mA).

To use analog current [OI-L] for the target value, set the [AT] terminal to ON.

[PID gain adjustment]

If the response is not stabilized in a PID control operation, adjust the gains as follows according to the symptom of the inverter.

- The change of controlled variable is slow even when the target value is changed.
→ Increase P gain [A74]
- The change of controlled variable is fast, but not stable.
→ Decrease P gain[A74]
- It is difficult to make the target value match with the controlled variable.
→ Decrease I time [A75]
- Both the target value and the controlled variable are not stable.
→ Increase I time [A75]
- The response is slow even when the P gain is increased.
→ Increase D time [A76]
- The response is not stabilized due to oscillation even when the P gain is increased.
→ Decrease D time [A76]

The figure below is a more detailed diagram of the PID control.

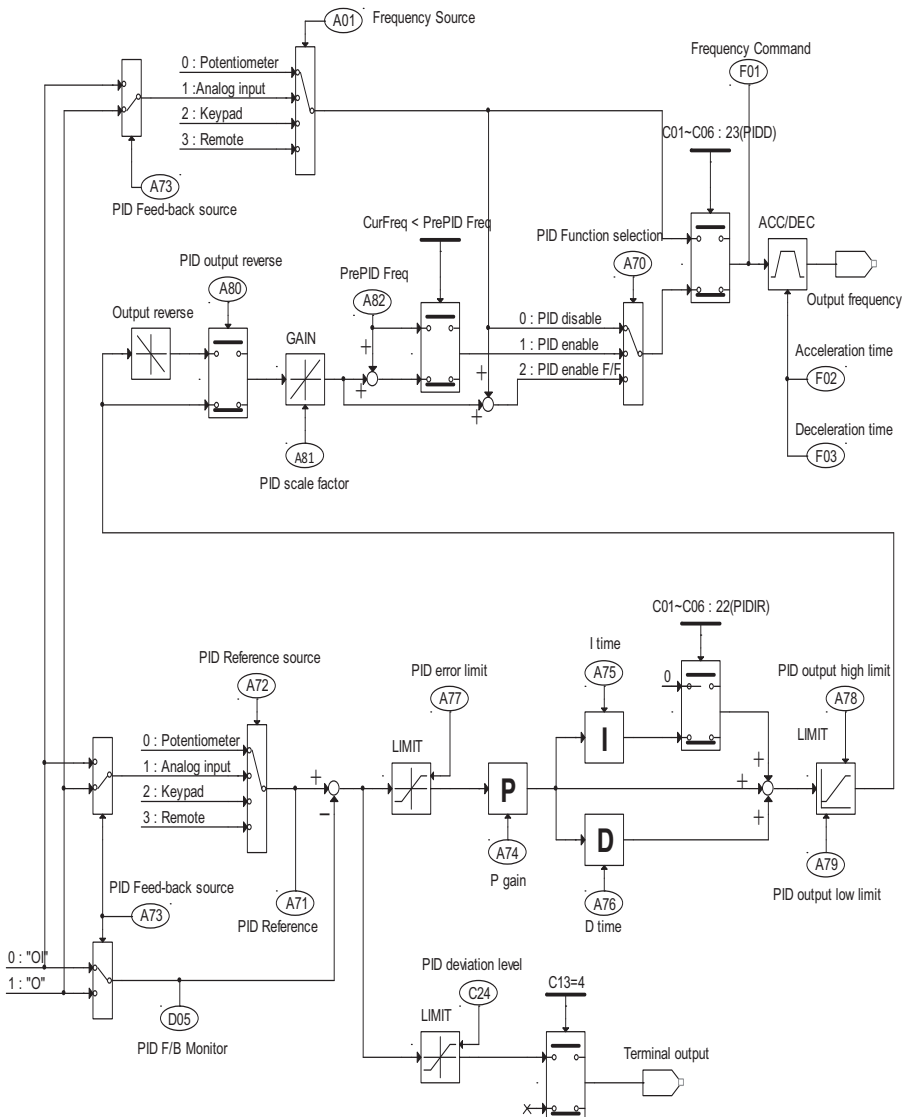
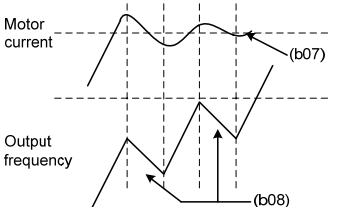

Fig4-1 PID diagram

4.2.5 Expanded function mode of b group

Func-code	Name	Run-time Edit	Description	Defaults
Restart Mode				
b01	Selection of restart mode	X	Select inverter restart method, four option codes: 0.... Alarm output after trip, no automatic restart 1.... Restart at 0Hz 2.... Resume operation after frequency matching 3.... Resume previous freq. after freq. matching, then decelerate to stop and display trip info. •Restart trip is overcurrent, overvoltage and under voltage. •Overcurrent and over voltage trip restart up to 3 times, under voltage trip restart up to 10times.	0
b02	Allowable instantaneous power failure time setting	X	The amount of time a power input undervoltage can occur without tripping the power failure alarm. Range is 0.3 to 1.0sec. If under-voltage exists longer than this time, the inverter trips, even if the restart mode is selected. This function depends on the machine and load conditions. Before using this function, user must perform verification test.	1.0sec
b03	Reclosing standby after instantaneous power failure recovered	X	Time delay after under-voltage condition goes away, before the inverter runs motor again. Range is 0.3 to 10.0 seconds.	1.0sec
Electronic Thermal Overload Alarm Setting				
b04	Electronic thermal level setting	X	Set a level between 20% and 120% for the rated motor current. setting range- 0.2× (motor rated current) ~ 1.2×(motor rated current).	100.0%
b05	Electronic thermal characteristic, selection	X	Select cooling method for motor: 0....Cooling fan is mounted on the motor shaft (Self-cool) 1....Cooling fan is powered by independent source (Forced-cool)	1

Func-code	Name	Run-time Edit	Description	Defaults
Overload Restriction				
b06	Overload overvoltage Restrictionmode selection	X	Select overload or overvoltage restriction modes 0.... Overload, overvoltage restriction mode OFF 1.... Only overload restriction mode ON 2.... Only overvoltage restriction mode ON 3.... Overload /overvoltage restriction mode ON	3
b07	Overload restriction level setting	X	Sets the level for overload restriction, between 20% and 200% of the rated current of the inverter, setting range $0.2x(\text{inverter rated current}) \sim 2.0x(\text{inverter rated current})$	HD : 180% ND : 150% ($\leq 132\text{kW}$) HD : 150% ND : 120% ($\geq 160\text{kW}$)
b08	Overload restriction constant setting	X	Set the deceleration rate when inverter detects overload, range is 0.1 to 10.0 and resolution is 0.1 	1.0sec
Software Lock Mode				
b09	Software lock mode selection	X	Prevents parameter changes, in four options, option codes: 0.... All parameters except b09 are locked when SFT from terminal is on 1.... All parameters except b09 and output frequency F01 are locked when SFT from terminal is ON 2.... All parameters except b09 are locked 3.... All parameters except b09 and output frequency F01 setting are locked	0

Func-code	Name	Run-time Edit	Description	Defaults
Other Function				
b10	Start frequency Adjustment	X	Sets the starting frequency for the inverter output, range is 0.50 to 10.00Hz in units of 0.01Hz	0.50Hz
b11	Carrier frequency setting	O	Sets the PWM carrier frequency, range is Refer to 'Carrier frequency ranges of different types.' ^(Note8)	(Note7)
b12	Initialization mode(parameters or trip history)	X	Select the type of initialization to occur, two option codes: 0.... Trip history clear 1.... Parameter initialization (exceptional data) b13 : Country code A53 : Rated Motor Voltage	0
b13	Country code for initialization	X	Select default parameter values for country on initialization, three options, option codes: 0.... Korea version 1.... Europe version 2.... US version	0
b14	RPM conversion factor setting	O	Specify a constant to scale the displayed RPM for [d08] monitor, range is 0.01 to 99.99 in units of 0.01	1.00
b15	STOP key validity during terminal operation	X	Select whether the STOP key on the keypad is enabled, two option codes: 0.... stop enabled 1.... stop disabled	0
b16	Resume on FRS cancellation mode	X	Select how the inverter resumes operation when the free-run stop (FRS) is cancelled, two options: 0... Restart from 0Hz 1....Restart from frequency detected from real speed of motor	0
b17	Communication number	X	Sets the communication number for communication, range is 1 to 32.	1
b18	Ground fault setting	X	Select the function and level of ground fault.. 0 : Do not detect ground fault. 0.0~100.0% : Detect ground fault as the % level of rated current.	0.0
b19	Speed Search Current Suppression Level	O	Controls the starting current level during speed search motion on the basis of the motor rated current. The Current Suppression Level of the controller is set from 90 % to 180%	100%

Func-code	Name	Run-time Edit	Description	Defaults
Other Function				
b20	Voltage increase Level during Speed Search	<input type="radio"/>	In case of the lower starting current level during speed search motion on the basis of the motor rated current, the increase level of the output voltage is set from 10 % to 300%	100%
b21	Voltage decrease Level during Speed Search	<input type="radio"/>	In case of the higher starting current level during speed search motion on the basis of the motor rated current, the decrease level of the output voltage is set from 10 % to 300%	100%
b22	Speed decrease Level during Speed Search	<input type="radio"/>	Controls the speed decrease level during speed search motion. The speed decrease level of the controller is set from 1.0 to 200.0% (Operator display : 10 ~ 2000)	100.0% (1000)
b23	Frequency match operation selection	<input type="radio"/>	In case of inverter starting operation, the start frequency of the inverter can be selected as follows 0 : 0Hz Starting operation 1 : Frequency matching & start operation	0
b24	Failure status output selection by relay in case of failure	<input type="radio"/>	In case of low voltage failure, the alarm relay operation can be selected as follows 0 : Inactive in case of low voltage failure 1 : Active in case of voltage failure (Inactive in case of restart mode) 2 : Active in case of all failure occurred include LV failure 3 : Active in case of voltage failure (In case of low voltage failure, automatic restart).	0
b25	Stop method selection	<input type="radio"/>	You can choose the method of stopping the motor when the inverter is given a stop command during operation. 0 : a normal decelerating stop 1 : free-run stop	0
b26	Inverter type change to P-type(Normal Duty)	<input type="checkbox"/>	In different types of load, Inverter can be classified into two types which are "Light load type(ND) and "Heavy load type(HD)". "Rated Power" and "Over load tolerance" are different from these two types. In the application for FANs or PUMPs choose "Normal Duty". 0 : Heavy Duty(Standard Type) 1 : Normal Duty(P-Type)	0

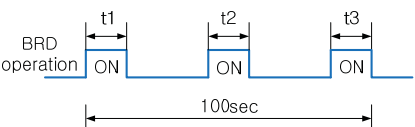
Func-code	Name	Run-time Edit	Description	Defaults
b27	Input phase loss	X	A function that detects phase loss in the input AC source. Detection is performed using the fluctuation in the main circuit's DC voltage. Also, in the case of degradation in the main capacitor, this message could be occurred. To set the detection time of input phase loss, "code b27" is used. (0 ~ 30 in sec) When b27 equals "0", input phase loss function is disabled.	10
Other Function				
b28	Communication time out setting	O	This function detects communication time out in case of communication cut off. To set the detection time of time out, "code b28" is used. 0: No detect time out 0~60 : Detect time out when communication cut off [Unit : second]	0
b29	Communication time out operation mode	O	Set the communication time out operation mode 0 : Always active 1 : Active in case of inverter is running	0
b30	Display code setting	O	Set Initial display code d01 ~d13 after power on. "code b30" is used.(1 ~ 13)	1
b31	2 nd Communication Channel (option) baud rate setting	X	Setting 2 nd 485 communication channel baud rate 1:2400bps 2:4800bps 3:9600bps 4:19200bps	3
BRD(Dynamic braking) Function				
b32	BRD selection	X	Three options: select codes: 0 : Invalid : BRD doesn't operate 1 : During run : valid (BRD operates.) During stop : invalid (BRD doesn't operate.) 2 : During run, stop, valid (BRD operates.)	1
b33	BRD using ratio	X	Sets the BRD using ratio, range is 0.0 to 50.0% in units of 0.1%. When inverter exceeds the usage ratio, a trip occurs. $\text{BRD using ratio (\%)} = \frac{(t1 + t2 + t3)}{100\text{sec}} \times 100$ 	10.0%

Footnotes for the preceding tables

Note7:Carrier frequency factory setting in types of Inverter load and model.

Model	Heavy Duty (b26 = 0)	Normal Duty (b26 = 1)
IMASTER-E1-055LF/075LFP~185LF/220LFP IMASTER-E1- 055HF/075HFP~185HF/220HFP	5.0kHz	2.0kHz
IMASTER-E1-220LF IMASTER-E1- 220HF/300HFP~1320HF/1600HFP	3.0kHz	2.0kHz
IMASTER-E1- 1600HF/2000HFP~3500HF/3800HFP	2.0kHz	2.0kHz

※ By setting up b26=1, All models have the same carrier frequency 2.0kHz.

Note8 : Carrier frequency ranges of different inverter types

Model	Range(kHz)
IMASTER-E1-055LF/075LFP~150LF/185LFP IMASTER-E1-055HF/075HFP~150HF/185HFP	1.0 ~16.0
IMASTER-E1-185LF/220LFP~220LF IMASTER-E1- 185HF/220HFP~1320HF/1600HFP	1.0 ~10.0
IMASTER-E1- 1600HF/2000HFP~3500HF/3800HFP	1.0~4.0

※ If IMASTER-E1-1600HF/2000HFP~3500HF/3800HFP are used more than 2kHz carrier frequency, they must derate as much as 5%/kHz of rated current.

4.2.6 Expanded Function Mode of C Group

Func-code	Name	Run-time Edit	Description	Defaults
Input Terminal Function				
C01	Intelligent Input terminal 1 setting	X	Select function for terminal 1 <code> 0: Forward run command(FW) 1 : Reverse run command(RV) 2 : 1st multi-speed command(CF1) 3 : 2nd multi-speed command(CF2) 4 : 3rd multi-speed command(CF3) 5 : 4th multi-speed command(CF4) 6 : Jogging operation command(JG) 8 : 2-stage acceleration/deceleration command(2CH) 9 : Free-run stop command(FRS) 10 : External trip(EXT) 11 : Unattended start protection(USP) 12 : Software lock function(SFT) 13 : Analog input current/voltage selection signal(AT) 14 : Reset(RS) 15 : Start(STA) 16 : Keep(STP) 17 : Forward/reverse(F/R) 18 : Remote control UP(UP) 19 : Remote control DOWN(DOWN) 20 : Local Keypad Operation(O/R) 21 : Local Terminal Input Operation(T/R) 22 : PID Integral Reset(PIDIR) 23 : PID Disable(PIDD)	0
C02	Intelligent Input terminal 2 setting	X	Select function for terminal 2 <code>-see C01 parameter	1
C03	Intelligent Input terminal 3 setting	X	Select function for terminal 3 <code>-see C01 parameter	2
C04	Intelligent Input terminal 4 setting	X	Select function for terminal 4 <code>-see C01 parameter	3
C05	Intelligent Input terminal 5 setting	X	Select function for terminal 5 <code>-see C01 parameter	13
C06	Intelligent Input terminal 6 setting	X	Select function for terminal 6 <code>-see C01 parameter	14

Func-code	Name	Run-time Edit	Description	Defaults
Input Terminal Status				
C07	Input Terminal 1 a/b contact setting(NO/NC)	X	Select logic convention, two option codes: 0.... normally open [NO] 1.... normally closed [NC]	0
C08	Input Terminal 2 a/b contact setting(NO/NC)	X	Select logic convention, two option codes: 0.... normally open [NO] 1.... normally closed [NC].	0
C09	Input Terminal 3 a/b contact setting(NO/NC)	X	Select logic convention, two option codes: 0.... normally open [NO] 1.... normally closed [NC]	0
C10	Input Terminal 4 a/b contact setting(NO/NC)	X	Select logic convention, two option codes: 0.... normally open [NO] 1.... Normally closed [NC].	0
C11	Input Terminal 5 a/b contact setting(NO/NC)	X	Select logic convention, two option codes: 0.... normally open [NO] 1.... Normally closed [NC].	0
C12	Input Terminal 6 a/b contact setting(NO/NC)	X	Select logic convention, two option codes: 0.... normally open [NO] 1.... Normally closed [NC].	0
Output Terminal and related Function				
C13	Alarm Relay output setting	X	Select function for Alarmrelay output 0... RUN(Run signal) 1.... FA1(Frequency arrival signal: command arrival) 2.... FA2(Frequency arrival signal: setting frequency or more) 3.... OL(Overload advance notice signal) 4.... OD(Output deviation for PID control) 5.... AL(Alarm signal)	5
C14	Intelligentterminal Relay output setting(RN0-RN1)	X	Select function for terminal RN0-RN1 0... RUN(Run signal) 1.... FA1(Frequency arrival signal: command arrival) 2.... FA2(Frequency arrival signal: setting frequency or more) 3.... OL(Overload advance notice signal) 4.... OD(Output deviation for PID control) 5.... AL(Alarm signal)	1
C15	Intelligentterminal Relay output setting(RN2-RN3)	X	Select function for terminal RN2-RN3 0... RUN(Run signal) 1.... FA1(Frequency arrival signal: command arrival) 2.... FA2(Frequency arrival signal: setting frequency or more) 3.... OL(Overload advance notice signal) 4.... OD(Output deviation for PID control) 5.... AL(Alarm signal)	0
C16	Output Terminal RN0-RN1 a/b contact setting	X	Select logic convention, two option codes: 0.... a contact(normally open) [NO] 1.... b contact(normally closed) [NC]	0

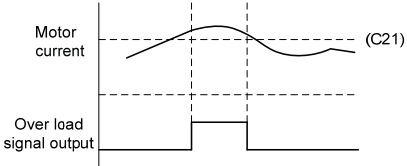
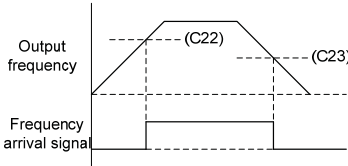
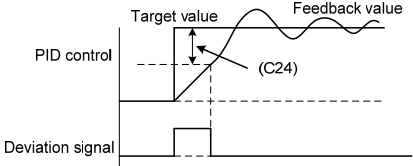
Func-code	Name	Run-time Edit	Description	Defaults
C17	Output Terminal RN2-RN3 a/b contact setting	X	Select logic convention, two option codes: 0.... a contact(normally open) [NO] 1.... b contact(normally closed) [NC]	0
C18	FM output selection	X	Select function for terminal FM, 3 options 0.... output frequency monitor 1.... output current monitor 2.... output voltage monitor 3.... output power monitor	0
C19	FM gain adjustment	O	Range is 0 to 250.0, resolution is 1	100.0%
C20	FM offset adjustment	O	Range is -3.0 to 10.0%resolution is 0.1	0.0%
C21	Overload advance notice signallevel setting	X	Sets the overload signal level between 10% and 200% resolution is 0.1%. $0.1x(\text{Inverter rated current}) \sim 2.0x(\text{Inverter rated current})$ 	100.0%
C22	Acceleration arrival signal frequency setting	X	Sets the frequency arrival setting thres-hold for the output frequency during acceleration. Setting range is 0.00 to maximum frequency(A04), resolution is0.01Hz 	0.00Hz
C23	Deceleration arrival signal frequency setting	X	Sets the frequency arrival setting threshold for the output frequency during deceleration, setting range is 0.00 to maximum frequency(A04) resolution is 0.01Hz	0.00Hz
C24	PID deviation level setting	X	Sets the allowable PID loop error magnitude. Setting range is 0.0 to 100.0%, resolution is 0.01% 	10.0%

Func-code	Name	Run-time Edit	Description	Defaults
C25	AMI output selection	X	Select function for terminal FM, 3 options 0.... output frequency monitor 1.... output current monitor 2.... output voltage monitor 3.... output power monitor	1
C26	AMI gain adjustment	O	Range is 0 to 250.0, resolution is 1	100.0%
C27	AMI offset adjustment	O	Range is -99.9 ~ 100.0%resolution is 0.1	0.0%

4.2.7 Expanded Function mode of H Group

Func-code	Name	Run-time Edit	Description	Defaults
H01	Auto-tuningmode selection	X	Two States for auto-tuning function, option codes: 0... Auto-tuning OFF 1... Auto-tuning ON	0
H02	Motor data selection	X	Two selections, option codes: 0...Use standard motor data 1...Use auto-tuning data	0
H03	Motor capacity	X	2.2L : 220V / 2.2kW 3.7L : 220V / 3.7kW 5.5L : 220V / 5.5kW 7.5L : 220V / 7.5kW 11L : 220V / 11kW 15L : 220V / 15kW 18.5L : 220V / 18.5kW 22L : 220V / 22kW 30L : 220V / 30kW 2.2H : 380V / 2.2kW 3.7H : 380V / 3.7kW 5.5H : 380V / 5.5kW 7.5H : 380V / 7.5kW 11H : 380V / 11kW 15H : 380V / 15kW 18.5H : 380V / 18.5kW 22H : 380V / 22kW 30H : 380V / 30kW 37H : 380V / 37kW 45H : 380V / 45kW 55H : 380V / 55kW 75H : 380V / 75kW 90H : 380V / 90kW 110H : 380V / 110kW 132H : 380V / 132kW 160H : 380V / 160kW 200H : 380V / 200kW* 220H : 380V / 220kW 250H : 380V / 250kW* 280H : 380V / 280kW 320H : 380V / 320kW* 350H : 380V / 350kW 380H : 380V / 375kW	
H04	Motor poles setting	X	2/4/6/8	4
H05	Motor rated current	X	Range is 0.1 – 800.0A	-
H06	Motor no-load current I0	X	Range is 0.1 – 400.0A	-
H07	Motor rated slip	X	Range is 0.01 – 10.0%	-
H08	Motor Resistance R1	X	Range is 0.001 - 30.00Ω	-
H09	Transient Inductance	X	Range is 0.01 – 100.0mH	-
H10	Motor ResistanceR1	X	Range is 0.001 - 30.00Ω	-
H11	Transient Inductance auto tuning data	X	Range is 0.01 – 100.0mH	-

* When B26 is set to 1, this motor series is displayed. (200H,250H,320H)

5. Protective function

The various functions are provided for the protection of the inverter itself, but they may also provide protection function when the inverter breaks down.

Name	Cause(s)	Error Code
Overcurrent protection	When the inverter output current exceeds the rated current by more than approximately 200% during the motor locked or reduced in speed. Protection circuit activates, halting inverter output.	E04
Overload protection (Electronic thermal) Regenerative	When the inverter output current causes the motor to overload, the electronic thermal trip in the inverter cuts off the inverter output.	E05
Over voltage protection	If regenerative energy from the motor or the main power supply voltage is high, the protective circuit activates to cut off the inverter output when the voltage of DC link exceeds the specification	E07
Communication error	Communication error between inverter and its operator. If the Reset signal persists for more than 4 seconds, it will occur.	E60
Under-voltage protection	When input voltage drops below the low-voltage detection level, the control circuit does not function normally. So when the input voltage is below the specification, the inverter output is cut off.	E09
Output short-circuit	The inverter output was short-circuited. This condition causes excessive current for the inverter, so the inverter output is turned off.	E04 or E34
USP error	The USP error is indicated when the power is turned on with the Inverter in RUN state. (Enabled when the USP function is selected)	E13
EEPROM	The inverter output is cut off when EEPROM in the inverter has an error due to external noise, excessive temperature rise, or other factor	E08
External trip	When the external equipment or unit has an error, the inverter receives the corresponding signal and cuts off the output.	E12
Input phase loss	A function that detects phase loss in the input AC source. Detection is performed using the fluctuation in the main circuit's DC voltage. Also, in the case of degradation of main capacitors it could be occurred.	E20
Temperature trip	When the temperature in the main circuit increases due to cooling fan stop, the inverter output is cut off. (only for the model type with cooling fan)	E21
Ground fault	When ground fault is detected on running condition, the output is cut off.	E14
Inverter Overload	The power device IGBT is protected from over heat. The operating time of inverter is 1 minute with 150% load of HD or 120% load of ND. The operating time is changed depending on carrier frequency, load, ambient temperature and power rating.	E17
Braking resistor overload protection	When BRD exceeds the usage ratio of the regenerative braking resistor, the over-voltage circuit activates and the inverter output is switched off.	E06

6. Specification

6.1 Standard specification list

(1) 200V Class Specifications(IP20)

Inverter Model		055LF/ 075LFP	075LF/ 110LFP	110LF/ 150LFP	150LF/ 185LFP	185LF/ 220LFP	220LF	
Max. Applicable motor (4P, kW) ^(Note1)	HD	5.5	7.5	11	15	18.5	22	
	ND	7.5	11	15	18.5	22	-	
Rated capacity (kVA)	HD	200V	8.3	11.1	15.6	22.2	26.3	31.2
		240V	10.0	13.3	18.7	26.6	31.6	37.4
	ND	200V	10.4	15.2	20.0	25.2	29.4	-
		240V	12.5	18.2	24.1	30.3	35.3	-
Rated input voltage		Three-phase 200~240V±10%, 50/60Hz±5%						
Rated output voltage ^(Note2)		Three-phase 200~240V (corresponding to input voltage)						
Rated output current(A)	HD	24	32	45	64	76	90	
	ND	30	44	50	73	85	-	
Weight (Kg)		4.2	4.5	4.5	6.5	7.5	8	
Protection Design		IP20						

(2) 400V Class Specifications

Inverter Model		055HF/ 075HFP	075HF/ 110HFP	110HF/ 150HFP	150HF/ 185HFP	185HF/ 220HFP	220HF/ 300HFP	
Max. Applicable motor (4P, kW) ^(Note1)	HD	5.5	7.5	11	15	18.5	22	
	ND	7.5	11	15	18.5	22	30	
Rated capacity (kVA)	HD	380V	7.9	10.5	15.1	21.1	25.0	29.6
		480V	10.0	13.3	19.1	26.6	31.6	37.4
	ND	380V	10.4	15.2	20.0	25.6	29.7	39.4
		480V	12.5	18.2	24.1	30.7	35.7	47.3
Rated input voltage		Three-phase 380~480V±10%, 50/60Hz±5%						
Rated output voltage ^(Note2)		Three-phase 380~480V (corresponding to input voltage)						
Rated output current (A)	HD	12	16	23	32	38	45	
	ND	15	22	29	37	43	57	
Weight (Kg)		4.2	4.5	4.5	7	7	7.5	
Protection Design		IP20						

Inverter Model		300HF/ 370HFP	370HF/ 450HFP	450HF/ 550HFP	550HF/ 750HFP	750HF/ 900HFP	900HF/ 1100HFP	
Max. Applicable motor (4P, kW) ^(Note1)	HD	30	37	45	55	75	90	
	ND	37	45	55	75	90	110	
Rated capacity (kVA)	HD	380V	38.2	49.4	59.2	72.4	98.1	115.8
		480V	48.2	62.4	74.8	91.5	123.9	146.3
	ND	380V	48.4	58.8	72.7	93.5	111	135
		480V	58.1	70.1	87.2	112	133	162
Rated input voltage		Three-phase 380~480V±10%, 50/60Hz±5%						
Rated output voltage ^(Note2)		Three-phase 380~480V (corresponding to input voltage)						
Rated output current (A)	HD	58	75	90	110	149	176	
	ND	70	85	105	135	160	195	
Weight (Kg)		22	22	27	30	50	50	
Protection Design		IP00						

Inverter Model		1100HF/ 1320HFP	1320HF/ 1600HFP	1600HF/ 2000HFP	2200HF/ 2500HFP	2800HF/ 3200HFP	3500HF/ 3800HFP
Max. Applicable motor (4P, kW) ^(Note1)	HD	110	132	160	220	280	350
	ND	132	160	200	250	320	375
Rated capacity (kVA)	HD	380V	142.8	171.1	195	270	430
		480V	180.4	216.2	230	315	400
	ND	380V	159	204	245	305	390
		480V	191	245	285	360	470
Rated input voltage		Three-phase 380~480V±10%, 50/60Hz±5%					
Rated output voltage ^(Note2)		Three-phase 380~480V (corresponding to input voltage)					
Rated output current (A)	HD	217	260	300	415	525	656
	ND	230	285	370	450	600	680
Weight (Kg)		60	60	110	110	170	170
Protection Design		IP00					

Footnotes for the preceding tables

Note 1. The applicable motor refers to ADT Co., Ltd. standard 3-phase motor(4-pole).

To use other motors, care must be taken to prevent the rated motor current(50/60Hz) from exceeding the rated output current of the inverter.

Note 2. The output voltage decreases as the main supply voltage decreases (except for use of the AVR function). In any case, the output voltage cannot exceed the input power supply voltage.

(3) Common specifications for 200V/400V class

Inverter model		Common specifications for all model	
Control system ^(Note3)		Space vector modulation PWM system	
Output frequency range ^(Note4)		0.01 ~ 400Hz	
Frequency accuracy ^(Note5)		Digital command ±0.01% for Max. frequency, analog frequency ±0.1% (25±10℃)	
Frequency resolving power		Digital setting : 0.01HZ, Analog setting : Max. frequency / 1,000	
Voltage/frequency characteristic		V/f control (constant torque, reduced torque), free V/f control	
Overload current rate		Heavy Duty(150%, 60sec), Normal Duty(120%, 60sec)	
Acceleration/Deceleration		0.1 ~ 3000.0 sec (Director, curve setting)	
DC injection Braking		On starting and decelerating by stop command, inverter operates under operation setting frequency. Or inverter operates with external input (Braking power, time, frequency can be set.)	
Input Signal	Frequency	Operator Extend signal	Setting by up/down key Input voltage : DC0 ~ +10V (Input impedance 10KΩ) Input current : 4 ~ 20mA (Input impedance 200Ω)
	Run/ Stop	Operator Extend signal	Run / Stop key (Forward / Reverse function mode) Forward run / stop (1a connect, 1b selection possibility)
	Intelligent input terminal		FW(Forward), RV(Reverse), CF1~4(Multi-speed bit 1~4), RS(reset), AT(Analog input current/voltage selection signal), USP(USP function) EXT(external trip), FRS(free-run stop), JG(jogging), SFT(software lock), 2CH(2 nd acceleration), STA, STP, F/R(3-wire), UP, DOWN(Up/down), O/R(Local Keypad Operation), T/R(Local Terminal Input Operation), PIDIR(PID Integral Reset), PIDD(PID Disable)

Inverter model		Common specifications for all model
Output Signal	Intelligent output terminal (RN0-RN1,RN2-RN3)	RUN(run status signal), FA1 (frequency arrival signal), FA2 (setting Frequency arrival signal),OL(overload advance notice signal), OD(PID error deviation signal), AL(alarm signal)
	Alarm output terminal	
	FM output	Analog meter (DC0~10V fullscale. Max · 1mA) Output frequency, output current, output voltage and output power
	AMI output	Analog meter (4~20mA full scale. Max · 250Ω) Output frequency, output current, output voltage and output power
Other functions		AVR function, curved accel/decel. profile, upper and lower limiters, 16-stage speed profile, fine adjustment of start frequency, BRD function carrier frequency change(0.5 to 16Khz), frequency jump, gain and bias setting, process jogging, electronic thermal level adjustment, retry function, trip history monitor, auto tuning(1), V/f characteristic selection, Speed Search automatic torque boost, frequency conversion display, USP function
Protection function		Over current, Over load(Electronic thermal), Inverter Over voltage, IOLT Communication error, Under voltage, Output short circuit detection, USP error, EEPROM error, External error, Ground fault, Over heat, Input phase loss, Braking resistor overload
Standard specification	Ambient temperature	-10~40℃ (If ambient temperature is above 40℃, Carrier frequency should be lower than default value.)
	Storage temperature	-20~60℃
	Ambient humidity	Below 90%RH (Installed with no dew condensation)
	Vibration	5.9m/s ² (0.6G). 10~55Hz
	Location	Under 1000m above sea level, indoors (Installed away from corrosive gasses dust)
Option		Noise filter , DC reactor, AC reactor Remote operator, cable for remote operator, Braking resistor ^(Note6)

Footnotes for the preceding table

Note 3 Control method setting A31 to 2 (sensorless vector control) Selected, set carrier frequency(b11) more than 2.1kHz.

Using motor less than half of the rated capacity, you cannot get enough performance.
Multiple motors cannot be driven by sensorless vector control.

Note 4 To operate the motor over 50/60Hz, consult the motor manufacturer about the maximum allowable rotation speed. In case of sensorless control mode, it can be 300Hz

Note 5 Inverter frequency could be exceeded 1.5Hz for the maximum frequency[A04] in the case of motor stabilization is required.

Note 6. The braking torque via capacitive feedback is the average deceleration torque at the shortest deceleration (stopping from 50/60Hz as indicated). It is not continuous regenerative braking torque. And, the average deceleration torque varies with motor loss. This value decreases when operating beyond 50 Hz. If a large regenerative torque is required, the optional regenerative braking resistor should be used.

6.2 The selection of braking resistor and the braking unit

- Resistor values shown in the following table is calculated on the basis of 150% of rated braking torque, 5% ED⁽¹⁾.
- Power rating of resistor should be doubled for resistor frequency 10% ED use. Additional braking unit should be installed for above

Recommended DB Resistors for the Rated Inverter Capacity (5% ED⁽¹⁾)

Inverter capacity	Ohm [Ω]	Wattage [W] ⁽²⁾
055LF/075LFP	17	1000
075LF/110LFP	17	1000
110LF/150LFP	17	1000
150LF/185LFP	8.7	2500
185LF/220LFP	6	3000
220LF	6	4000
055HF/075HFP	70	1200
075HF/110HFP	50	1200
110HF/150HFP	50	2000
150HF/185HFP	30	2500
185HF/220HFP	20	3000
220HF/300HFP	20	4000

(1)ED is based on 100 seconds.

(2)Rated capacity is based on the self-cooling.

6.3 Dimension

(1) IMASTER-E1-055LF/075LFP, IMASTER-E1-075LF/110LFP, IMASTER-E1-110LF/150LFP, IMASTER-E1-055HF/075HFP, IMASTER-E1-075HF/110HFP and IMASTER-E1-110HF/150HFP model external dimension.(mm)

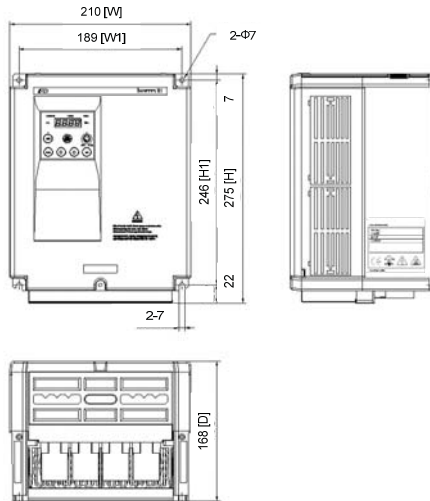

(2) IMASTER-E1-150LF/185LFP, IMASTER-E1-185LF/220LFP, IMASTER-E1-220LF, IMASTER-E1-150HF/185HFP, IMASTER-E1-185HF/220HFP, IMASTER-E1-220HF/300HFP model external dimension.(mm)

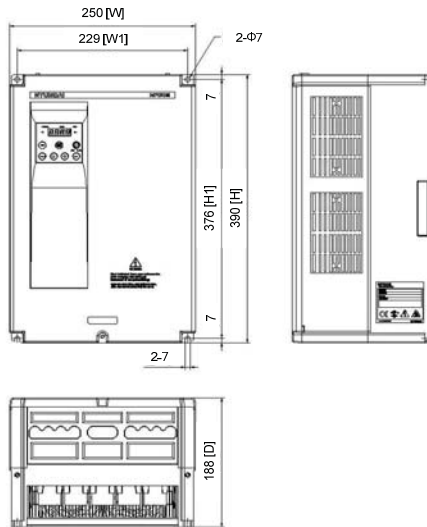

(3) IMASTER-E1-300HF/370HFP, IMASTER-E1-370HF/450HFP model external dimension.(mm)

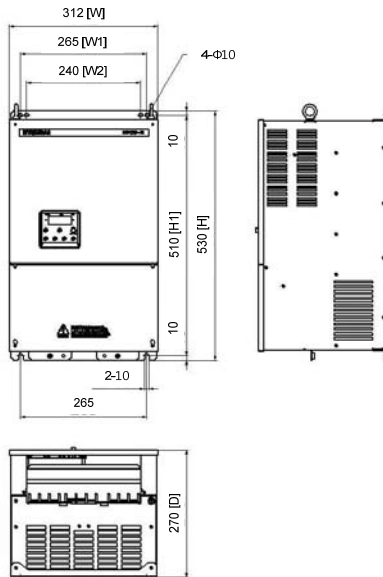

(4) IMASTER-E1-450HF/550HFP, IMASTER-E1-550HF/750HFP model external dimension.(mm)

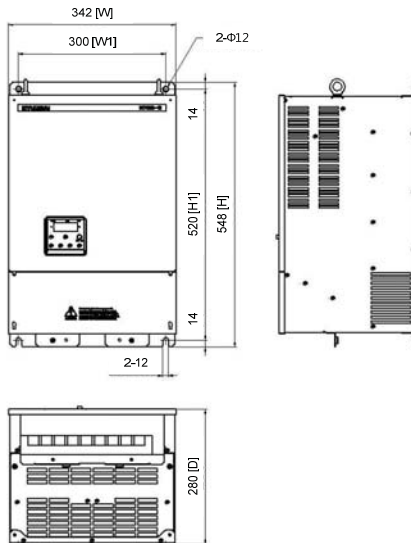

(5) IMASTER-E1-750HF/900HFP, IMASTER-E1-900HF/1100HFP model external dimension.(mm)

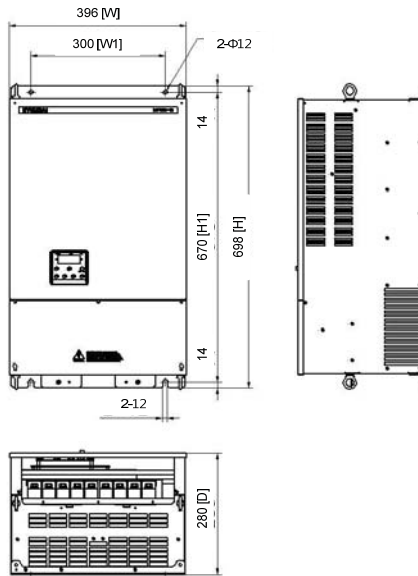

(6) IMASTER-E1-1100HF/1320HFP, IMASTER-E1-1320HF/1600HFP model external dimension.(mm)

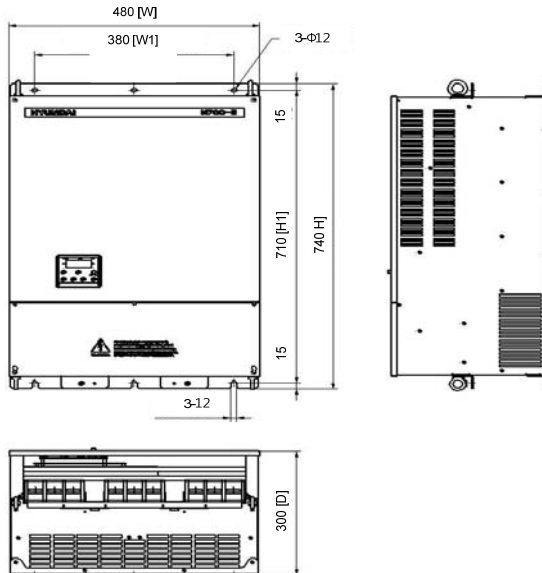

(7) IMASTER-E1-1600HF/2000HFP,
dimension.(mm)

IMASTER-E1-2200HF/2500HFPmodel

external

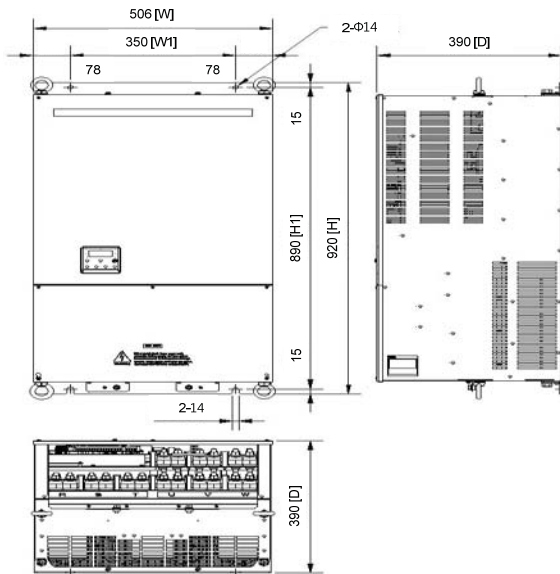

(8) IMASTER-E1-2800HF/3200HFP,
dimension.(mm)

IMASTER-E1-3500HF/3800HFPmodel

external

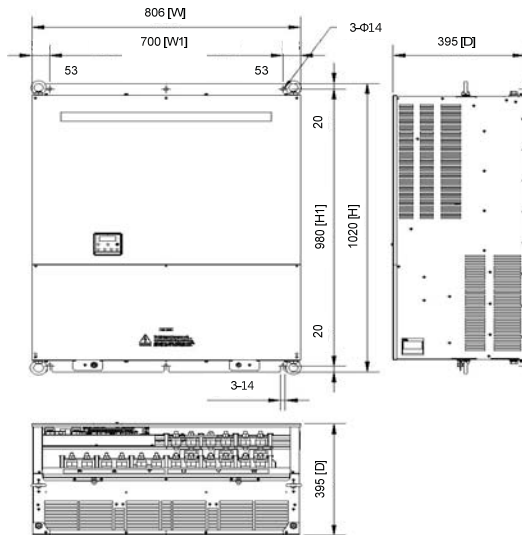

Model	W(Width) [mm]	W1 [mm]	W2 [mm]	H(Height) [mm]	H1 [mm]	D(depth) [mm]	∅ [mm]	Weight [kg]
IMASTER-E1-055LF/075LFP	210	189	-	275	246	168	7	4.2
IMASTER-E1-075LF/110LFP	210	189	-	275	246	168	7	4.5
IMASTER-E1-110LF/150LF	210	189	-	275	246	168	7	4.5
IMASTER-E1-150LF/185LF	250	229	-	390	376	188	7	6.5
IMASTER-E1-185LF/220LF	250	229	-	390	376	188	7	7.5
IMASTER-E1-220LF	250	229	-	390	376	188	7	8
IMASTER-E1-055HF/075HFP	210	189	-	275	246	168	7	4.2
IMASTER-E1-075HF/110HFP	210	189	-	275	246	168	7	4.5
IMASTER-E1-110HF/150HFP	210	189	-	275	246	168	7	4.5
IMASTER-E1-150HF/185HFP	250	229	-	390	376	188	7	7
IMASTER-E1-185HF/220HFP	250	229	-	390	376	188	7	7
IMASTER-E1-220HF/300HFP	250	229	-	390	376	188	7	7.5
IMASTER-E1-300HF/300HFP	312	265	240	530	510	270	10	22
IMASTER-E1-370HF/450HFP	312	265	240	530	510	270	10	22
IMASTER-E1-450HF/550HFP	342	300	-	548	520	280	12	27
IMASTER-E1-550HF/750HFP	342	300	-	548	520	280	12	30
IMASTER-E1-750HF/900HFP	396	300	-	698	670	280	12	50
IMASTER-E1-900HF/1100HFP	396	300	-	698	670	280	12	50
IMASTER-E1-1100HF/1320HFP	480	380	-	740	710	300	12	60
IMASTER-E1-1320HF/1600HFP	480	380	-	740	710	300	12	60
IMASTER-E1-1600HF/2000HFP	506	350	-	920	890	390	14	110
IMASTER-E1-2200HF/2500HFP	506	350	-	920	890	390	14	110
IMASTER-E1-2800HF/3200HFP	806	700	-	1020	980	395	14	170
IMASTER-E1-3500HF/3800HFP	806	700	-	1020	980	395	14	170

