

DH-H4A

4MP Indoor Fixed-focal Wi-Fi Pan & Tilt Network Camera



- 4-MP 1/3" CMOS image sensor, low luminance, and high definition image.
- Outputs max. 4 MP (2560 × 1440)@25 fps.
- H.265 codec, high compression rate, ultra-low bit rate.
- Built-in IR LED, and the max. IR illumination distance is 10 m.
- Supports max. 256 G Micro SD card; built-in Mic; built-in speaker.
- 5 VDC power supply.
- Supports Wi-Fi.
- Supports motion detection, human detection.



Series Overview

Dahua Wireless series cameras are not only easy to install and operate, but also perform outstandingly and cost-effective. They provide full coverage of a scene with 4MP resolution, 0° to 355° pan and -5° to 80° tilt. Their powerful functions, such as human detection and auto tracking, assist with the accurate detection and continuous tracking of targets. Information is also synchronously sent to your phone to keep you up-to-date. These cameras are widely used in small and medium-sized scenes such as small-sized retail stores.

Functions

Motion Detection

When moving objects appear in the monitoring image, Dahua Motion Detection technology triggers alarm or records.

Day/Night

Dahua Day/Night function provides color image when illumination is adequate; when illuminance is inadequate, it switches night mode and provides white and black image. It can guarantee that the network camera can work normally when illuminance changes.

Two-way Talk

With its built-in high-sensitivity microphone and high-power speaker, the camera realizes two-way talk through the mobile app.

Auto Tracking

When a target is detected, the system immediately uses pan and tilt to automatically track the target while they are moving, keeping them within the visual range.

Technical Specification

Camera

Image Sensor	1/3" CMOS
Max. Resolution	2560 (H) × 1440 (V)
Electronic Shutter Speed	Auto/Manual 1/3 s–1/100,000 s
Illumination Distance	Up to 10 m (32.81 ft) (IR)
Illuminator On/Off Control	Auto
Illuminator Number	1 (IR LED)
Angle Adjustment	Pan: 0° to 355°; Tilt: -5° to +80°

Lens

Max. Aperture	3.6 mm: F2.0
Field of View	3.6 mm: H: 74°; V: 41°; D: 88°

Video

Video Compression	H.265
Video Frame Rate	Main stream: 2560 × 1440 @25 fps Sub stream: 640 × 480 @25 fps
Resolution	4M (2560 × 1440); VGA (640 × 480)
Video Bit Rate	H.265: 80 kbps–4096 kbps
Day/Night	Auto(ICR)/Color/B/W
WDR	DWDR
Motion Detection	OFF/ON (4 areas, rectangular)
Image Rotation	0°/180°

Audio

Built-in MIC	Yes, built-in Mic
Built-in Speaker	Yes, built-in speaker
Audio Compression	G.711a

Network

Network Port	RJ-45 (10/100 Base-T)
Wi-Fi	IEEE 802.11b/g/n 2.4–2.4835 GHz, 2.4 G
Storage	Micro SD card (up to 256 GB)
Management Software	DMSS
Mobile Client	iOS;Android

Certification

Certifications	CE
----------------	----

Power

Power Supply	5 VDC, 1A
Power Consumption	Basic: 1.8 W; Max. (video stream acquiring + IR + PTZ Rotation): 3.6 W

Environment

Operating Temperature	-10 °C to +45 °C (+14 °F to +113 °F)
Operating Humidity	≤ 95%

Structure

Casing Material	Plastic
Product Dimensions	φ77.8 mm × 108.1 mm (φ3.06" × 4.26")
Net Weight	204.2 g (0.45 lb)

Ordering Information

Type	Model	Description
4MP Camera	DH-IPC-H4AP-0360B	4MP Indoor Fixed-focal Wi-Fi Pan & Tilt Network Camera
	IPC-H4AP-0360B	4MP Indoor Fixed-focal Wi-Fi Pan & Tilt Network Camera
Accessories	A806A-050100U-EU1	5 VDC 1 A Power Adapter
	TF-C100	MicroSD Memory Card

Accessories

Included:



A806A-050100U-EU1
5 VDC 1 A Power Adapter

Optional:



TF-C100
MicroSD Memory Card

Dimensions (mm[inch])

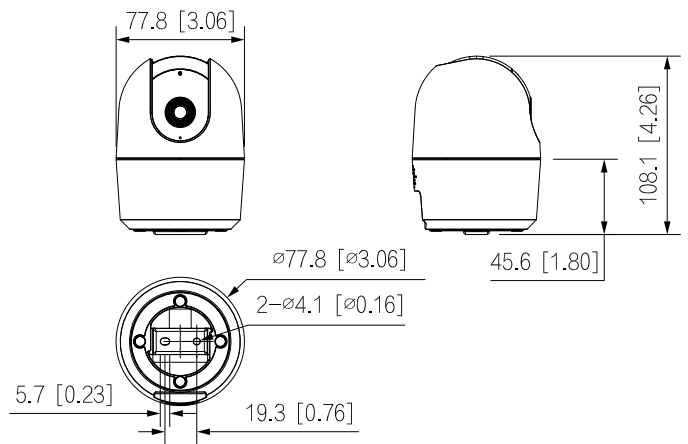

Ceiling Mount	Wall Mount	Table Mount