

AUTOMATIC SOAP DISPENSER

Operation Instruction

Thank you for choosing our automatic soap dispenser Please read carefully before attempting to install, operate or service the product. Protect yourself and others by observing all safety information. Retain instructions for future reference.

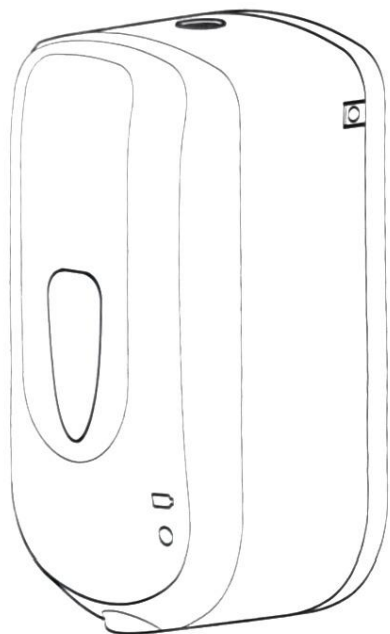

PRODUCT FEATURES

- When working, the work indicator lights up and shows green. When the low power, the low power indicator flashes red, it is recommended to replace the battery
- Built-in smart motion infrared sensor provides you a hands free no-touch experience to keep your family away from bacteria, more hygienic, more healthy, more safety.
- Independent inner tank is easy to refill and no overflow when refilling with wide opening and clear chamber, large capacity can be filled once for about 1000 times.
- Transparent window can be used to see the internal liquid usage and keep abreast of the amount of liquid remaining.
- With dual power supply design, batteries or DC power supply can be used (battery is not included), to ensure low energy consumption and environmental protection.
- Suitable for commercial places such as hotels, offices, hospitals, schools, restaurants, and other public places, helping to reduce the spread of bacteria and improve public hand hygiene.

TECHNICAL SPECIFICATIONS

Rated Voltage:DC4 x 1.5V Capacity:1000ML
 Sensor Distance:3-10cm Spray Volume:1ML/times
 Product Dimensions: 145*110*252mm

NAME OF COMPONENTS

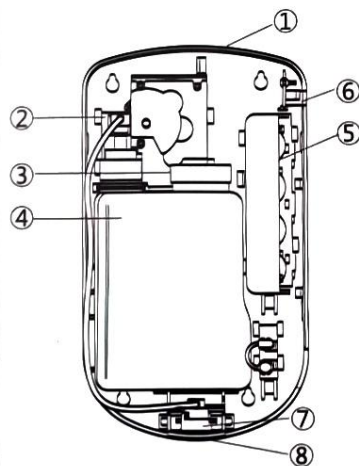

1. Key-hole
2. Pump
3. Lid
4. Cartridge
5. Battery Chamber
6. AC/DC Adaptor connector
7. Sensor area
8. Nozzle

PACKING LIST

Main Unit x 1 Operation Instruction x 1
 AC/DC Adaptor x 1 Spray/Foam Nozzle x 1 Key x 1
 Install Screw x 4 Plastic Anchor x 4

INSTALLATION

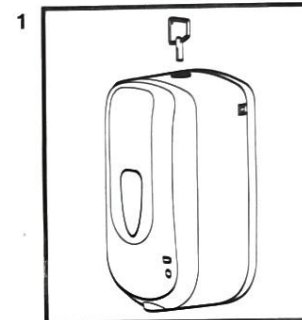

1 Use provide key to open the front cover. Insert the key into the holes located at the top of the dispenser, twisting the key, and pulling the cover towards you. The cover is hinged at the bottom of the dispenser.

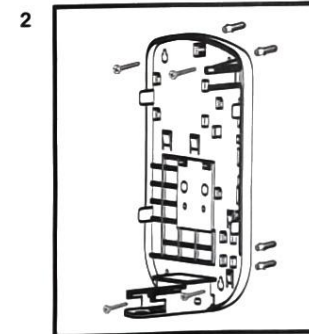

2 Using backplate as template. Mark the location for 4 mounting anchors. Drill holes and insert anchors into holes, screw fasteners halfway into anchors. Mount dispenser onto fasteners. Tighten fasteners (Do not over tighten).

INSTALLATION CONTINUED

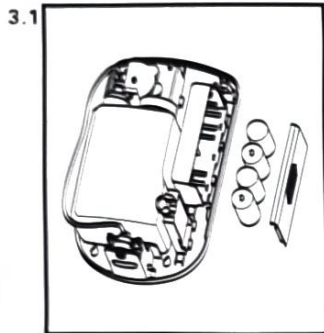

Battery Version

Open dispenser, slide cover forward and place batteries (not included) in the proper orientation then slide cover back into place. Do not mix old and new batteries.



DC Power Supply Version

Open dispenser, plug DC connector into interface (E) and connected to a power source (No need for additional battery).

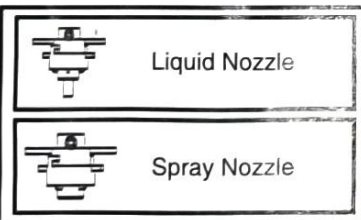
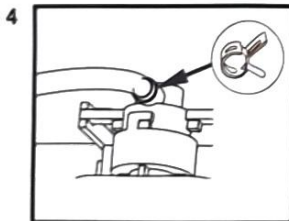

Loose clamp and replace the nozzle. Clip the clamp back to the original position. Make sure that the nozzle of the pump is fixed into the groove.

INSTALLATION CONTINUED

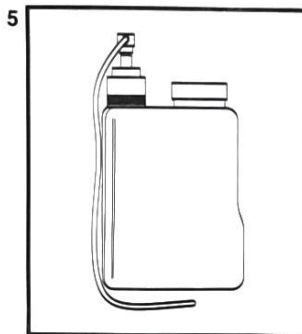

Remove cartridge from dispenser. Remove lid from cartridge. Fill with liquid soap/alcohol and replace cover. Put cartridge back into dispenser. Priming the dispenser will take six to ten pumps.

6. Close dispenser cover and dispenser is now ready to use.

DISPENSER USE



To active dispenser, place hand under bottom of dispenser.

If a second dose is needed, remove hand, and then replace hand under dispenser (when an object comes with 4 inches of the sensing window the dispenser will activate)

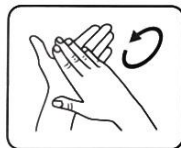

Rub hands palm to palm.

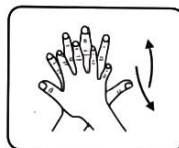

Right palm over left hand with interlaced fingers and vice versa.



Palm to palm with interlaced fingers.

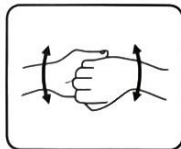

Backs of fingers to opposing palms with fingers interlocked.

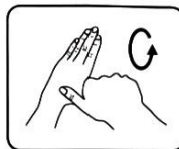

Rotational rubbing of left thumb clasped in right palm and vice versa.



Rotational rubbing with clasped fingers of right hand in left palm and vice versa.

GENERAL SAFETY INFORMATION

- This appliance is not intended for use by persons (including children) with reduced physical, sensory or mental capabilities, or lack of experience and knowledge, unless they have been given supervision or instruction concerning use of the appliance by a person responsible for their safety.
- Ensure a clear space of at least 13 inches above the counter-top, sink or other surface.
- Do not use in areas with high humidity and dustiness.
- Never immerse the product in any water or other liquids
- Never Spray water or cleaning fluids directly on dispenser.
- Never insert foreign objects into the nozzle.

CLEANING AND MAINTENANCE

- Use only fresh new liquid or foam soap and clean the cartridge properly before each re-fill.
- Clean exterior surfaces of the dispenser using warm water and mild soap.
- Never use any abrasive cleaners since they will scratch the finish of the unit.
- While cleaning the unit, make sure the power supply is disconnected.
- Please remove batteries and clean the cartridge if not use the dispenser in a long time

TROUBLESHOOTING

No Dispense, Motor Does Not Run

Hands are not directly beneath sensor
No refill is loaded
Incorrect refill is loaded
Batteries are not loaded, or are loaded incorrectly

No Dispense, Motor Runs

Refill is empty or is loaded improperly
Refill pump is not primed

GUARANTEE

- This product is guaranteed against defects in material and workmanship for a period of one year from the date of original purchase.
- If this dispenser become defective during the guarantee period, return it to the store of purchase together with your proof of purchase for repair or replacement.
- The guarantee become invalid in the case of misuse, alteration or repair by unauthorized persons.