



# Himel Variable Speed Drives

SMART Pump





# About Himel

Himel is a multinational manufacturer and provider of electrical products successfully combining global expertise with local knowledge.

Founded by a Spanish entrepreneur in 1958, the company pioneered in exporting quality electrical enclosures, establishing Himel brand globally. Today, our global footprint and technology enable us to provide the best combination of affordable and reliable offers for Low Voltage Power distribution, Industry Automation and Home Electric to our long-term customers and partners in over 50 countries where we are present.

**Himel. Reliable made affordable**



# SMART Pump (SP)

SMART Pump (SP) drives are full-featured dedicated drives for parabolic load applications like pumps, fans, and chillers. SP drives have a wide range of integrated features like multi-pump control, dry run protection, sensor-less flow and energy calculation, pump cleaning, fire override mode, frost, condensation and hammer effect protections to meet the needs of pump, fans and chillers for modern buildings.

Motor Capacity (kW)																	
2.2	3	4	5.5	7.5	11	15	19	22	30	37	45	55	75	90	110	132	160
HAV-SP-4T*																	
HAV-SP-2T**																	

\*4T: 380V 3 phase

\*\*2T: 220V 3 phase

## Improved Energy Savings

With many integrated control modes like ECO-mode,  $V^2/f$ , and PID with sleep mode.

## High Robustness

- Stable operation in difficult environments
- Built-in category C3 EMC filter ( $\geq 11kW$ )

## Special program functions





- Multi-pump control
- Energy meter
- Flow calculation
- Pump cleaning
- Fire Override mode
- Dual Ramp

## Pump-specific protections

- Dry run detection
- Frost and condensation protection
- Hammer effect protection
- Undervoltage, overvoltage, overcurrent, overload protection
- Phase-loss protection
- Short-circuit protection

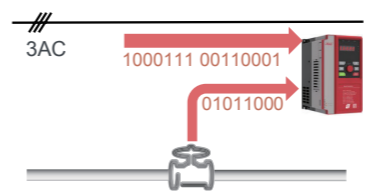

# Reliable made affordable

Features	Your benefits
<b>Improved energy savings</b>	
 <ul style="list-style-type: none"> <li>◆ Integrated Eco-mode for <math>V/f</math> and <math>V^2/f</math> automatically adapts the motor magnetic flux to save energy</li> <li>◆ Improved special PID control with sleep mode helps to save more energy for pump application</li> </ul>	<ul style="list-style-type: none"> <li>◆ Energy savings during low dynamic load cycles such as pump and Fan</li> <li>◆ Increase the potential savings by up to 70%</li> <li>◆ Greatly reduces the return time of investment</li> </ul>
<b>High Robustness</b>	
 <ul style="list-style-type: none"> <li>◆ Stable operation under main input voltage fluctuations. Reliable operation with net tensions between 380V and 480V (-15%/+10 %)</li> <li>◆ Equipped with built-in category C3 standard EMC filter (<math>\geq 11kW</math>)</li> </ul>	<ul style="list-style-type: none"> <li>◆ Wider voltage range, increases robustness of the drive in difficult environment</li> <li>◆ Automatic adaptation in case of unstable power supply</li> <li>◆ Better electromagnetic immunity against signal noises.</li> <li>◆ Supports longer connection cables.</li> </ul>
<b>Special pump functions</b>	
 <ul style="list-style-type: none"> <li>◆ Multi-pump control</li> <li>◆ Built-in energy and flow meter</li> <li>◆ Pump cleaning</li> <li>◆ Fire Override mode</li> <li>◆ Dual Ramp</li> </ul>	<ul style="list-style-type: none"> <li>◆ Control 4 pumps (with external I/O card)</li> <li>◆ Measure energy and flow without an external sensor</li> <li>◆ Pump cleaning</li> <li>◆ Clears the blockage in the pump</li> <li>◆ Reduces the maintenance requirements</li> <li>◆ Keeps the critical fans and pumps running in case of fire in a building</li> <li>◆ Separate initial and final ramp ratio optimizes the motor start and stop</li> </ul>
<b>Pump-specific protections</b>	
 <ul style="list-style-type: none"> <li>◆ Dry run detection</li> <li>◆ Frost and condensation protection</li> <li>◆ Hammer effect protection.</li> <li>◆ Overvoltage, overcurrent, overload protection</li> <li>◆ Phase-loss protection</li> <li>◆ Short-circuit protection</li> </ul>	<ul style="list-style-type: none"> <li>◆ Protects the impeller and rear housing against dry run.</li> <li>◆ Protects the pump against moisture and water freezing inside pump.</li> <li>◆ Controls the water flow when pipe is empty hence eliminating the hammer effect at the starting phase.</li> <li>◆ Long lifecycle running in high humidity and high dust occasions</li> <li>◆ Easy to maintain</li> </ul>



# SPECIAL FEATURES AND BENEFITS



## PID with Sleep mode

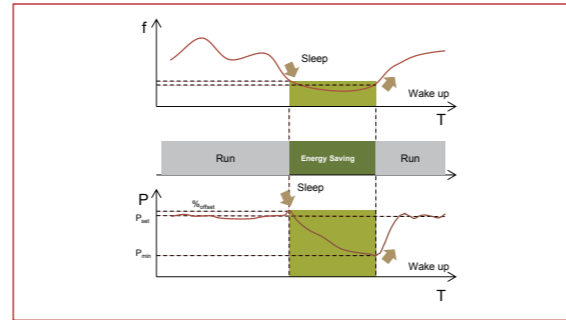

- ◆ Frequent start/stop of the pump wastes energy and causes wear and tear in the pump.
- ◆ PID with sleep mode switches the pump to sleep mode if the pressure increases by a fixed value above the set point.
- ◆ It will wake up the pump if the pressure inside the pipe falls below the lowest required pressure set by the user.
- ◆ PID with sleep mode helps save more energy and enhances pump life

## Pump-cleaning function

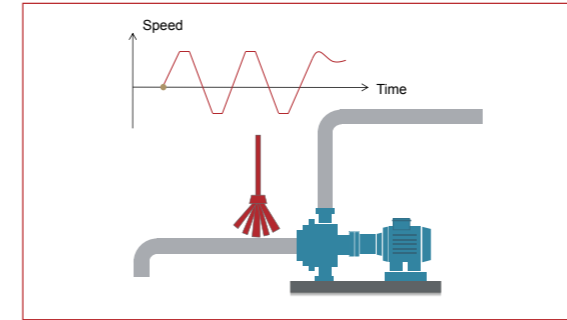

- ◆ In the sewage water processing, the blockage in the pump will reduce the efficiency of the system and make the starting phase very difficult.
- ◆ With pump-cleaning function, the blockage can be swept automatically before the normal operation.
- ◆ It reduces the maintenance requirements

## Special Pump Protections

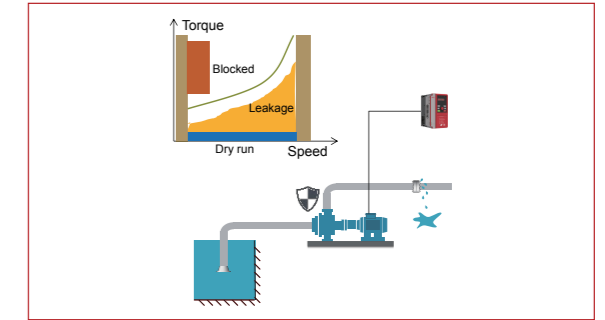

- ◆ The drive can track the load and protect against
  - Dry pump run.
  - Leakage or pipe breakage
  - Blockage in the pipe.
- ◆ Protect the pump against abnormal loads.
- ◆ Protect impeller and rear housing against dry run.
- ◆ Extends pumps life.

## Multi-pump Control (Fixed)

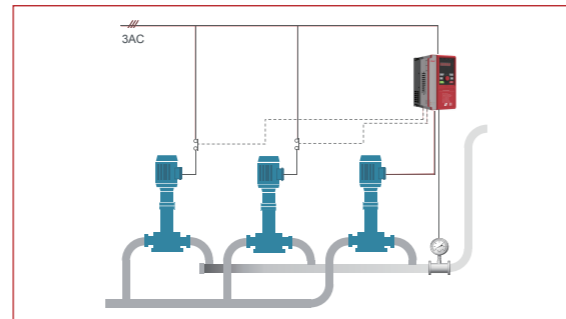

- ◆ Control up to 3 pumps (4 pumps with I/O card) for start, stop and switchover by integrated PID controller.
- ◆ Fixed Type: Motor connected to the drive's output is fixed. VSD increases/decreases the number of motors run by the power grid depending on PID feedback.
- ◆ Floating Type: Motor connected to the drive is not fixed. Drive switches to the next motor and hands over the previous pump to the power grid.
- ◆ Smooth start and stop of each pump to ensure best performance
- ◆ Reduces the total cost of ownership

## Fire Override mode

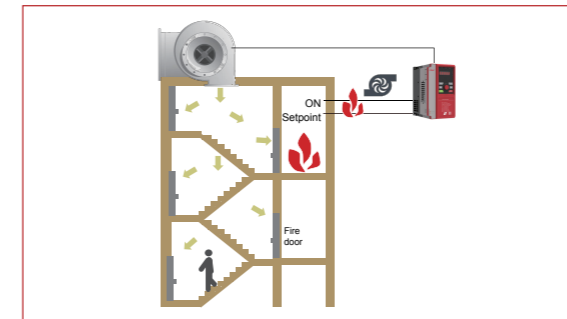

- ◆ The control system or wiring may be damaged in the fire disaster situation, which may disconnect the setpoint or run command of the critical fans in the stair well, tunnel, subway such important space.
- ◆ Fire override mode will keep the fans working without controller in critical situations and help maintain the air-supply and keep fireproof door closed.
- ◆ It keeps fans working to give the pressure in the stair well to force the fireproof door close to reduce the spread of fire and smoke

## Frost and Condensation Protection

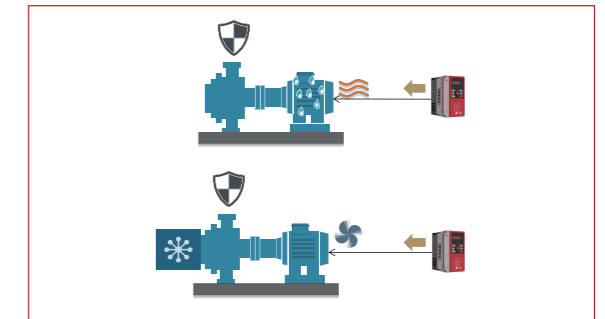

- ◆ Water frozen inside pump damages the pump. Frost protection keeps the motor slowly moving to avoid water freezing inside pump.
- ◆ In humid and cold environments, condensation can cause motor failure. Condensation protection keeps motor warm to get rid of moisture.

## Energy and flow calculator

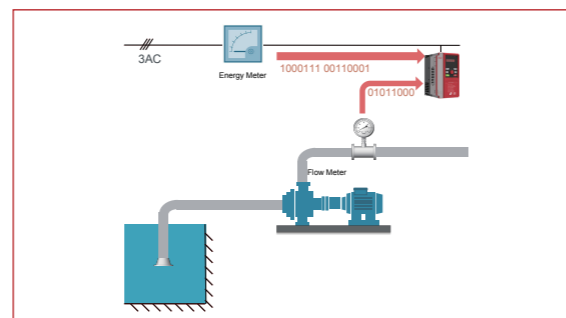

- ◆ Data will be more and more important for the energy audit to continuously improve the system performance.
- ◆ The water volume or flow data will indicate the real-time status. With the Energy and Flow meter, SMART Pump will estimate the energy consumption to explain the status of running pump or fan system to optimize the system

## Dual Ramp

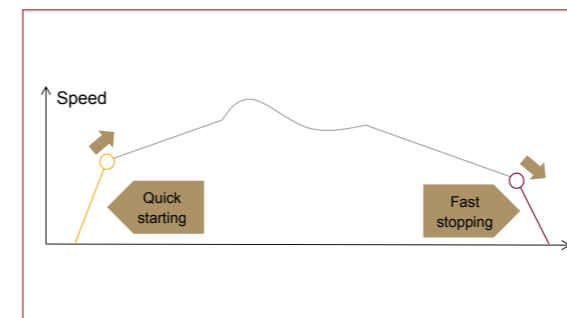

- ◆ Separate initial and final ramp ratio optimizes the motor start and stop. During start phase, pumps (esp. submersible pumps) are more prone to wear and tear if the ramp up is slow. A quick ramp up at start phase protects the pump from wear and tear.
- ◆ Slow ramp up after the initial phase improves the control accuracy.

## Hammer Effect protection

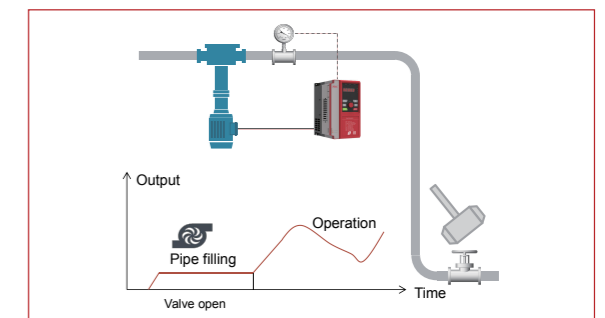

- ◆ In pumping applications, during start phase high speed inrush water can hit the pump very hard which is know as "hammer effect"
- ◆ Smart Pump drive can fill the pipe smoothly at the start phase to avoid pump damage.

## Target Applications



■ Irrigation



■ Sewage



■ Fountain



■ Sand pump



■ Circulating pump



■ Rod pump



■ Drying



■ Ventilation



■ Dust removal



■ Hot surface treatment



■ Air supply fan for boiler



■ Industrial fan



■ Centrifugal chillers



■ Reciprocating chillers



■ Scroll chillers



## Specifications

Range Name		SMART Pump
Design		
Capacity range	Three phase 200V Class	AC: 200V(-15%)-240V(+10%) 2.2~45kW
	Three phase 400V Class	AC:380V(-15%)~440V(+10%) 2.2~160kW
Frequency	Input frequency	50/60Hz
	Output frequency	0-599Hz
Overload capacity		120% for 1min
Control method	V/f	√
	Sensorless vector control	√
	Eco mode control	√
Start torque		0.5Hz, 120%
Built-in PID		√
Keypad		Pluggable
Display		LED/LCD
Multispeed control		16 stages in one cycle
I/O	DI1-DI4	NPN/PNP, Input: 9-30VDC
	DI5	NPN/PNP, Input: 15-30VDC
	DO1	Pulse input: max. 50kHz
	DO2	9-30VDC, max. 50mA
		9-30VDC, max.50mA
		Pulse output max.50kHz
		V: 0-10V
		I:0-20mA
	AI1	Resolution:1/1000
	AI2	V: 0-10V
	AO1	I:0-20mA
	AO2	Resolution:1/1000
		NO: 24VDC 3A/ 250VAC 5A
		NC: 24VDC 3A/ 250VAC 3A
	RO(Ta, Tb, Tc)	
Built-in communication (Max. speed)		RS485, Modbus RTU (38.4kbps)
Options	Extension I/O	DI/DO/RO
	Extension Keypad	Support, cable length:2m, 5m
Functionality		Multi-pump control
		Dry run protection
		Energy/ flow calculator
		Frost and condensation protection
		Pump cleaning
		Fire override mode
	Eco-mode/PID with sleep mode/Special pump protections	
Installation Way		Wall mounted, cabinet, flange installation
Dust Shields		√
EMC Filter	C2	—
	C3	Built-in EMC filter (>=11kW)
Braking unit		Built-in (<=22kW)
Environment	Operation temperature	-10-40 C no capacity reduction, 40 C -50 C capacity reduction
	Humidity	≤95%RH
	Altitude	≤1000m, no capacity reduction
	IP level	IP20
Global certificates		CE



## Specifications

Range Name		SMART Pump
Design		
Features	Velocity ratio	1:100
	Frequency precision	Digital setting: Max frequency X ±0.01%
		Analog setting: Max frequency X ±0.2%
	Frequency resolution	Digital setting: Max frequency X ±0.01%
		Analog setting: Max frequency X ±0.1%
	Torque rise	Integrated auto-torque raising function; with manual- setting: 0.1%~30.0%
	V/F control curve definition	Linear, Square, V <sup>1.7</sup> /F, V <sup>1.2</sup> /F
	Acceleration/Deceleration Time	4 types of ACC/DEC time selection; optional time unit selection(Min/s); setting range: 0~60hours;
	DC braking	Start frequency: 0.00~60.00Hz; braking time: 0.0~30.0S;
		braking current: 0.0~100%
	Automatic voltage regulation(AVR)	√
	Auto current limitation	√
	Auto PMW adjustment	√
Protections	Special pump protection	Voltage limit, dry run, pump load monitor, frost and condensation protections
	VSD protection function	Over-current, over-voltage, under-voltage, over-heat, over-load, short circuit.
	Cooling	Air-cooling
Warranty		24 months

## Reference Selection

Range Name	Series Name	Input	Adaptation	Drive
<b>HAV</b>	<b>SP</b>	<b>4T</b>	<b>0110</b>	<b>P</b>
HA: Himel Automation	S:SMART	2: 220V 4: 380V – 440V	0022: 2.2kW 0075: 7.5kW 0110: 11kW 0185: 18.5kW 1100: 110kW .....	P: Normal-duty
V: VSD M: Motion H: HMI P: PLC	P: Pump	T: Three-phase		

## References

Input Voltage	Commercial Reference	Selection			Overload Output Current	
		Motor Power (kW)	Motor Power (HP)	Continuous Output Current (A)	A	%
AC: 200 - 240V Three Phase	HAVSP2T0022P	2.2	3	10.08	12.1	120%
	HAVSP2T0030P	3	4	11.5	13.8	120%
	HAVSP2T0040P	4	5	16.2	19.4	120%
	HAVSP2T0055P	5.5	7.5	20.3	24.4	120%
	HAVSP2T0075P	7.5	10	26.7	32	120%
	HAVSP2T0110P	11	15	39	46.8	120%
	HAVSP2T0150P	15	20	52.5	63	120%
	HAVSP2T0185P	18.5	25	62.4	74.9	120%
	HAVSP2T0220P	22	30	73.6	88.3	120%
	HAVSP2T0300P	30	40	98.7	118.4	120%
	HAVSP2T0370P	37	50	121	145.2	120%
	HAVSP2T0450P	45	60	147	176.4	120%
	AC: 380 - 440V Three Phase	HAVSP4T0022P	2.2	3	5	6
HAVSP4T0030P		3	4	7.5	9	120%
HAVSP4T0040P		4	5	8.8	10.6	120%
HAVSP4T0055P		5.5	7.5	13	15.6	120%
HAVSP4T0075P		7.5	10	17	20.4	120%
HAVSP4T0110P		11	15	25	30	120%
HAVSP4T0150P		15	20	32	38.4	120%
HAVSP4T0185P		18.5	25	37	44.4	120%
HAVSP4T0220P		22	30	45	54	120%
HAVSP4T0300P		30	40	60	72	120%
HAVSP4T0370P		37	50	75	90	120%
HAVSP4T0450P		45	60	90	108	120%
HAVSP4T0550P		55	75	110	132	120%
HAVSP4T0750P		75	100	157	188.4	120%
HAVSP4T0900P		90	125	180	216	120%
HAVSP4T1100P		110	150	214	256.8	120%
HAVSP4T1320P	132	175	256	307.2	120%	
HAVSP4T1600P	160	200	307	368.4	120%	

## Dimensions

Input Voltage	Commercial Reference	Dimensions(mm)			Mounting Dimensions (mm)				Mounting Hole Diameter (mm)	CAD Diagram
		W	H	D	W1	H1	D1	D2		
AC: 200-240V Three Phase	HAVSP2T0022P	120	215	163	109	204	133	85	5.5	(a)
	HAVSP2T0030P	120	215	163	109	204	133	85	5.5	
	HAVSP2T0040P	120	215	163	109	204	133	85	5.5	
	HAVSP2T0055P	150	259	181	138	248	150	104	5.5	
	HAVSP2T0075P	150	259	181	138	248	150	104	5.5	
	HAVSP2T0110P	205	322	215	188	305	176	130	6.5	
	HAVSP2T0150P	235	370	235	218	350	200	146	7	
	HAVSP2T0185P	235	370	235	218	350	200	146	7	
	HAVSP2T0220P	305	490	275	200	470	270	211	10	
	HAVSP2T0300P	305	490	275	200	470	270	211	10	
	HAVSP2T0370P	320	560	307	197	543	302	240	10	(b)
	HAVSP2T0450P	320	560	307	197	543	302	240	10	
	HAVSP4T0022P	120	215	163	109	204	133	85	5.5	
	HAVSP4T0030P	120	215	163	109	204	133	85	5.5	
AC: 380-440V Three Phase	HAVSP4T0040P	120	215	163	109	204	133	85	5.5	(a)
	HAVSP4T0055P	120	215	163	109	204	133	85	5.5	
	HAVSP4T0075P	120	215	163	109	204	133	85	5.5	
	HAVSP4T0110P	150	259	181	138	248	150	104	5.5	
	HAVSP4T0150P	150	259	181	138	248	150	104	5.5	
	HAVSP4T0185P	205	322	215	188	305	176	130	6.5	
	HAVSP4T0220P	205	322	215	188	305	176	130	6.5	
	HAVSP4T0300P	235	370	235	218	350	200	146	7	
	HAVSP4T0370P	235	370	235	218	350	200	146	7	
	HAVSP4T0450P	305	490	275	200	470	270	211	10	
	HAVSP4T0550P	305	490	275	200	470	270	211	10	(b)
	HAVSP4T0750P	320	560	307	197	543	302	240	10	
	HAVSP4T0900P	320	560	307	197	543	302	240	10	
	HAVSP4T1100P	320	560	307	197	543	302	240	10	
	HAVSP4T1320P	355	678	319	240	659	314	261	11	
	HAVSP4T1600P	355	678	319	240	659	314	261	11	

## CAD Diagrams

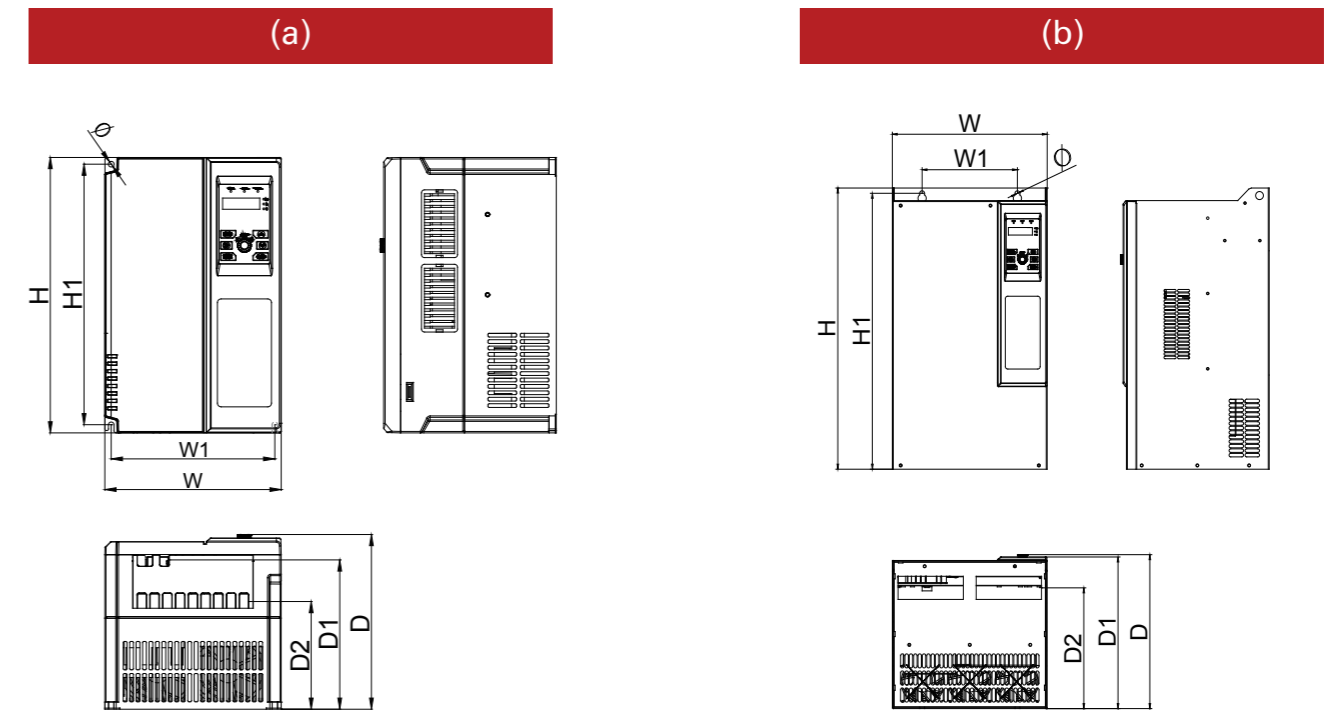

## Wiring Diagrams

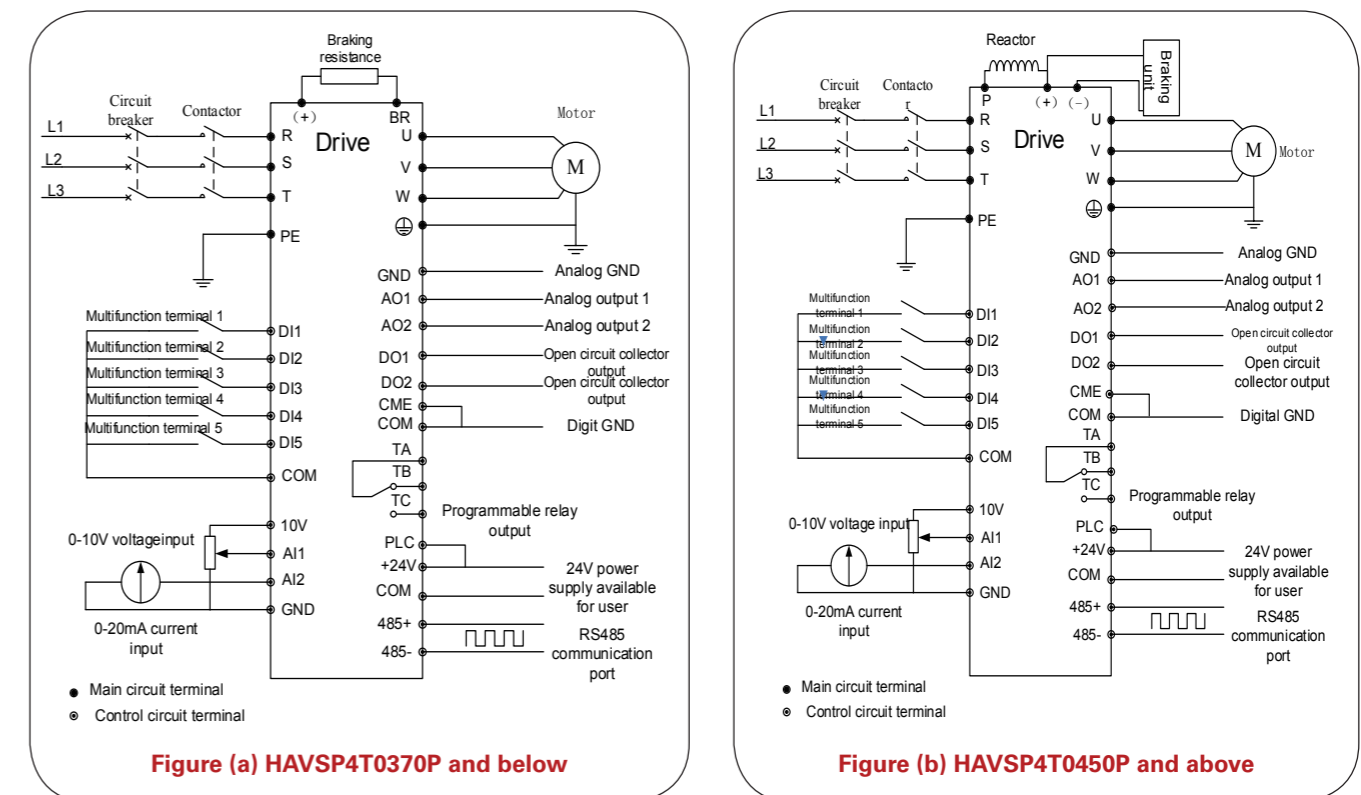
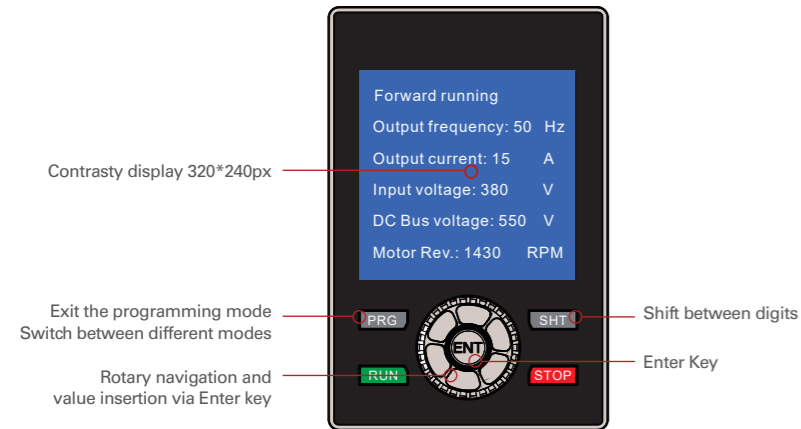

Figure (a) HAVSP4T0370P and below

Figure (b) HAVSP4T0450P and above

## LCD Keypad



Features	Benefits
Display	<ul style="list-style-type: none"> <li>◆ More visible status information</li> <li>◆ Intuitive operation</li> <li>◆ Short commissioning times</li> <li>◆ User-friendly interface</li> </ul>
Rotary navigation	<ul style="list-style-type: none"> <li>◆ Quick navigation and input of values</li> </ul>
Quick commissioning	<ul style="list-style-type: none"> <li>◆ Visible parameter names</li> <li>◆ Possible to commission without documentation</li> <li>◆ Easily copy parameters between multiple drives</li> </ul>

## VSD Accessories

Type	Commercial Reference	Short Description	Applicable Product		Pictures
			Applicable Commercial Reference	Specifications	
IO extension card	HAVXSIO3DIR	IO extension card with 3 Di and 1 relay	HAVSP4T0022P ~ HAVSP4T1600P	4T*: 2.2 - 160kW	
Keypad bracket	HAVXSJPT	Keypad holder for external keypad	HAVSP4T0022P ~ HAVSP4T1600P	4T*: 2.2 - 160kW	
External Keypad	HAVSPLKD**	External keypad	HAVSP4T0022P ~ HAVSP4T1600P	4T*: 2.2 - 160kW	
	HAVSPLCD	LCD keypad	HAVSP4T0022P ~ HAVSP4T1600P	4T*: 2.2 - 160kW	
Keypad cable	HAVXSCAB2	Length 2m	HAVSP4T0022P ~ HAVSP4T1600P	4T*: 2.2 - 160kW	
	HAVXSCAB5	Length 5m	HAVSP4T0022P ~ HAVSP4T1600P	4T*: 2.2 - 160kW	

\*4T: 380V 3 Phase  
 \*\* All VSDs have built-in removable keypad. HAVSPLKD is sold as a spare part.

## Global sales, global service



### Support and Consulting Services



### Training Services



### Spare Parts Services



### Repair Services

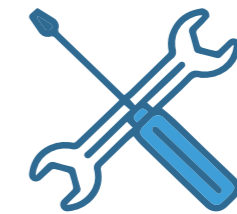

### Contact Himel team

support@himel.com



### Contact local distributor

Company name:

Contact:

Tel:

Email:

Address:



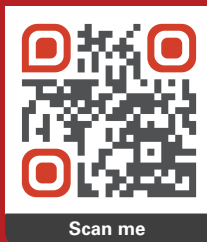

Himel  
[www.himel.com](http://www.himel.com)

May 2021



Copyright © 2021 Himel