

HDGL series

Isolating Switch

User Manual

HIMEL

www.himel.com

Copyright @ himel Co.,Ltd. ♻️ Paper can be recycled

Nov. 2017

Applicable Standard: IEC 60947-3

Please carefully read the user manual before the installation and use of the products, and then keep it properly as backup.

Himel

The Right Choice!

1 Use and environment

1. HDGL series isolating switch for AC 50/60Hz, rated operating voltage up to 690V and below, rated operating current to 3150A. In the industrial enterprise distribution system, the circuit can be used as circuit isolation, and the rated load can also be switched off.

2 Normal working conditions

- 2.1 Ambient air temperature: the upper limit value is not more than +40°C
The lower limit value is not less than -5°C, and the average value in 24h is not more than +35°C;
- 2.2 Installation altitude: no more than 2000m;
- 2.3 Atmospheric conditions: relative humidity of the atmosphere in the surrounding air temperature of +40°C is less than 50%, the relative humidity at low temperature can be high; for example, 20 degrees, relative humidity of 90%, and taking into account the condensation due to temperature changes occurred in the surface of The product;
- 2.4 Pollution level: III;
- 2.5 Installation categories: III & IV;

3 Structure and characteristics

Switch with glass fiber reinforced unsaturated polyester resin manufacturing shell, spring energy storage acceleration mechanism can realize switching on and off, two separate parallel double break contact surface, contact pressure is ensured by leaf springs, automatically determine the limit position of switching, has obvious on-off mark indicating on-off position.

4 Main parameter

4.1 Coding system

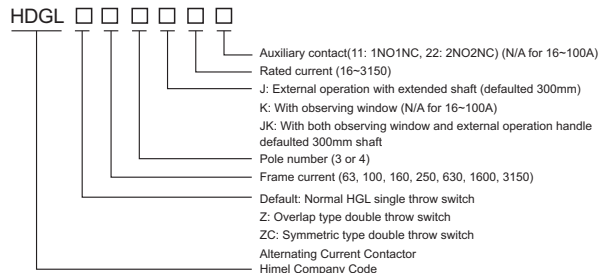

4.2 The main parameters are shown in the following table

| | | | | | | | | |
|--|----------------|-----------------|------------------|-------------------|-------------------|--------------------|--------------|----------------------|
| Conventional free air thermal current (A) | 16 32 63 | 25 40 100 | 80 100 160 | 100 125 250 | 200 400 630 | 315 500 1250 | 1000 1600 | 2000 2500 3150 |
| Power frequency withstand voltage (V) | 2000 | | | | | | | |
| Rated insulation voltage (V) | 800 | | | | | | | |
| Rated impulse withstand voltage U _{imp} | 12kV(2000m) | | | | | | | |
| Rated short-time withstand current (kA) | 2 | 12 | 20 | 25 | 50 | | | |
| Mechanical Endurance | 8000 | | | 5000 | | 3000 | 1000 | |
| Electrical Endurance | 1500 | | 200 | | | 100 | | |

5 Switch outline and mounting dimensions

5.1 HDGL-80~100/3(4) isolating switch shape and mounting dimension and HDGL-63/3(4) isolating switch shape and mounting dimensions

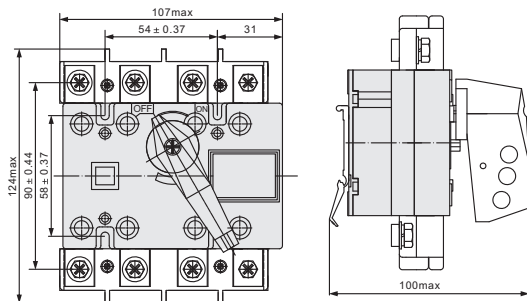

HDGL-80~100/3(4) Shape and mounting dimensions

2

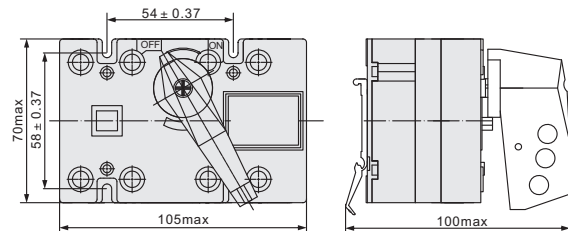

HDGL-16~63/3(4) Isolating switch shape and mounting dimensions

5.2 HDGL-100~630A isolating switch shape and mounting dimensions

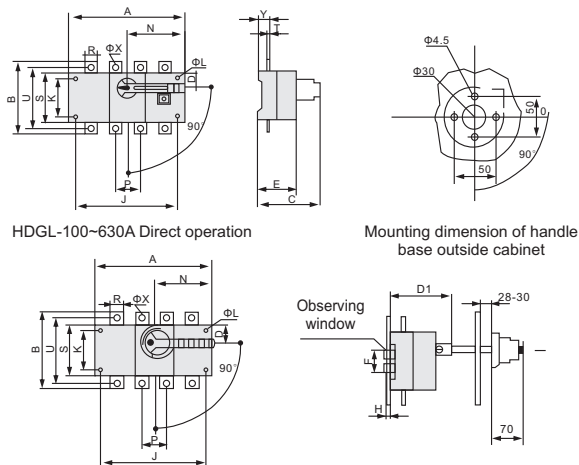

HDGL-100~630A Direct operation

Mounting dimension of handle base outside cabinet

HDGL-100~630A/JK External operation

3

| Specifications | Overall dimensions and mounting dimensions | | | | | | | | | | | | | | | | | | |
|--------------------|--|-----|-----|----|-----|-----|-----|-----|-----|-----|----|----|-----|-----|-----|----|----|-----|----|
| HDGL -100A-630A | A | B | C | D | D1 | E | ΦL | J | K | N | P | R | S | T | U | ΦX | Y | F | H |
| 100A/3 | 140 | 135 | 120 | 27 | 92 | 73 | 5.5 | 120 | 65 | 85 | 36 | 20 | 85 | 3.5 | 115 | 9 | 25 | 53 | 10 |
| 100A/4 | 170 | 135 | 120 | 27 | 92 | 73 | 5.5 | 150 | 65 | 85 | 36 | 20 | 85 | 3.5 | 115 | 9 | 25 | 53 | 10 |
| 125A/3 | 140 | 135 | 120 | 27 | 92 | 73 | 5.5 | 120 | 65 | 85 | 36 | 20 | 85 | 3.5 | 115 | 9 | 25 | 53 | 10 |
| 125A/4 | 170 | 135 | 120 | 27 | 92 | 73 | 5.5 | 150 | 65 | 85 | 36 | 20 | 85 | 3.5 | 115 | 9 | 25 | 53 | 10 |
| 160A/3 | 140 | 135 | 120 | 27 | 92 | 73 | 5.5 | 120 | 65 | 85 | 36 | 20 | 85 | 3.5 | 115 | 9 | 25 | 53 | 10 |
| 160A/4 | 170 | 135 | 120 | 27 | 92 | 73 | 5.5 | 150 | 65 | 85 | 36 | 20 | 85 | 3.5 | 115 | 9 | 25 | 53 | 10 |
| 200A/3 | 180 | 170 | 138 | 35 | 98 | 86 | 6.5 | 160 | 90 | 115 | 50 | 25 | 110 | 3.5 | 140 | 11 | 25 | 80 | 15 |
| 200A/4 | 230 | 170 | 138 | 35 | 98 | 86 | 6.5 | 210 | 90 | 115 | 50 | 25 | 110 | 3.5 | 140 | 11 | 25 | 80 | 15 |
| 250A/3 | 180 | 170 | 138 | 35 | 98 | 86 | 6.5 | 160 | 90 | 115 | 50 | 25 | 110 | 3.5 | 140 | 11 | 25 | 80 | 15 |
| 250A/4 | 230 | 170 | 138 | 35 | 98 | 86 | 6.5 | 210 | 90 | 115 | 50 | 25 | 110 | 3.5 | 140 | 11 | 25 | 80 | 15 |
| 315A/3 | 230 | 240 | 175 | 50 | 135 | 110 | 7 | 210 | 140 | 145 | 65 | 32 | 160 | 4.5 | 206 | 11 | 37 | 104 | 20 |
| 315A/4 | 290 | 240 | 175 | 50 | 135 | 110 | 7 | 270 | 140 | 145 | 65 | 32 | 160 | 4.5 | 206 | 11 | 37 | 104 | 20 |
| 400A/3 | 230 | 240 | 175 | 50 | 135 | 110 | 7 | 210 | 140 | 145 | 65 | 32 | 160 | 4.5 | 206 | 11 | 37 | 104 | 20 |
| 400A/4 | 290 | 240 | 175 | 50 | 135 | 110 | 7 | 270 | 140 | 145 | 65 | 32 | 160 | 4.5 | 206 | 11 | 37 | 104 | 20 |
| 500A/3 | 230 | 260 | 175 | 50 | 135 | 110 | 7 | 210 | 140 | 145 | 65 | 40 | 160 | 6 | 220 | 13 | 37 | 104 | 20 |
| 500A/4 | 290 | 260 | 175 | 50 | 135 | 110 | 7 | 270 | 140 | 145 | 65 | 40 | 160 | 6 | 220 | 13 | 37 | 104 | 20 |
| 630A/3 | 230 | 260 | 175 | 50 | 135 | 110 | 7 | 210 | 140 | 145 | 65 | 40 | 160 | 6 | 220 | 13 | 37 | 104 | 20 |
| 630A/4 | 290 | 260 | 175 | 50 | 135 | 110 | 7 | 270 | 140 | 145 | 65 | 40 | 160 | 6 | 220 | 13 | 37 | 104 | 20 |

5.3 HDGL-800~1600 Isolating switch shape and mounting dimensions

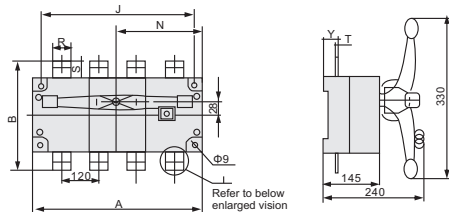

HDGL-800~1600A

Enlarged vision

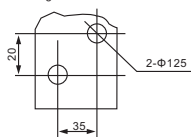

800~1000A

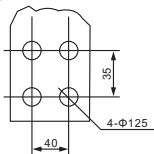

1250~1600A

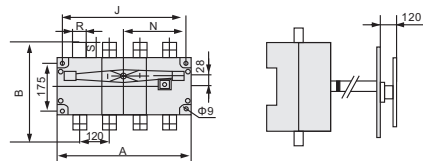

HDGL-800~1600A/J

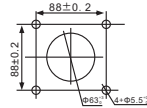

A type: Mounting dimension of outside handle base

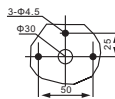

B type: Mounting dimension of outside handle base

Note: 1. A type handle, length 405; B type handle, length 330

2. Defaulted A type handle, B type handle can be customized individually

| Specifications | Overall dimensions and mounting dimensions | | | | | | | |
|-----------------|--|-----|-----|-----|----|----|----|----|
| HDGL-800A~1600A | A | B | J | N | R | S | T | Y |
| 800~1000A/3 | 378 | 312 | 353 | 185 | 60 | 56 | 8 | 48 |
| 800~1000A/4 | 498 | 312 | 473 | 245 | 60 | 56 | 8 | 48 |
| 1250A/3 | 378 | 360 | 353 | 185 | 80 | 78 | 8 | 48 |
| 1250A/4 | 498 | 360 | 473 | 245 | 80 | 78 | 8 | 48 |
| 1600A/3 | 378 | 360 | 353 | 185 | 80 | 78 | 10 | 49 |
| 1600A/4 | 498 | 360 | 473 | 245 | 80 | 78 | 10 | 49 |

5.4 HDGL-2000A~3150A Isolating switch shape and mounting dimensions

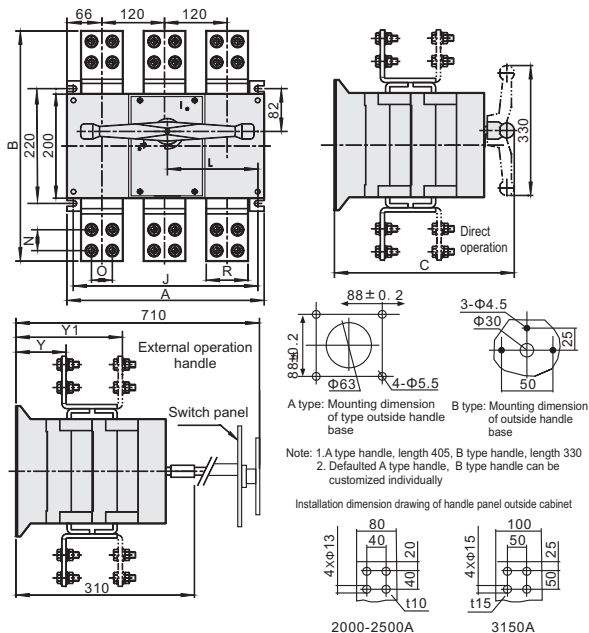

| Specification current | HDGL-2000,2500,3150 Installation dimensions of switchgear and switchgear inside cabinet (mm) | | | | | | | | | |
|-----------------------|--|-----|-----|-------|-----|----|----|-----|----|-----|
| | A | B | C | L | J | N | O | R | Y | Y1 |
| HDGL-2000A/3 | 378 | 440 | 374 | 173.5 | 350 | 40 | 40 | 80 | 92 | 225 |
| HDGL-2500A/3 | 378 | 440 | 374 | 173.5 | 350 | 40 | 40 | 80 | 92 | 225 |
| HDGL-3150A/3 | 378 | 510 | 374 | 173.5 | 350 | 50 | 50 | 100 | 76 | 245 |
| HDGL-2000A/4 | 500 | 440 | 374 | 235 | 473 | 40 | 40 | 80 | 92 | 225 |
| HDGL-2500A/4 | 500 | 440 | 374 | 235 | 473 | 40 | 40 | 80 | 92 | 225 |
| HDGL-3150A/4 | 500 | 510 | 374 | 235 | 473 | 50 | 50 | 100 | 76 | 245 |

5.5 HDGLZ-80~100A Isolating switch shape and mounting dimensions

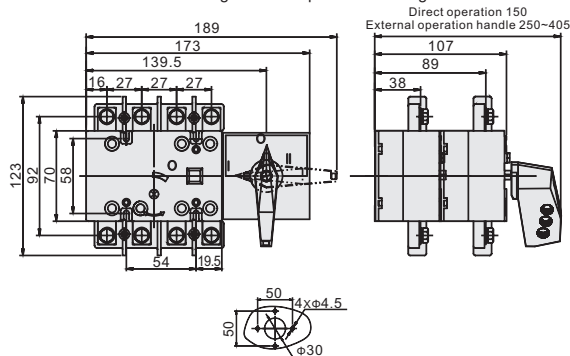

Installation dimension drawing of handle panel outside cabinet

5.6 HDGLZ-100~1600A Isolating switch shape and mounting dimensions

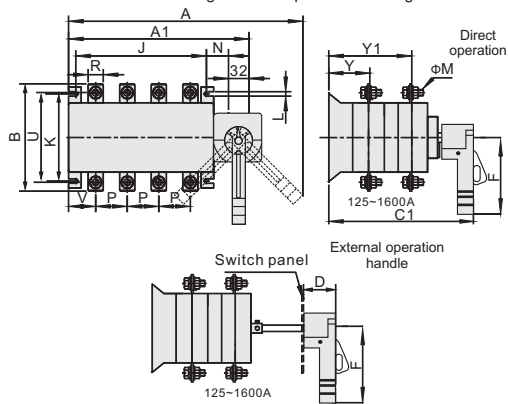

| Specification current | Shape and mounting dimensions (mm) | | | | | | | | | | | | | | | | |
|-----------------------|------------------------------------|-----|-----|-----|-----|-----|-----|-----|-----|------|-----|----|-----|----|----|-----|-----|
| | A | A1 | B | C1 | D | F | J | K | L | N | P | R | U | V | ΦM | Y | Y1 |
| 100~160A/3 | 265 | 196 | 135 | 211 | 85 | 115 | 120 | 95 | 7 | 29.5 | 36 | 20 | 115 | 29 | 8 | 55 | 122 |
| 100~160A/4 | 295 | 226 | 135 | 211 | 85 | 115 | 150 | 95 | 7 | 29.5 | 36 | 20 | 115 | 29 | 8 | 55 | 122 |
| 200~250A/3 | 310 | 235 | 170 | 240 | 85 | 115 | 160 | 115 | 8.5 | 29.5 | 50 | 25 | 142 | 37 | 10 | 65 | 148 |
| 200~250A/4 | 360 | 288 | 170 | 240 | 85 | 115 | 210 | 115 | 8.5 | 29.5 | 50 | 25 | 142 | 37 | 10 | 65 | 148 |
| 315~400A/3 | 405 | 305 | 240 | 312 | 85 | 143 | 210 | 180 | 10 | 43 | 65 | 30 | 205 | 48 | 10 | 85 | 200 |
| 315~400A/4 | 460 | 365 | 240 | 312 | 85 | 143 | 275 | 180 | 10 | 43 | 65 | 30 | 205 | 48 | 10 | 85 | 200 |
| 500~630A/3 | 405 | 305 | 260 | 312 | 85 | 143 | 210 | 180 | 10 | 43 | 65 | 40 | 220 | 48 | 12 | 86 | 201 |
| 500~630A/4 | 460 | 365 | 260 | 312 | 85 | 143 | 275 | 180 | 10 | 43 | 65 | 40 | 220 | 48 | 12 | 86 | 201 |
| 800~1000A/3 | 585 | 480 | 320 | 410 | 105 | 165 | 350 | 220 | 11 | 50 | 120 | 60 | 246 | 73 | 10 | 115 | 260 |
| 800~1000A/4 | 715 | 600 | 320 | 410 | 105 | 165 | 473 | 220 | 11 | 50 | 120 | 60 | 246 | 73 | 10 | 115 | 260 |
| 1250A/3 | 585 | 480 | 340 | 410 | 105 | 165 | 350 | 220 | 11 | 50 | 120 | 80 | 246 | 73 | 12 | 115 | 260 |
| 1250A/4 | 715 | 600 | 340 | 410 | 105 | 165 | 473 | 220 | 11 | 50 | 120 | 80 | 246 | 73 | 12 | 115 | 260 |
| 1600A/3 | 585 | 480 | 340 | 410 | 105 | 165 | 350 | 220 | 11 | 50 | 120 | 80 | 246 | 73 | 12 | 116 | 262 |
| 1600A/4 | 715 | 600 | 340 | 410 | 105 | 165 | 473 | 220 | 11 | 50 | 120 | 80 | 246 | 73 | 12 | 116 | 262 |

5.7 HDGLZ-2000~3150A Isolating switch shape and mounting dimensions

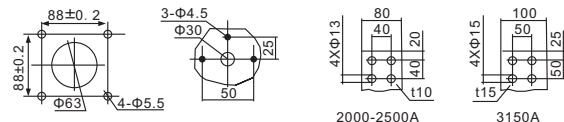
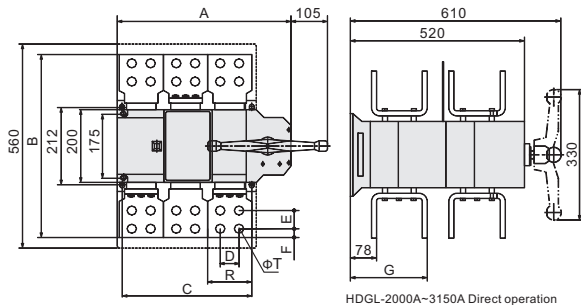

A type: Mounting dimension of outside handle base

B type: Mounting dimension of outside handle base

2000-2500A

3150A

Note: 1. A type handle, length 405, B type handle, length 330;

2. Defulted A type handle, B type handle can be customized individually

| Specification current | Shape and mounting dimensions (mm) | | | | | | | | |
|-----------------------|------------------------------------|-----|-----|----|----|----|-----|----|-----|
| | A | B | C | D | E | F | G | ΦT | R |
| 2000A/3 | 479 | 418 | 353 | 40 | 40 | 20 | 220 | 10 | 80 |
| 2000A/4 | 598 | 418 | 473 | 40 | 40 | 20 | 220 | 10 | 80 |
| 2500A/3 | 479 | 418 | 353 | 40 | 40 | 20 | 220 | 10 | 80 |
| 2500A/4 | 598 | 418 | 473 | 40 | 40 | 20 | 220 | 10 | 80 |
| 3150A/3 | 479 | 492 | 353 | 50 | 50 | 25 | 320 | 15 | 100 |
| 3150A/4 | 598 | 492 | 473 | 50 | 50 | 25 | 320 | 15 | 100 |

5.8 HDGLZC-16~100A Isolating switch shape and mounting dimensions

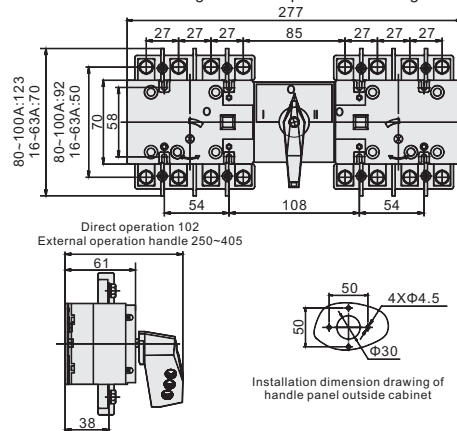

5.9 HDGLZC-100~1600A Isolating switch shape and mounting dimensions

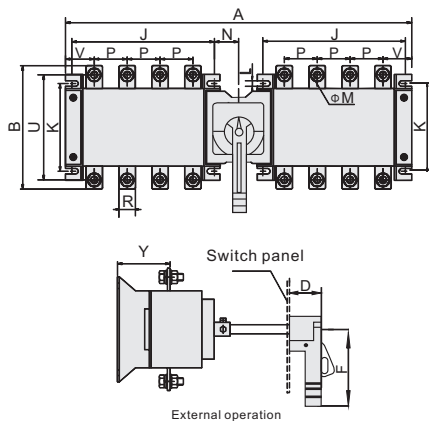

| Specification current | Shape and mounting dimensions (mm) | | | | | | | | | | | | | | |
|-----------------------|------------------------------------|-------|-----|-----|-----|-----|-----|-----|------|-----|----|-----|----|----|-----|
| | A | B | C | D | F | J | K | L | N | P | R | U | V | φM | Y |
| 100~160A/3 | 320 | 135.5 | 144 | 85 | 115 | 120 | 95 | 7 | 29.5 | 36 | 20 | 115 | 29 | 8 | 55 |
| 100~160A/4 | 380 | 135.5 | 144 | 85 | 115 | 150 | 95 | 7 | 29.5 | 36 | 20 | 115 | 29 | 8 | 55 |
| 200~250A/3 | 400 | 172 | 158 | 85 | 115 | 160 | 115 | 8.5 | 29.5 | 50 | 25 | 142 | 37 | 10 | 65 |
| 200~250A/4 | 503 | 172 | 158 | 85 | 115 | 210 | 115 | 8.5 | 29.5 | 50 | 25 | 142 | 37 | 10 | 65 |
| 315~400A/3 | 545 | 240 | 195 | 85 | 143 | 210 | 180 | 10 | 43 | 65 | 30 | 205 | 48 | 10 | 85 |
| 315~400A/4 | 660 | 240 | 195 | 85 | 143 | 275 | 180 | 10 | 43 | 65 | 30 | 205 | 48 | 10 | 85 |
| 500~630A/3 | 545 | 260 | 195 | 85 | 143 | 210 | 180 | 10 | 43 | 65 | 40 | 220 | 48 | 12 | 86 |
| 500~630A/4 | 660 | 260 | 195 | 85 | 143 | 275 | 180 | 10 | 43 | 65 | 40 | 220 | 48 | 12 | 86 |
| 800~1000A/3 | 840 | 320 | 258 | 105 | 165 | 350 | 220 | 11 | 50 | 120 | 60 | / | 73 | 10 | 115 |
| 800~1000A/4 | 1080 | 320 | 258 | 105 | 165 | 473 | 220 | 11 | 50 | 120 | 60 | / | 73 | 10 | 115 |
| 1250A/3 | 840 | 340 | 258 | 105 | 165 | 350 | 220 | 11 | 50 | 120 | 80 | / | 73 | 12 | 115 |
| 1250A/4 | 1080 | 340 | 258 | 105 | 165 | 473 | 220 | 11 | 50 | 120 | 80 | / | 73 | 12 | 115 |
| 1600A/3 | 840 | 340 | 258 | 105 | 165 | 350 | 220 | 11 | 50 | 120 | 80 | / | 73 | 12 | 116 |
| 1600A/4 | 1080 | 340 | 258 | 105 | 165 | 473 | 220 | 11 | 50 | 120 | 80 | / | 73 | 12 | 116 |

6 HDGL(Z)(C) Assembly demonstration

6.1 HDGL assembly demonstration

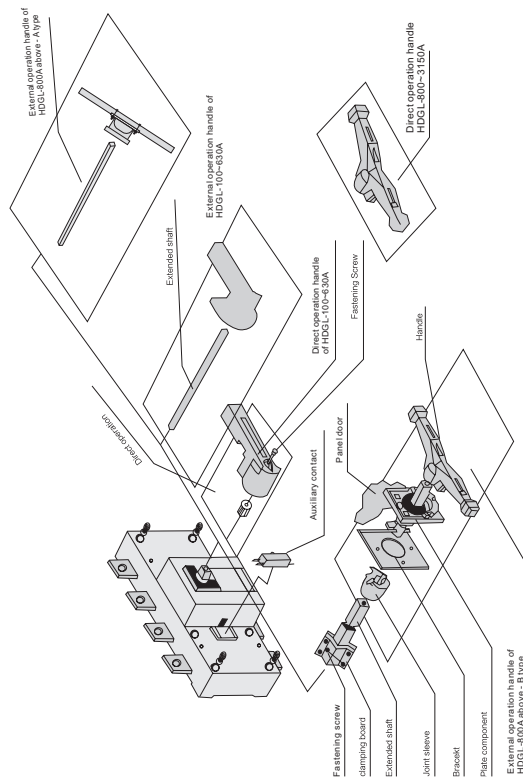

6.2 HDGLZ assembly demonstration

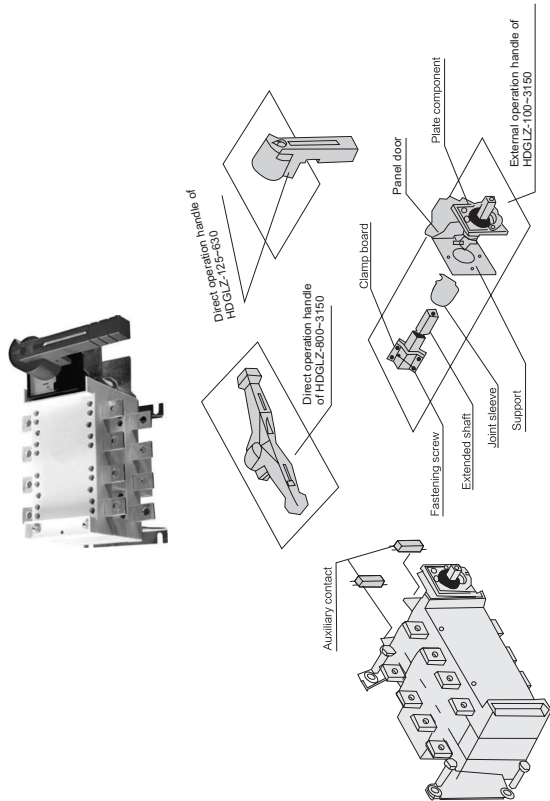

12

6.3 HDGLZC assembly demonstration

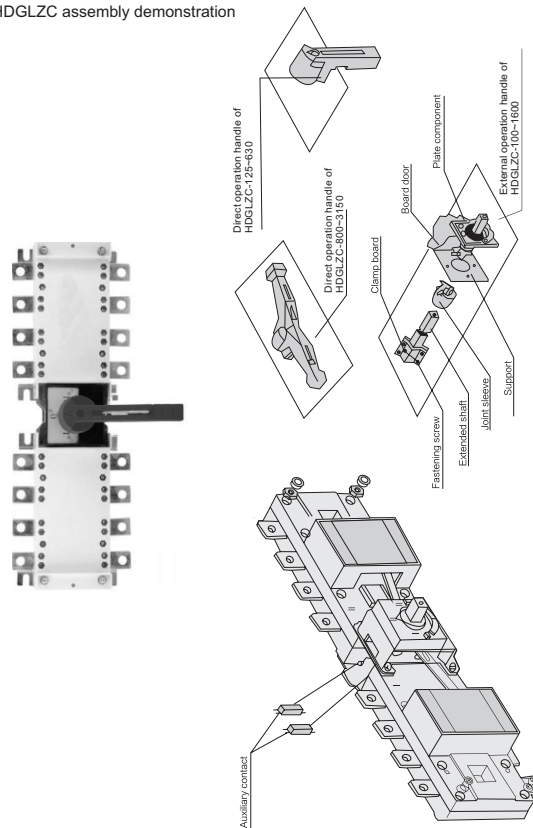

13

7 Installation diagram

7.1 Schematic diagram of HDGL(Z)(C)-16~100A direct operation handle installation and cabinet installation.

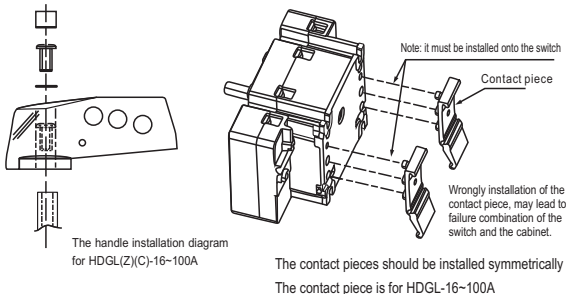

Direct operation

7.2 Schematic diagram of HDGL(Z)(C)-16~100A external operation handle installation and cabinet installation.

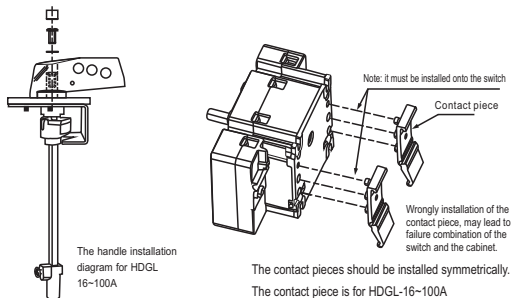

External operation

14

7.3 HDGL(Z)(C)-100A~630A The schematic diagram of the direct operation and installation of the isolating switch cabinet puts the switch in the disconnection state. It is fixed on the mounting board inside the cabinet and the handle is installed on the square shaft so that the handle is in the horizontal position.

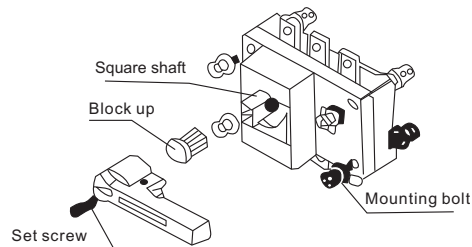

7.4 HDGL-100A~630A Schematic diagram of external operation and installation of Disconnector

- (1) Put the switch in the disconnection state and fix it on the mounting board inside the cabinet, and measure the distance from the top of the switch square shaft to the inside of the cabinet door L.
- (2) Saw off the long shaft

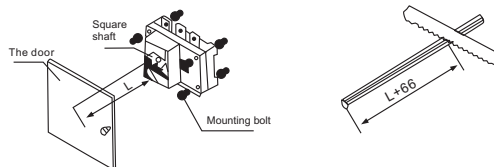

15

(3) If you need the doors lockable, please use the 2 black cotter accessories in the package, and nail them into the extended shaft. Make sure the nail in position and firm. Make the head end cotter lower than the other. No need to use cotters if you do not want to lock the cabinet.

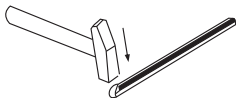

(4) Tap the contact point between door and shaft head, to determine the drilling center.

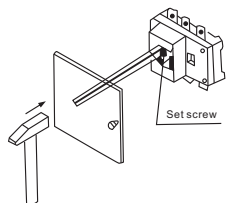

(5) Drill hole $\Phi 6$, then enlarge to $\Phi 30$. (6) Locate the drilling hole with end caps $4-\Phi 4$.

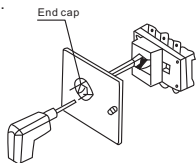
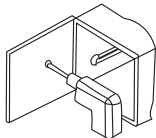

(7) Knock off the center part of end caps (8) Unscrew the 2 self tapping screw ST4X 16 at the handle base, and press the handle to prevent internal component spring out. Refer to the below instruction, to fasten the end caps and shaft with self tapping screws. And make sure the handle ON/OFF indicator conform to the switch

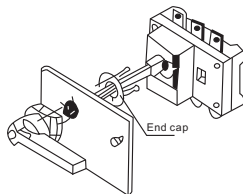
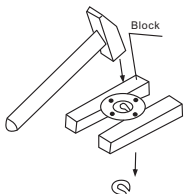

7.5 HGL(Z)(C)-800~3150 Schematic diagram of direct operation handle installation: Disconnect the switch, then fix the switch onto the shelf of the cabinet, and then install the handle onto the square shaft, switch the handle to horizontal position, and finally fasten the handle onto shaft by screw.

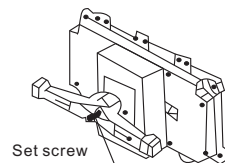

7.6 HDGL(Z)(C)-800~3150 Schematic diagram of B type external operation handle installation.

(1) Put the switch in the disconnection state, and measure the distance from the top of the switch square shaft to the inside of the cabinet door L. (2) Screw all the screw of the positioning shaft into the extended shaft, and measure the value of L according to the figure.

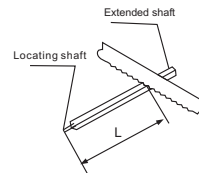
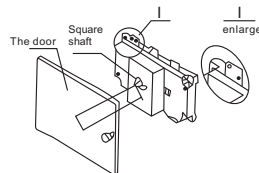

(3) The extended shaft and the switch square shaft are connected with the splint, and by adjusting the positioning shaft and make its head contact to the door and then tap the center to determine the drilling center by a hammer.

(4) Remove locating shaft and drill $\Phi 6$, then enlarge to $\Phi 30$

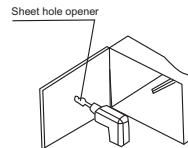
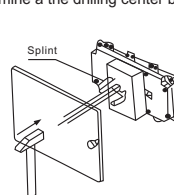

- (5) Put the panel module onto cabinet door, fasten the connecting sleeve to the extended shaft, make the pointer of panel module direction same as the sleeve show. Then close the cabinet, and drill 3-5.5.

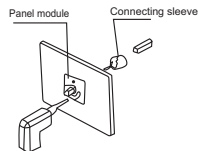

- (6) Install panel module and bracket (right hand door bracket, U type mouth toward right, left hand door bracket, U type mouth toward left) with 3-M5X16 on the door, and the locknut is fastened on the back.

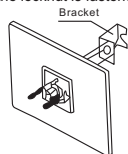

- (7) Stick the Label to the panel as shown.

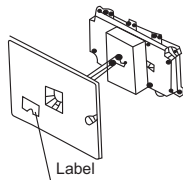

- (8) Fit the handle in the as per below position on the square shaft so that the handle arrow points to the panel indication and then fasten with the M4X25 screw.

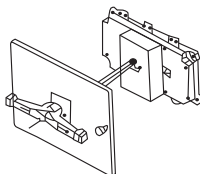

7.7 HDGL(Z)(C)-800-3150 A type external operation handle: for installing method please refer to 6.6, and for cabinet hole drilling, please refer to 5.3.

6.8 HDGL(Z)(C)-125-630A Schematic diagram of external operation and installation of Disconnecter

- (1) The switch I and II are placed in the disconnection state, and measure the distance from the top of the switch square shaft to the inside of the cabinet door. The distance is L.

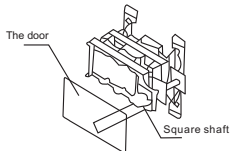

- (2) Screw all the screw of the positioning shaft into the extended shaft, and then cut the L value according to the diagram.

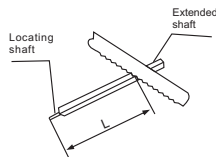

- (3) The extended shaft and the switch square shaft are connected via fastening screw onto splint and adjust the positioning axis to make its head contact the door splint, and determine the drilling center by tapping hammer.

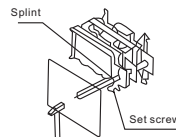

- (4) Remove locating shaft and drill $\Phi 6$, and then enlarge to $\Phi 30$.

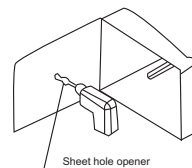

- (5) Put the panel module onto cabinet door, and fix the connecting sleeve onto shaft by M4*16 screw, make the rib direction on the sleeve vertical to the panel module pointer. Left hand door rib toward right, and right hand door rib toward left. Close the door, and drill 3-4.5.

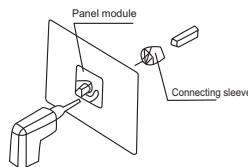

- (6) Install the panel module and bracket (right hand door bracket, U type mouth to the right, left hand door bracket, U type mouth to the left) with 3- M4x16 screws to the cabinet door, and fix with back nut.

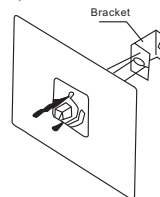

- (7) Attach the logo to the panel as shown.

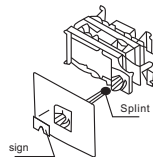

- (8) Fix the handle as per below position on the square shaft so that the handle arrow points to the panel pointer, and the M4x25 fastening screws are fastened.

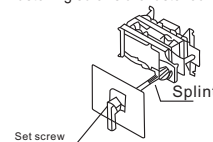

8 Use and maintenance

- 8.1 The switch should be installed vertically. Check whether the contents of the nameplate comply with the use before installation. Make sure the switch is at disconnected position. Pull switch handle. When the handle arrow points to "O", and the observing window also shows "O". The switch is disconnected. When the handle arrow points to "I", the observing window also shows "I", and the switch is closed.
- 8.2 The terminal and wiring nut line of the switch should be wrapped insulation, to prevent the Interphase short circuit.
- 8.3. For outside operating switch, if the long shaft and handle hole different axis, remember not to pull the shaft so as not to damage the internal parts. Shall adjust the switch position To make them coaxial.
- 8.4 Switch should be maintained every six months or so. If rotating part is not flexible and can be painted with MP-3 grease. Check if the fasteners are loose. And for different circumstances To maintain, if the damage is serious, should stop using.