

Install method

connect the line

- When installing dryer without junction box, you should install above the right side of dryer, two-hole standard outlet corresponds to hand dryer. The distance should be 20-50cm.
- Please embed junction box without cover in the installation location when directly connecting power cord is needed. Other -wise, power cord will be forced out of body and can not be properly installed.

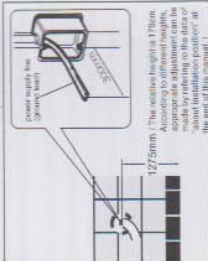

1

Shell remove

- Using Allen wrench from accessories bag to remove 2 countersunk screws from body shell.
- Pull the shell upward by hands to remove.
- Keeping the shell carefully avoiding scratching.

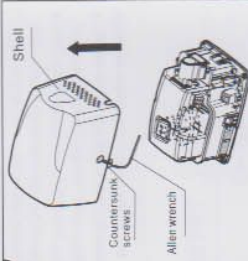

2

Machine installation

As figure showed, the machine to be fixed on the wall by screws.
The machine has been equipped with a power cord. If needing junction box for installation, the power cord must be removed.

As figure showed, poking the thread hole of junction box by screw drivers, wire drawn out through thread hole to the terminal blocks to connect.

- When connecting, the wire length should exceed 2cm to terminal block. Fire line must be connected at L position of terminal blocks, nul line connected at N position, earth line connected at Ⓧ.

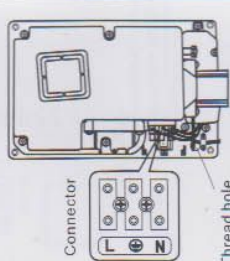

3

Shell installation

- Tighten the 2 countersunk screws on the shell.

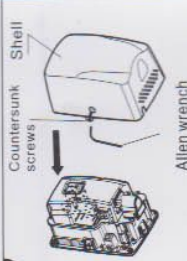

Test run

Steps	Confirm information	Check & Notice
1	Shake the machine gently without shaking	It will occur staking and noisy when the machine doesn't install firmly
2	Confirm the power and voltage	It will burn out machines or cause human accidents if the power use incorrect
3	Switch on the power	Power socket must be match the machine plug Please check the power when the indicator light not bright
4	Slid in your hands to drying	Please confirm whether your hands are far away from the sensor parts if there is no wind blowing out

Daily use and maintenance

External maintenance

- Screw with a soft dry cloth or towel Sasafrafas. Please use neutral detergent. Please don't use organic solvents, acid or alkali toilet cleaner, cleaning brush etc.
- Otherwise, the machine will destroy machine surface finish or produce discoloration.
- If using a chemical cloth, make sure that the use of attention.

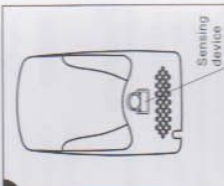

1



2



3

Slowly moving up the back of the hand before and after

Pain of the hand before and after slowly moving upwards

Mutual hands

Packing list

main machine	1
5×25mm self tapping screw	4
5mm expansion pipe	4
User manual	1
Allen wrench	1

HAND DRYER

USER MANUAL

Specification

Voltage	AC220-240V~	Motor	Brush motor
Phase	Single-phase	Sensing distance	15-20cm
Input	1150-1350W	Protection class	IPX1
Wind speed	60m/s	Appearance size	260x180x152mm
Heating power	650-750W	N.W	3.0kg



WARNING

If you don't use this unit properly or follow the safety guidelines care fully, it would lead to serious personal injury or property damage

- Do not open the front panel. Otherwise, this may get an electric shock.
- Do not let children hang from the unit. otherwise, this may cause the unit to drop.
- Do not allow the unit get wet. otherwise, it will cause electric shock.

Do not use in a wet environment, for example, near the bathroom where it may get the direct water and the places where the condensation may form. Otherwise, this may cause electric shock and unit malfunction.

Do not modify and disassemble the unit unnecessarily. Otherwise this may cause a fire, electric shock, or personal injury.

Rated power is required if power tolerance is over +/-10%, there will be breakdown if using incorrect power supply, fire, electric shock and machine malfunction will happen.

Please use dedicated socket with insru with insru if using together with other appliances, the socket may cause abnormal heat leading to fire.

Power must be cut off when maintenance to prevent the risk of electric shock.

Air filter must be installed.

If the machine doesn't work or have abnormal conditions, please cut off power to prevent accidents; and close leakage circuit breaker and ask supplier to check and repair, or it may lead to fire because of electricity leakage and short circuit.

Machine must have reliable ground connection.

Attention when installation:
Do not install when the machine are power connected.
This appliance is not intended for use by persons (including children) with reduced physical, sensory or mental capabilities or lack of experience and knowledge, unless they have been given supervision or instruction concerning use of the appliance by a person responsible for their safety.
If the cord is damaged, it must be replaced by the manufacturer, its service agent or similarly qualified persons in order to avoid a hazard.

For additional protection, the installation of a residual current device (RCD) having a rated residual operating current not exceeding 30mA is advisable in the electrical circuit supplying the bathroom. Ask your installer for advice.



Environmental Protection
Waste electrical products should not be disposed of with household waste.
Please recycle where facilities exist.
Check with your Local Authority or retailer for recycling advice.

Feature

- No touch hand drying ensures complete hygiene
- No need paper towels, ease of maintenance
- Stainless steel shell, solid and beautiful
- Auto-stop function, the built-in timer will stop the unit after 40 seconds.
- The machine equipped with automatic heating system, when temperature was cold, automatically open the heating system, when the temperature was hot, the heating system, automatic shutdown.

Name of each part

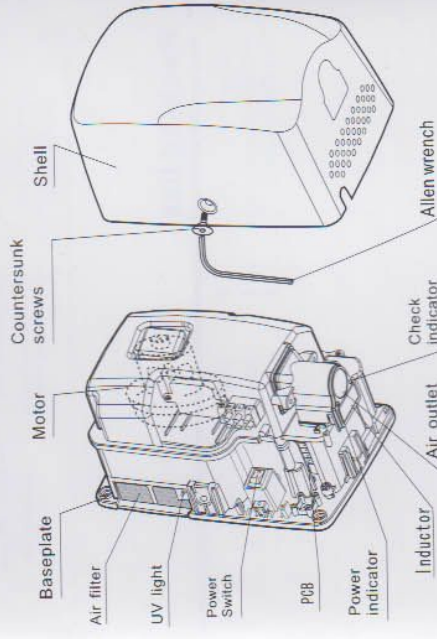

Electrical diagram

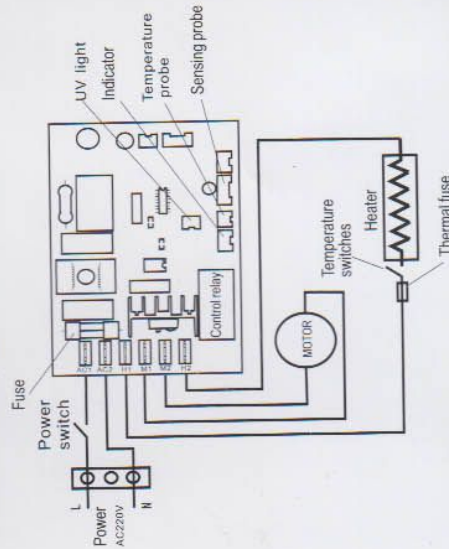

Precautions before installation and Installation location

- Do not install in the following places (otherwise may cause malfunction).
 - Place with temperature below 10°C or above 40°C
 - Place directly sprinkled by water
 - Place with direct sunlight, strong light
 - Place easy for condensation
 - Place filled with corrosive, oxidizing and reducing gas
 - Place with altitude over the range of 0 ~ 2000m
- Installation location
 - The following picture shows the recommended location. (If there is floor or obstacles below the hand dryer, the distance between machine and floor or obstacles should be at least 400mm.)
 - Keep the right side of dryer away from mirror or wall for the water droplets may splash out when you dry hands. (the distance should be 100mm above)
 - Please avoid the place easy to meet people and easy to encounter doors.
 - Please select flat wall to install this product.

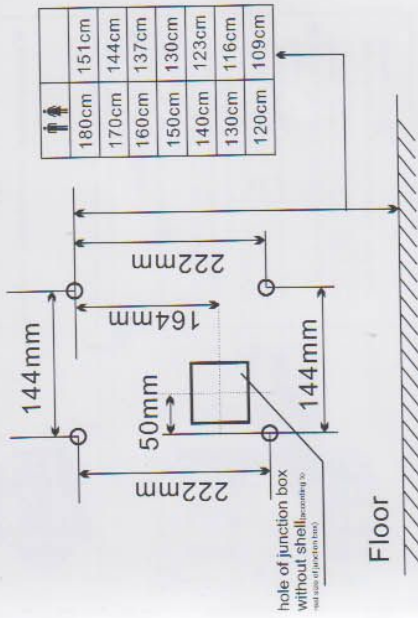

• Power cord should be 1.0mm² - 1.5mm²